

**BRAMALEA ROAD CORRIDOR IMPROVEMENTS, MUNICIPAL CLASS
ENVIRONMENTAL ASSESSMENT STUDY**

Appendix E Natural Environment Report

Appendix E Natural Environment Report



To: Paula Hohner
Stantec - London

From: Janice Ball
Stantec - Waterloo

File: Bramalea Road Improvements
165010590

Date: December 19, 2018

Reference: Natural Environmental Assessment for the Bramalea Road Schedule “C” Class Environmental Assessment

This Natural Environment Assessment provides a summary of the existing conditions for the Bramalea Road Schedule “C” Class Environmental Assessment (EA) road widening project in Brampton, Ontario. The Project Study Area extends 120 m on either side of Bramalea Road from Queen St. E. to approximately 790 m south of Highway 407 (**Figures 1.1-1.7**).

BACKGROUND INFORMATION

The following information sources were reviewed to identify natural heritage features, provincially rare species and Species at Risk (SAR), which may be present in the Project Study Area:

- Natural Heritage Information Centre Data (MNRF 2018a)
- Land Information Ontario Natural Heritage Mapping Tool (MNRF 2018b)
- Species at Risk in Ontario List (MNRF 2018c)
- 2nd Ontario Breeding Bird Atlas (Cadman et al. 2007)
- Atlas of Mammals of Ontario (Dobbyn 1994)
- Ontario Reptile and Amphibian Atlas internet database (Ontario Nature 2018)

There were no recent occurrences (within the past 20 years) of provincially rare species or SAR in the Study Area in the NHIC database. There were also no significant natural heritage features identified in the Study Area according to Land Information Ontario mapping (MNRF 2018b).

The background review of wildlife atlases identified thirteen (13) provincially rare species that have been previously documented or have potential to occur within the Project Area. Of these, eight (8) species are provincially listed as threatened or endangered. A habitat assessment was completed for these species in **Table 1**.

Table 1: Background Review of Terrestrial SAR and Provincially Rare Species

Common Name	Scientific Name	SRANK	Provincial Status (COSSARO)	National Status (COSEWIC)	Source	Potential Habitat in the Study Area? (Y/N)
AMPHIBIANS						
Western Chorus Frog	<i>Pseudacris triseriata</i>	S3	NAR	THR-THR	ORAA	N – No suitable aquatic habitat

Reference: Natural Environmental Assessment for the Bramalea Road Schedule “C” Class Environmental Assessment

REPTILES						
Snapping Turtle	<i>Chelydra serpentina</i>	S3	SC	SC	ORAA	N – No suitable aquatic habitat
BIRDS						
Bank Swallow	<i>Riparia riparia</i>	S4B	THR	THR-NS	OBBA	N – No suitable eroding banks
Barn Swallow	<i>Hirundo rustica</i>	S4B	THR	THR-NS	OBBA	N – No suitable nesting structures
Chimney Swift	<i>Chaetura pelagica</i>	S4B, S4N	THR	THR-THR	OBBA	N – No suitable nesting structures
Common Nighthawk	<i>Chordeiles minor</i>	S4B	SC	THR	OBBA	Y – Potential suitable habitat in the cultural meadow communities
Eastern Meadowlark	<i>Sturnella magna</i>	S4B	THR	THR-NS	OBBA	Y – Potential suitable habitat in the cultural meadow communities
Eastern Wood-Pewee	<i>Contopus virens</i>	S4B	SC	SC	OBBA	N – No deciduous forests
Wood Thrush	<i>Hylocichla mustelina</i>	S4B	SC	THR	OBBA	N – No mature deciduous forests
MAMMALS						
Eastern Small-footed Myotis	<i>Myotis leibii</i>	S2S3	END	Not listed	AMO	N – No suitable roosting trees
Little Brown Myotis	<i>Myotis lucifugus</i>	S4	END	END-END	AMO	N – No suitable roosting trees
Northern Myotis	<i>Myotis septentrionalis</i>	S3?	END	END-END	AMO	N – No suitable roosting trees
Tri-colored Bat	<i>Perimyotis subflavus</i>	S3?	END	END-END	AMO	N – No suitable roosting trees

Reference: Natural Environmental Assessment for the Bramalea Road Schedule “C” Class Environmental Assessment

INVERTEBRATES						
Monarch	<i>Danaus plexippus</i>	S3	NAR	NAR	MNRF	Y – Potential suitable habitat in the cultural meadow communities
Rusty-patched Bumble Bee	<i>Bombus affinis</i>	S1	END	END-END	MNRF	Y – Potential suitable habitat in the cultural meadow communities
PLANT SPECIES						
Butternut	<i>Juglans cinerea</i>	S3	END	END	MNRF	N – Not observed during the tree inventory

AMO: Atlas of the Mammals of Ontario
 COSSARO: Committee on the Status of Species at Risk in Ontario
 COSEWIC: Committee on the Status of Endangered Wildlife in Canada
 END: Endangered - a species facing imminent extinction or extirpation
 MNRF: Species at Risk in Ontario Range Maps
 NAR: Not at Risk
 NHIC: Natural Heritage Information Centre
 OBBA: Ontario Breeding Bird Atlas
 ORAA: Ontario Reptile and Amphibian Atlas
 THR: Threatened - a species that is at risk of becoming endangered
 SC: Special Concern - a species with characteristics that make it sensitive to human activities or natural events
 S1: Critically Imperiled - Critically imperiled in the province (often 5 or fewer occurrences)
 S2: Imperiled - Imperiled in the province, few populations (often 20 or fewer)
 S3: Vulnerable - Vulnerable in the province, relatively few populations (often 80 or fewer)
 S4: Apparently Secure - Uncommon but not rare
 S5: Secure - Common, widespread, and abundant in the province
 S?: Rank Uncertain
 S#B: Breeding status rank

TERRESTRIAL HABITAT ASSESSMENT

The purpose of the terrestrial habitat assessment was to identify natural and anthropogenic vegetation and wildlife habitat features in the Project Site and evaluate their significance. The work included Ecological Land Classification (ELC) of vegetation communities using the ELC system for Southern Ontario (Lee et al. 1998), a detailed tree inventory and bat roost assessment, and identification of wildlife habitat features according to the Significant Wildlife Habitat Criteria Schedules for EcoRegion 7E.

VEGETATION COMMUNITY ASSESSMENT

Vegetation communities were first delineated on aerial imagery and then verified in the field during the tree inventory on November 21, 22 and 27, 2018. Provincial significance of vegetation communities was based on the rankings assigned by the Natural Heritage Information Centre (MNRF 2018a). ELC mapping of the Project Area was completed at a scale of 1:2,000 and is shown on **Figures 1.1-1.7**.

Design with community in mind

Reference: Natural Environmental Assessment for the Bramalea Road Schedule “C” Class Environmental Assessment

The vegetation community types are briefly described below in **Table 2**. All ELC vegetation community types are common in Ontario.

Table 2: Ecological Land Classification Vegetation Types

ELC Type	Community Description
Meadow (ME)	
ME Meadow	The ME meadow community was part of a complex of meadow and thicket south of Hwy. 407, on the west side of Bramalea Road.
MEGM3 Dry-Fresh Graminoid Meadow	The MEGM3 meadow communities occurred at the south end of the Project Study Area near the railroad tracks and Hwy. 407. Meadow species were dominated by grasses.
MEMM3 Dry-Fresh Mixed Meadow	The MEMM3 meadow communities occurred at the south end of the Project Study Area near the railroad tracks and Hwy. 407. Meadow species were dominated by herbaceous plant species.
Thicket (TH)	
THD Deciduous Thicket	The THD deciduous thicket community was located in the eastbound Hwy. 407 ramp, and was part of a complex of meadow and thicket south of Hwy. 407, on the west side of Bramalea Road.
Open Water (OA)	
OA Open Water	The OA community consisted of a stormwater management pond in the Go-Station parking lot.
Agricultural (OAG)	
OAGM1 Annual Row Crops	The OAGM1 communities occurred at the south end of the Project Study Area on both sides of Bramalea Road.
Constructed	
CGL_2 Parkland	The CGL_2 parkland communities occurred in the north end of the Project Study Area and consisted of manicured lawn with occasional planted trees. Recreational trails occurred throughout these features.
CGL_4 Recreational	The CGL_4 recreational community was at the north end of the Project Study Area, and consisted of manicured lawn adjacent to a football stadium.
CVC_1 Business Sector	The CVC_1 business communities were scattered throughout the Project Study Area.
CVC_2 Light Industry	The CVC_2 industrial communities were located at the south end of the Project Study Area.
CVI_1 Transportation	The CVI_1 transportation communities represented roadways throughout the Project Study Area, and the Go-Train Station immediately north of the railroad tracks.
CVI_4 Power Generation	The CVI_4 power generation community consisted of an electrical transformer station.
CVR Residential	The CVR communities consisted of residential properties.

Reference: Natural Environmental Assessment for the Bramalea Road Schedule “C” Class Environmental Assessment

Table 2: Ecological Land Classification Vegetation Types

ELC Type	Community Description
CVR_2 High Density Residential	The CVR_2 communities consisted of high-rise apartment buildings and townhouse complexes.
CVR_3 Single Family Residential	The CVR_3 communities consisted of residential subdivisions with single family homes.
CVS_1 Education	The CVS_1 community represented a school on the west side of Bramalea Road.
Lawn	Manicured lawn was associated with the above constructed communities.

TREE INVENTORY AND BAT ROOST ASSESSMENT

All trees in the road right-of-way were assessed during a detailed tree inventory on November 21, 22 and 27, 2018 by a certified arborist. Tree details recorded included tree species, diameter at breast height (DBH), dripline radius, and an assessment of general tree health. A summary table of the tree inventory is included as **Appendix A**. There were no species at risk or provincially rare trees recorded in the right-of-way.

All trees in the right-of-way were also assessed for suitability for bat roosts. The bat roost survey protocol followed the methods in the Bat and Bat Habitat Surveys of Treed Habitats document (MNRF 2017). In accordance with the protocol, live or dead trees that were > 10 cm diameter at breast height (DBH) were considered to be suitable maternity roost trees if they contained cracks, crevices, hollows and/or loose bark. There were no suitable bat roost trees observed in the right-of-way during the tree inventory.

SIGNIFICANT WILDLIFE HABITAT ASSESSMENT

A candidate significant wildlife habitat (SWH) assessment of the Project Area was conducted using guidance provided in the SWH Criteria Schedules for Ecoregion 7E (MNRF 2015). The SWH Criteria Schedules include four (4) general types of significant wildlife habitat: seasonal concentration areas, rare or specialized habitat, habitat for species of conservation concern, and wildlife movement corridors. A summary table of the SWH assessment is provided below in **Table 3**.

Table 3: Significant Wildlife Habitat Assessment

Habitat Type (MNRF 2015)	Habitat Description	Assessment of Candidate SWH
Seasonal Concentration Areas		
Bat hibernacula	Abandoned mine shafts, underground foundations, caves, and crevices	No habitat features that could support bat hibernacula were identified.
Deer wintering congregation areas and deer yards	Deer yards are mapped by MNRF	No deer yards are mapped by MNRF in the Project Area (MNRF 2018).

Reference: Natural Environmental Assessment for the Bramalea Road Schedule “C” Class Environmental Assessment

Table 3: Significant Wildlife Habitat Assessment

Habitat Type (MNRF 2015)	Habitat Description	Assessment of Candidate SWH
Colonially – nesting bird breeding habitat (bank and cliff)	Eroding banks, sandy hills, steep slopes, rock faces or piles. Cliff faces. Does not include disturbed soil areas such as berms, embankments, oil or aggregate stockpiles.	There are no eroding banks present in the Project Area. No suitable habitat meeting the criteria for candidate SWH was identified.
Colonially – nesting bird breeding habitat (trees/shrubs)	Dead trees in large marshes and lakes, flooded timber, and shrubs, with nests of Great Blue Heron, Great Egret, Green Heron, or Black-crowned Night-Heron	No suitable habitat was observed in the Project Area and no stick nests were encountered.
Colonially – nesting bird breeding habitat (ground)	Rock islands and peninsulas in a lake or large river	No suitable habitat was observed in the Project Area.
Waterfowl stopover and staging areas	Fields with evidence of annual spring flooding from meltwater or runoff; aquatic habitats such as ponds, marshes, lakes, bays, and watercourses used during migration, including large marshy wetlands	No suitable habitat was observed in the Project Area.
Shorebird migratory stopover area	Muddy and unvegetated shorelines, beach areas, bars	No suitable habitat was observed in the Project Area.
Raptor wintering areas	Combination of fields and woodland (>20 ha)	None identified. The Project Area does not contain the combination of candidate habitat types to support SWH for raptor wintering areas.
Bat maternity colonies	Mixed and deciduous forests and swamps with large diameter dead or dying trees with cavities	There were no suitable bat maternity colony trees identified during the tree inventory.
Reptile hibernacula	Rock piles or slopes, stone fences, crumbling foundations	No suitable habitat was observed in the Project Area.
Turtle wintering area	Permanent waterbodies and large wetlands with sufficient dissolved oxygen; man-made ponds are not considered SWH.	There were no suitable aquatic areas for turtle wintering areas identified in the Project Area.
Migratory butterfly stopover area	Fields and forests that are a minimum of 10 ha and are located within 5km of Lake Erie or Lake Ontario	Not applicable; Project Area is > 5 km from Lake Erie and Lake Ontario.
Landbird migratory stopover area	Woodlands of a minimum size located within 5km of Lake Erie or Lake Ontario	Not applicable; Project Area is > 5 km from Lake Erie and Lake Ontario.
Rare Vegetation Communities		
Sand barren, alvar, cliffs and talus slopes	Sand barren, Alvar, Cliff and Talus ELC Community Classes, and other areas of exposed bed rock and patchy soil development, near vertical exposed bedrock and slopes of rock rubble	None identified.

Reference: Natural Environmental Assessment for the Bramalea Road Schedule “C” Class Environmental Assessment

Table 3: Significant Wildlife Habitat Assessment

Habitat Type (MNRF 2015)	Habitat Description	Assessment of Candidate SWH
Prairie and savannah	Open canopy habitats (tree cover < 60%) dominated by prairie species	None identified.
Old growth forest	Relatively undisturbed, structurally complex; dominant trees > 100 years' old	None identified.
Other rare vegetation communities	Vegetation communities ranked S1-S3 by the NHIC.	None identified.
Specialized Habitat for Wildlife		
Waterfowl nesting areas	Upland habitats adjacent to wetlands	No suitable habitat was observed in the Project Area.
Bald Eagle and Osprey nesting, foraging and perching habitat	Treed communities adjacent to rivers, lakes, ponds, and other wetlands with stick nests of Bald Eagle or Osprey	No suitable habitat was observed in the Project Area.
Woodland raptor nesting habitat	Stick nests in forested ELC communities >30 ha with 10 ha of interior habitat	No suitable habitat was observed in the Project Area.
Turtle nesting areas	Exposed soil, including sand and gravel in open sunny areas in proximity to wetlands	No suitable habitat was observed in the Project Area.
Seeps and springs	Any forested area with groundwater at surface within the headwaters of a stream or river system	None identified.
Amphibian breeding habitat (woodland and wetland)	Treed uplands with vernal pools, and wetland ecosites	No suitable habitat was observed in the Project Area.
Woodland area sensitive breeding bird habitat	Large mature forest stands, woodlots >30ha with interior forest habitat (i.e. at least 200m from edge)	No suitable habitat was observed in the Project Area.
Habitat for Species of Conservation Concern		
Open country bird breeding habitat	Large grasslands and fields (>30ha) with two or more of the following species; Upland Sandpiper, Grasshopper Sparrow, Vesper Sparrow, Northern Harrier, Savannah Sparrow OR with nesting Short-eared Owls	There was no meadow habitat > 30 ha in size in the Project Area to support open country breeding birds.
Shrub/early successional bird breeding habitat	Large shrub and thicket habitats (>10ha) with; -At least one Brown Thrasher or Clay-colored Sparrow breeding, OR -At least two of Field Sparrow, Black-billed Cuckoo, Eastern Towhee and Willow Flycatcher OR	None identified. The Project Area does not contain the candidate habitat types >10 ha to support SWH for shrub/early successional breeding birds.

Reference: Natural Environmental Assessment for the Bramalea Road Schedule “C” Class Environmental Assessment

Table 3: Significant Wildlife Habitat Assessment

Habitat Type (MNR 2015)	Habitat Description	Assessment of Candidate SWH
	-nesting Yellow-breasted Chat or Golden-winged Warbler.	
Marsh bird breeding habitat	Wetlands with shallow water with emergent aquatic vegetation with American Bittern, Virginia Rail, Sora, Common Moorhen, American Coot, Pied-billed Grebe, Marsh Wren, Sedge Wren, Common Loon, Sandhill Crane, Green Heron, Trumpeter Swan, Black Tern, Yellow Rail	The Project Area does not contain the candidate habitat types to support SWH for marsh breeding birds.
Terrestrial Crayfish	Wet meadows and edges of shallow marshes with burrows or chimneys	The Project Area does not contain the candidate habitat types to support SWH for terrestrial crayfish.
Special Concern and provincially rare (S1-S3) wildlife	An assessment of habitat for special concern and provincially rare wildlife is included in the section above.	Potential suitable habitat for Common Nighthawk was identified in the meadow communities in the Project Area.
Animal Movement Corridors		
Amphibian movement corridors	Associated with confirmed amphibian breeding habitat	No natural amphibian habitat was identified in the Project Area and, therefore, there are no candidate habitat for amphibian movement corridors.

SPECIES AT RISK HABITAT ASSESSMENT

This SAR habitat assessment is based on the results of the background information review (**Table 1**) and the Terrestrial Habitat Assessment.

Amphibians

The Ontario Reptile and Amphibian Atlas (Ontario Nature 2018) identified Western Chorus Frog from the 10km x 10km square that overlaps with the Project Area. Western Chorus frog is a federally threatened species with no provincial designation. There were no aquatic features in the Project Area suitable for amphibian breeding.

Reptiles

There are recent NHIC records for Snapping Turtle from the 1km x 1km square that overlaps with the Project Area. Snapping Turtle is a provincial and federal special concern species. There were no aquatic features in the Project Area suitable for Snapping Turtle.

Reference: Natural Environmental Assessment for the Bramalea Road Schedule “C” Class Environmental Assessment

Birds

The Ontario Breeding Bird Atlas (Cadman et. al. 2007) identified seven (7) bird species from the 10km x 10km square that overlaps with the Project Area: four provincially and federally threatened species (Bank Swallow, Barn Swallow, Chimney Swift and Eastern Meadowlark) and three provincial special concern species (Common Nighthawk, Eastern Wood-Pewee and Wood Thrush).

No suitable eroding banks were present in the Project Area to support Bank Swallow. The Project Area lacked potential nesting structures for Barn Swallow, and suitable chimney structures or hollow trees Chimney Swift. Eastern Wood-Pewee and Wood Thrush are forest species that require mature forest stands for nesting. No suitable forest habitat for these species was present in the Project Area.

Common Nighthawk and Eastern Meadowlark are grassland species. Potential suitable habitat was present for these species in the Project Area within the cultural meadow communities.

Mammals

The Species at Risk in Ontario Website (MNRF 2018b) identified habitat ranges for four (4) endangered bat species that overlap with the Project Area: Eastern Small-footed Myotis, Little Brown Myotis, Northern Myotis and Tri-coloured Bat. There were no suitable cavity trees present in the Project Area to support breeding habitat for these species.

Invertebrates

The Project Area is within the range of Monarch in Southern Ontario (MNRF 2018b). **Potentially suitable foraging habitat for Monarch was present in the meadow communities in the Project Area.**

Species range maps on the Species at Risk in Ontario website (MNRF 2018b) identified occurrences of Rusty-patched Bumblebee close to the Project Area (Mississauga). **Cultural meadow communities provide potential suitable foraging habitat for Rusty-patched Bumblebee.**

Plant Species

The Project Area is within the range of Butternut in Southern Ontario. Butternut is a provincially and federally endangered species. This species was not observed in the Project Area during the tree inventory.

POTENTIAL IMPACTS

Meadow habitat in the southern section of the Project Area has the potential to provide habitat for Common Nighthawk, Eastern Meadowlark, Monarch and Rusty-patched Bumblebee; however, construction activities are limited to the road-right-of-way, and no impacts to the habitat are anticipated.

MITIGATION RECOMMENDATIONS

Tree and vegetation clearing should occur outside of the breeding bird window (i.e. April 1 to August 31) in accordance with the policies of the Migratory Birds Convention Act.

Reference: Natural Environmental Assessment for the Bramalea Road Schedule “C” Class Environmental Assessment

Accidental encroachment by heavy machinery may damage the root zone, limbs or trunks of edge species or disturb/destabilize natural vegetation. Construction fencing is recommended adjacent to the naturalized meadow and thicket communities to clearly delineate the work area and protect vegetation.

STANTEC CONSULTING LTD.



Janice Ball, B.Sc.
Terrestrial Ecologist
Phone: (519) 585-7287
Janice.Ball@stantec.com

Attachment A: Figures 1.1-1.7 – Ecological Land Classification
Attachment B: Detailed Tree Inventory

c. Paula Burnard, Stantec Consulting Ltd.

References

- Cadman, M.D., D.A. Sutherland, G.G. Beck, D. Lepage, A.R. Couturier. 2007. Atlas of the Breeding Birds of Ontario, 2001-2005. (eds) Bird Studies Canada, Environment Canada, Ontario Field Ornithologists, Ontario Ministry of natural resources, and Ontario Nature, Toronto, xxii +706pp. Data available online: <http://www.birdsontario.org/atlas/squareinfo.jsp?lang=en>
- Dobbyn, J. 1994. Atlas of the mammals of Ontario. Don Mills, Ontario. Federation of Ontario Field Naturalists.
- Lee, H.T., W.D. Bakowsky, J. Riley, J. Bowles, M. Puddister, P. Uhlig and S. McMurray. 1998. Ecological land classification for Southern Ontario: first approximation and its application. Ontario Ministry of Natural Resources, South Central Region, Science Development and Transfer Branch. Technical Manual ELC-005.
- [MNRF] Ontario Ministry of Natural Resources and Forestry. 2018a. Natural Heritage Information Centre Data on the MNRF Make A Map: Natural Heritage Areas webpage powered by Land Information Ontario. Available Online: http://www.gisapplication.lrc.gov.on.ca/mamnh/Index.html?site=MNR_NHLUPS_NaturalHeritage&viewer=NaturalHeritage&locale=en-US
- [MNRF] Ontario Ministry of Natural Resources and Forestry. 2018b. Species at Risk in Ontario List. Available Online: <https://www.ontario.ca/page/species-risk-ontario>
- [MNRF] Ontario Ministry of Natural Resources and Forestry. 2017. Survey Protocol for Species at Risk Bats within Treed Habitats. MNRF Guelph District. April 2017.
- [MNRF] Ontario Ministry of Natural Resources and Forestry. 2015b. Significant Wildlife Habitat Criteria Schedules for Ecoregion 7E. January, 2015. Ontario Ministry of Natural Resources and Forestry Regional Operations Division, Peterborough, Ontario. 40 pp.
- Ontario Nature. 2018. Reptiles and Amphibians of Ontario. Ontario Reptile and Amphibian Atlas. Available Online: <https://ontarionature.org/oraa/maps/>

ATTACHMENT A:

Figures 1.1-1.7 – Ecological Land Classification

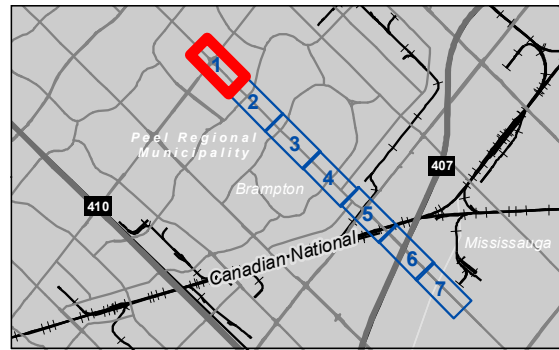

Notes
 1. Coordinate System: NAD 1983 UTM Zone 17N
 2. Base features produced under license with the Ontario Ministry of Natural Resources and Forestry © Queen's Printer for Ontario, 2018.
 3. Orthoimagery © First Base Solutions, 2018. Imagery Date, 2017.

- Legend**
- Bramalea Road Segment
 - Ecological Land Classification
 - 120 m Buffer from Bramalea Rd Centerline
 - Municipal Boundary, Lower
 - Contour (10 m Interval)
 - Contour (5 m Interval)
 - Major Road
 - Minor Road

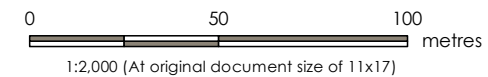

Project Location: 165010590 REVA
 City of Brampton
 Prepared by AMW on 2018-12-19
 Technical Review by JB on 2018-12-18

Client/Project:
 CITY OF BRAMPTON
 BRAMALEA ROAD CLASS EA

Figure No.

1-1

Title

Ecological Land Classification

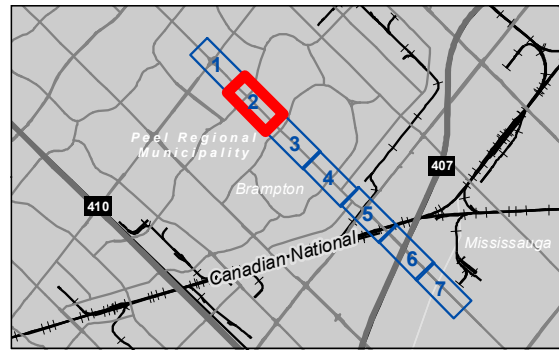
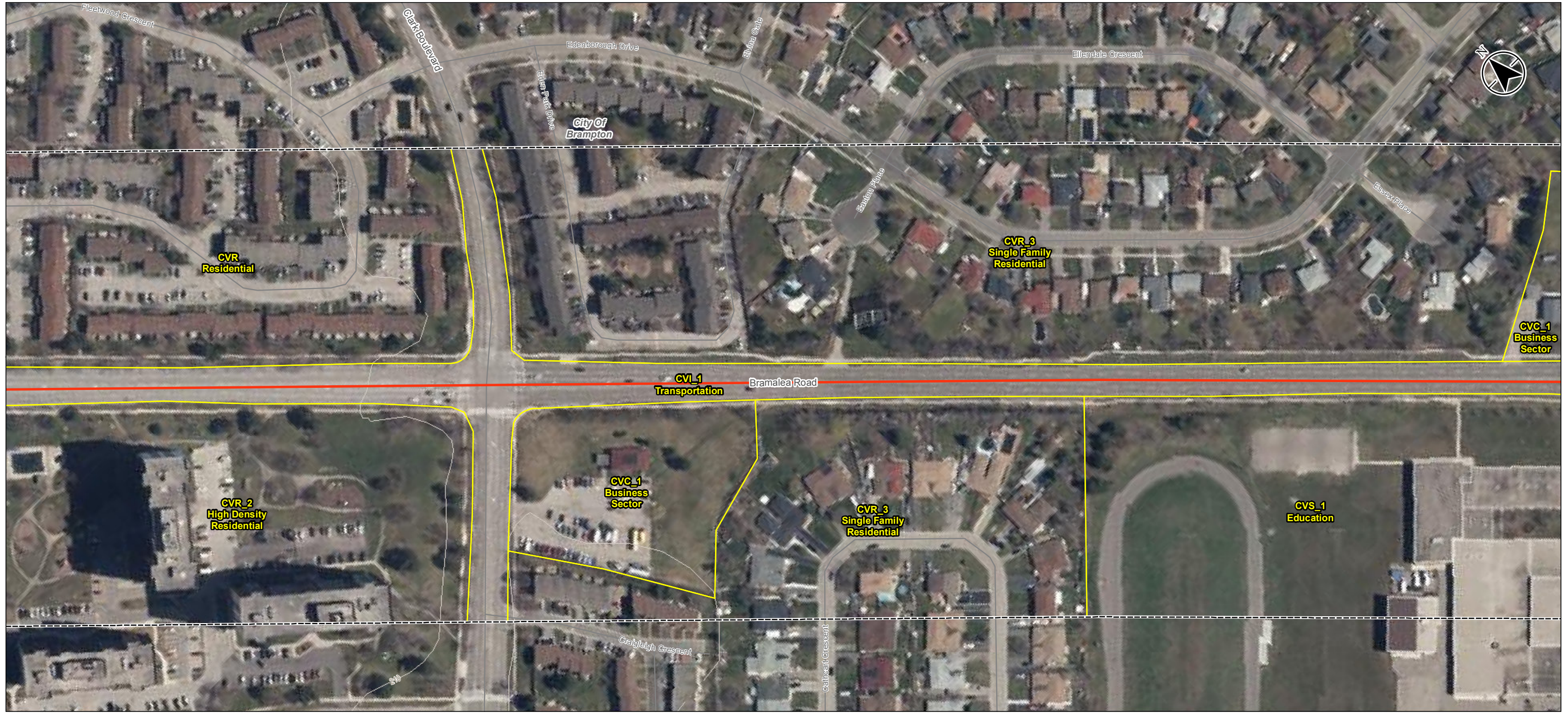

- Notes**
1. Coordinate System: NAD 1983 UTM Zone 17N
 2. Base features produced under license with the Ontario Ministry of Natural Resources and Forestry © Queen's Printer for Ontario, 2018.
 3. Orthoimagery © First Base Solutions, 2018. Imagery Date, 2017.

- Legend**
- Bramalea Road Segment
 - Ecological Land Classification
 - 120 m Buffer from Bramalea Rd Centerline
 - Municipal Boundary, Lower
 - Contour (5 m Interval)
 - Major Road
 - Minor Road

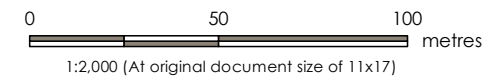

Project Location: 165010590 REVA
 City of Brampton
 Prepared by AMW on 2018-12-19
 Technical Review by JB on 2018-12-18

Client/Project: CITY OF BRAMPTON
 BRAMALEA ROAD CLASS EA

Figure No.

1-2

Title

Ecological Land Classification

C:\proj\2018\102\01\609\active\Other_PCL\Active_V50 - Hamilton\165010590\18_GS\MXD\Ecosystems\Report\Figures\165010590_EAS_Fig01_ETC_RevA.mxd Revised: 2018-12-19 By: gwhite

Disclaimer: Stantec assumes no responsibility for data supplied in electronic format. The recipient accepts full responsibility for verifying the accuracy and completeness of the data. The recipient releases Stantec, its officers, employees, consultants and agents, from any and all claims arising in any way from the content or provision of the data.

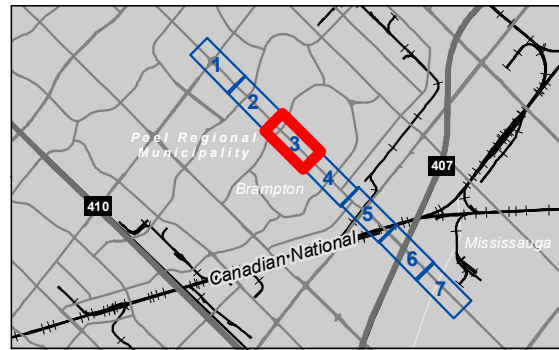
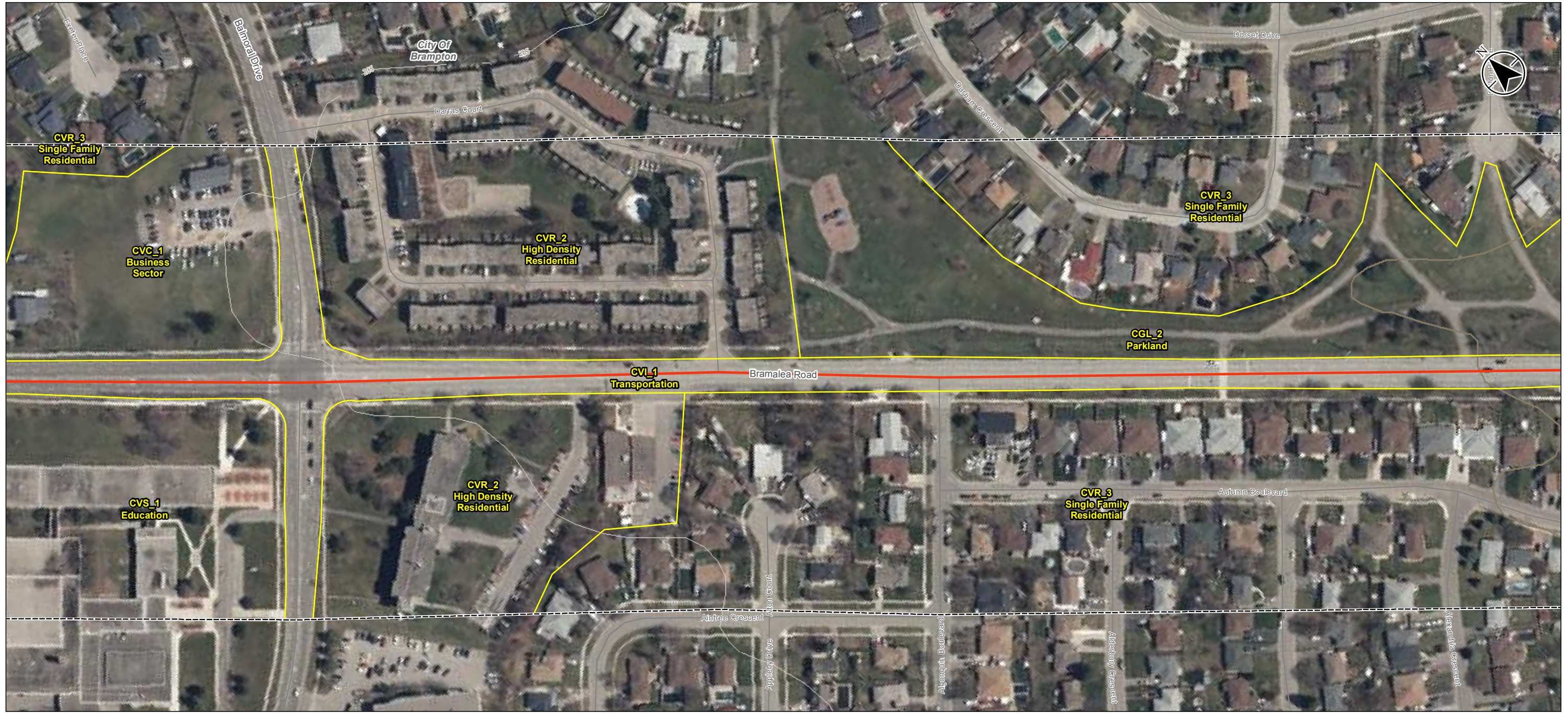

Notes
 1. Coordinate System: NAD 1983 UTM Zone 17N
 2. Base features produced under license with the Ontario Ministry of Natural Resources and Forestry © Queen's Printer for Ontario, 2018.
 3. Orthoimagery © First Base Solutions, 2018. Imagery Date, 2017.

- Legend**
- Bramalea Road Segment
 - Ecological Land Classification
 - 120 m Buffer from Bramalea Rd Centerline
 - Municipal Boundary, Lower
 - Contour (100 m Interval)
 - Contour (10 m Interval)
 - Contour (5 m Interval)
 - Major Road
 - Minor Road



Project Location: 165010590 REVA
 City of Brampton
 Prepared by AMW on 2018-12-19
 Technical Review by JB on 2018-12-18

Client/Project:
 CITY OF BRAMPTON
 BRAMALEA ROAD CLASS EA

Figure No.

1-3

Title

Ecological Land Classification

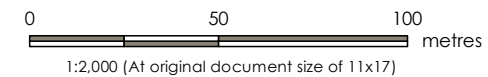

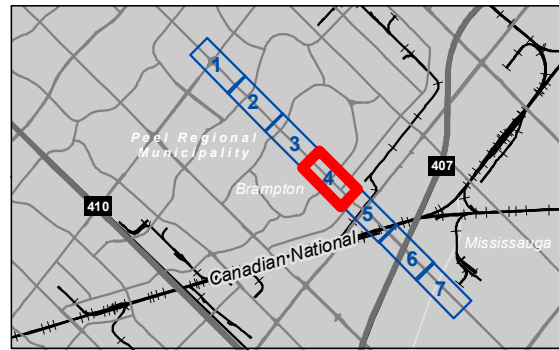
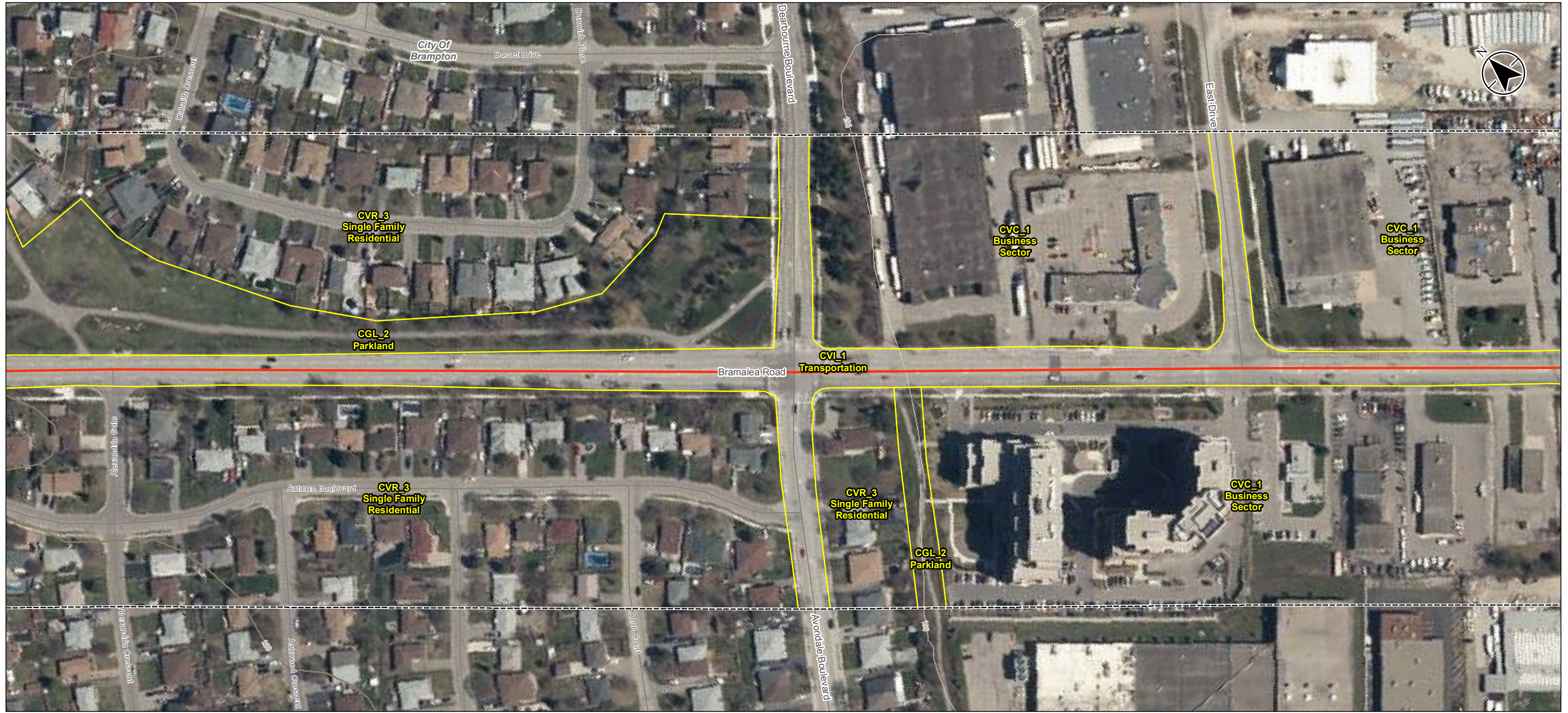

- Notes**
1. Coordinate System: NAD 1983 UTM Zone 17N
 2. Base features produced under license with the Ontario Ministry of Natural Resources and Forestry © Queen's Printer for Ontario, 2018.
 3. Orthoimagery © First Base Solutions, 2018. Imagery Date, 2017.

- Legend**
- Bramalea Road Segment
 - Ecological Land Classification
 - 120 m Buffer from Bramalea Rd Centerline
 - Municipal Boundary, Lower
 - Contour (100 m Interval)
 - Contour (10 m Interval)
 - Contour (5 m Interval)
 - Major Road
 - Minor Road

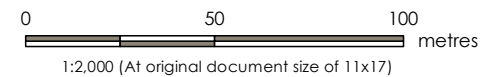

Project Location: 165010590 REVA
 City of Brampton
 Prepared by AMW on 2018-12-19
 Technical Review by JB on 2018-12-18

Client/Project:
 CITY OF BRAMPTON
 BRAMALEA ROAD CLASS EA

Figure No.

1-4

Title

Ecological Land Classification

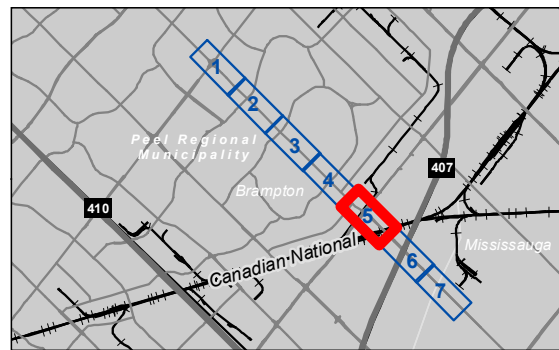
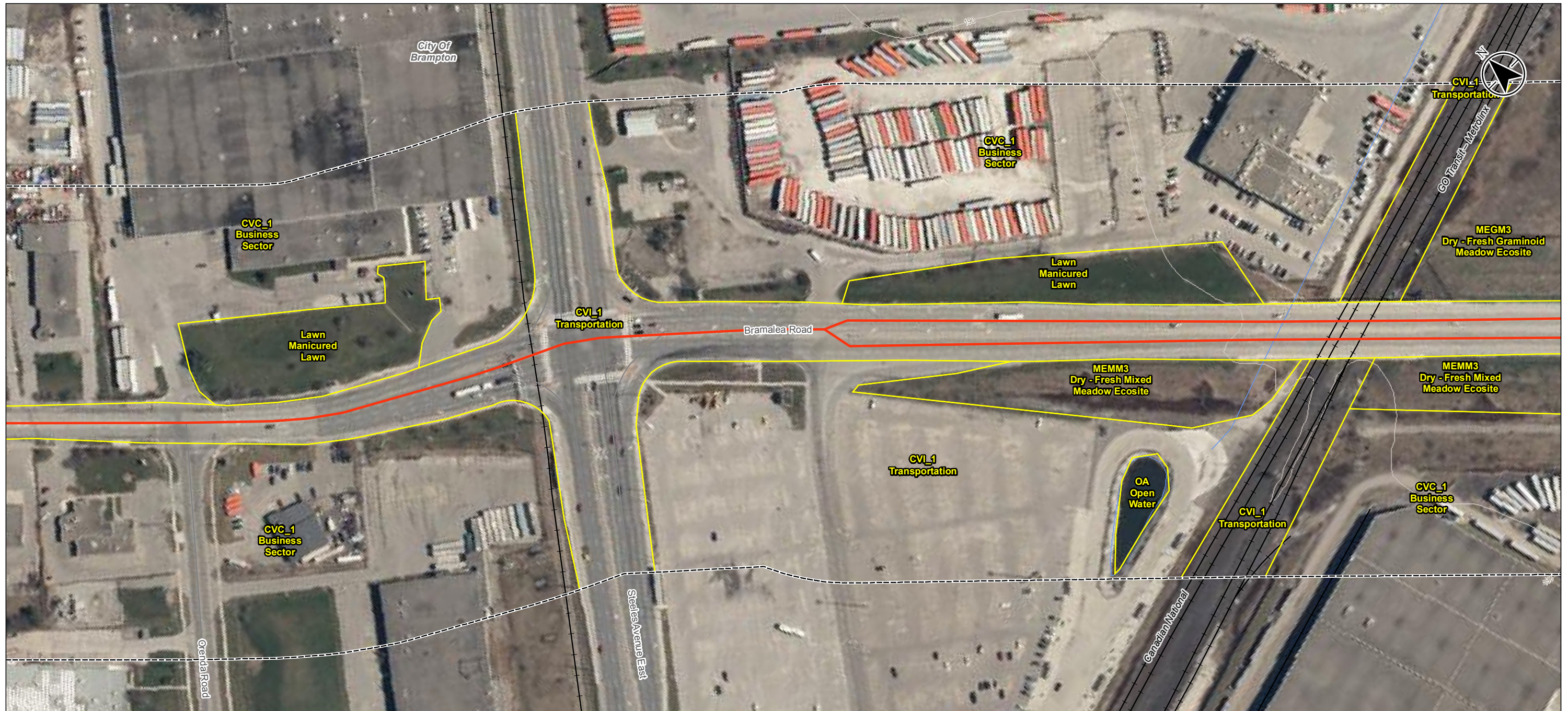

- Notes**
1. Coordinate System: NAD 1983 UTM Zone 17N
 2. Base features produced under license with the Ontario Ministry of Natural Resources and Forestry © Queen's Printer for Ontario, 2018.
 3. Orthoimagery © First Base Solutions, 2018. Imagery Date, 2017.

- Legend**
- Bramalea Road Segment
 - Ecological Land Classification
 - 120 m Buffer from Bramalea Rd Centerline
 - Municipal Boundary, Lower
 - Contour (5 m Interval)
 - Major Road
 - Railway
 - Watercourse (Permanent)
 - Waterbody

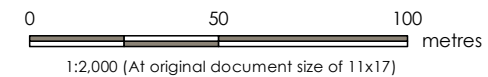

Project Location: 165010590 REVA
 City of Brampton
 Prepared by AMW on 2018-12-19
 Technical Review by JB on 2018-12-18

Client/Project:
 CITY OF BRAMPTON
 BRAMALEA ROAD CLASS EA

Figure No.

1-5

Title

Ecological Land Classification

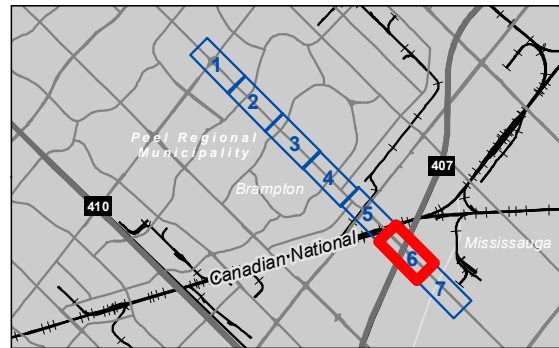
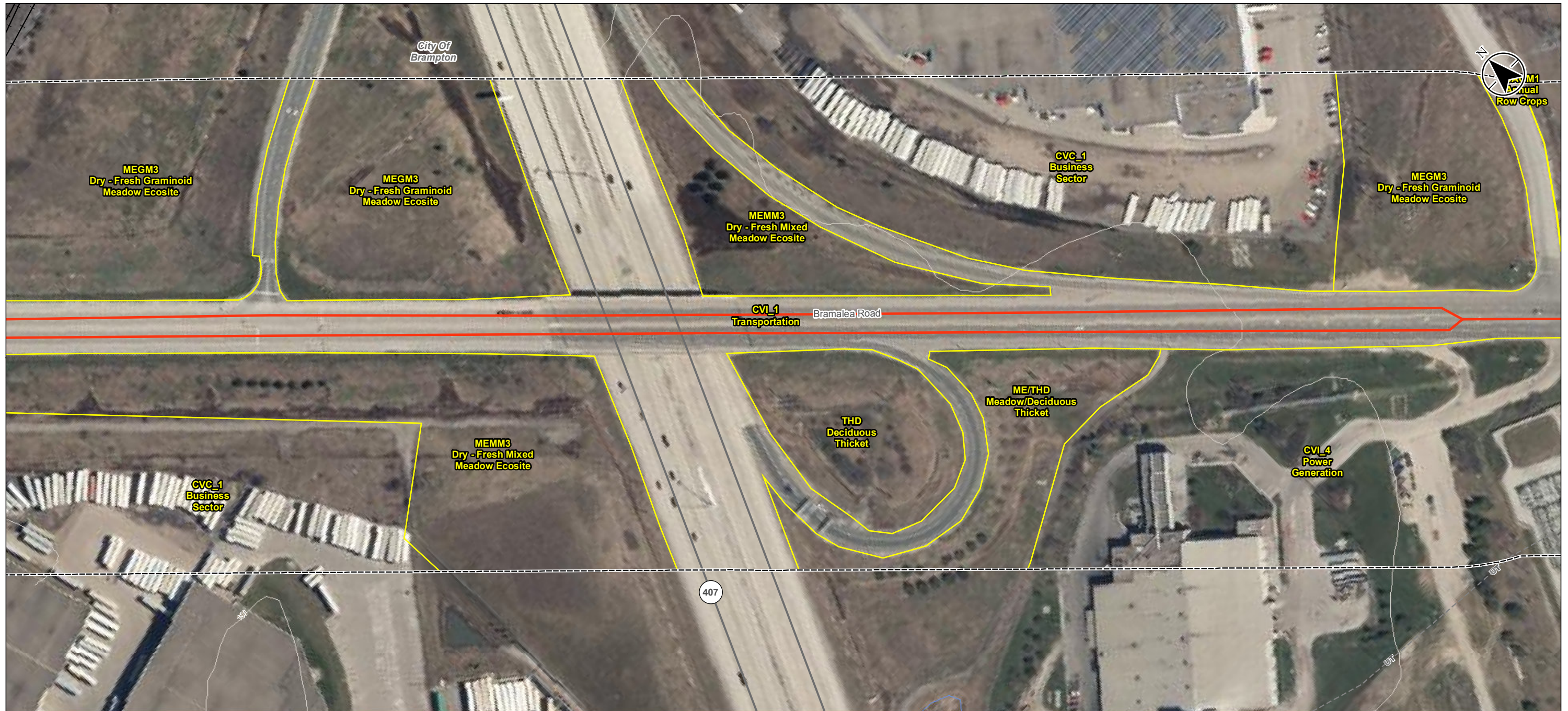

Notes
 1. Coordinate System: NAD 1983 UTM Zone 17N
 2. Base features produced under license with the Ontario Ministry of Natural Resources and Forestry © Queen's Printer for Ontario, 2018.
 3. Orthoimagery © First Base Solutions, 2018. Imagery Date, 2017.

- Legend**
- Bramalea Road Segment
 - Ecological Land Classification
 - 120 m Buffer from Bramalea Rd Centerline
 - Municipal Boundary, Lower
 - Contour (5 m Interval)
 - Highway
 - Major Road
 - Railway
 - Hydro Line
 - UT-- Unknown Transmission Line
 - Waterbody

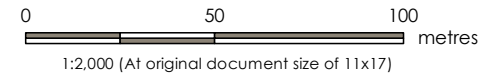

Project Location: City of Brampton
 Prepared by AMW on 2018-12-19
 Technical Review by JB on 2018-12-18

Client/Project: CITY OF BRAMPTON
 BRAMALEA ROAD CLASS EA

Figure No.

1-6

Title

Ecological Land Classification

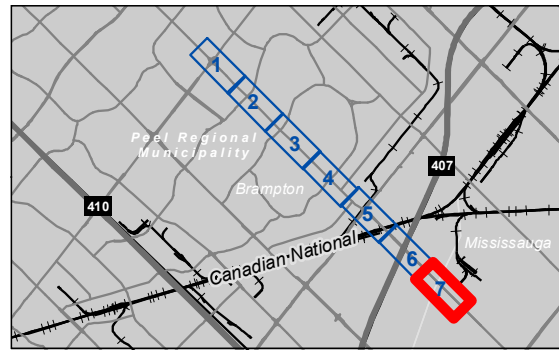
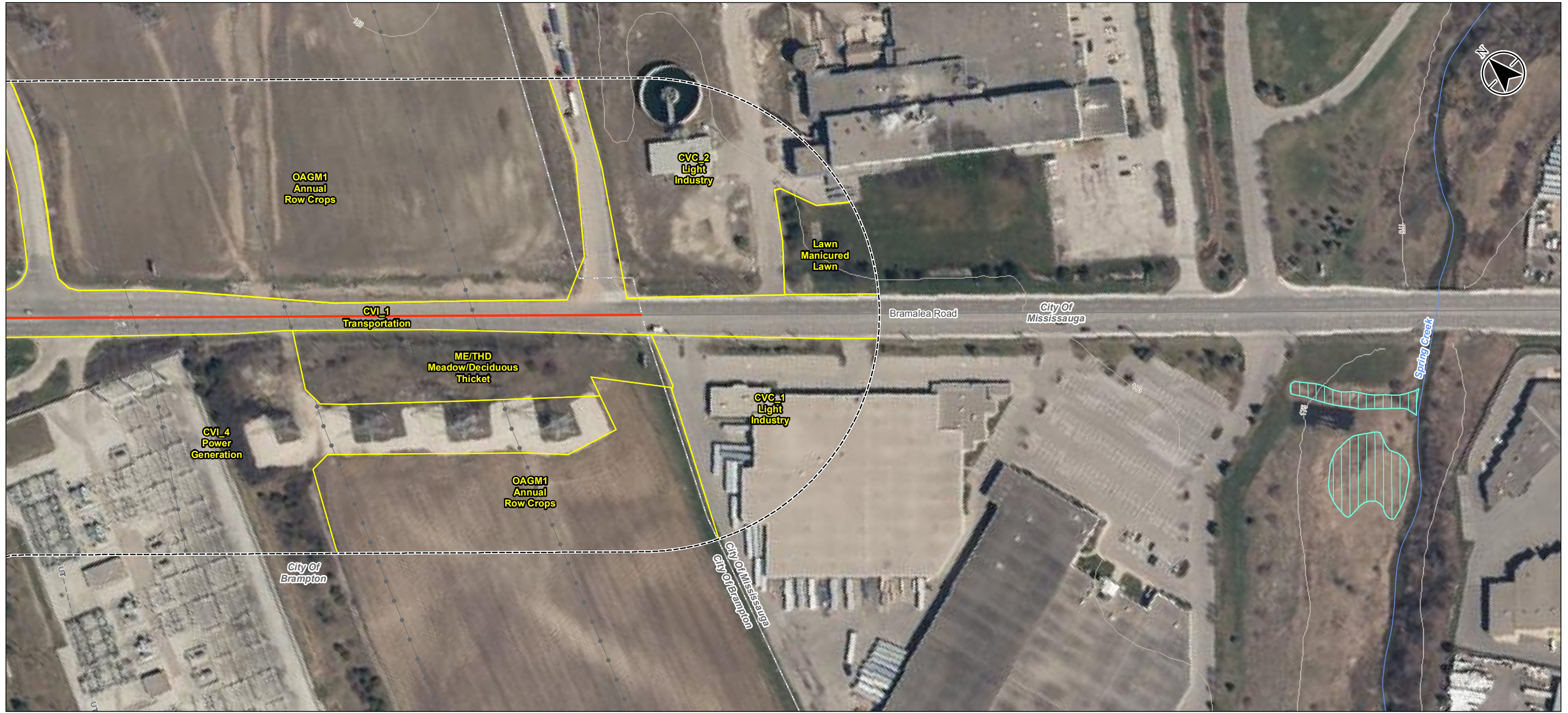

- Notes**
1. Coordinate System: NAD 1983 UTM Zone 17N
 2. Base features produced under license with the Ontario Ministry of Natural Resources and Forestry © Queen's Printer for Ontario, 2018.
 3. Orthoimagery © First Base Solutions, 2018. Imagery Date, 2017.

- Legend**
- Bramalea Road Segment
 - Ecological Land Classification
 - 120 m Buffer from Bramalea Rd Centerline
 - Municipal Boundary, Lower
 - Contour (10 m Interval)
 - Contour (5 m Interval)
 - Major Road
 - Hydro Line
 - - - Unknown Transmission Line
 - Watercourse (Permanent)
 - Wetland, Not evaluated per OWES

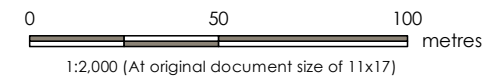

Project Location: City of Brampton
 Prepared by AMW on 2018-12-19
 Technical Review by JB on 2018-12-18

Client/Project: CITY OF BRAMPTON
 BRAMALEA ROAD CLASS EA

Figure No.

1-7

Title

Ecological Land Classification

C:\proj\2020\02\01\609\active\EA - Hamilton\165010590\18_GS\MXD\Ecosystems\Report\Figures\165010590_EAS_Fig01_ELC_RevA.mxd Revised: 2018-12-19 By: gwh/le

Disclaimer: Stantec assumes no responsibility for data supplied in electronic format. The recipient accepts full responsibility for verifying the accuracy and completeness of the data. The recipient releases Stantec, its officers, employees, consultants and agents, from any and all claims arising in any way from the content or provision of the data.

ATTACHMENT B:
Detailed Tree Inventory

TABLE 1. Detailed Tree Inventory, Bramalea Road Environmental Assessment, Brampton Ontario
Data collected: November 21st; November 22nd; November 27th, 2018

Tag #	Botanical Name	Common Name	DBH (cm)					Dripline Radius (m)	Condition				Comments	Required Tree Protection Zone (m)
			Stem 1	Stem 2	Stem 3	Stem 4	Stem 5		Trunk Integrity	Crown Structure	Crown Vigour	Overall Condition		
1	<i>Quercus robur</i> 'Fastigiata'	columnar english oak	30					4	Poor	Poor	Fair	Poor	Topped at 4 m	4
2	<i>Quercus robur</i>	english oak	27	12	8	8	8	3	Good	Good	Good	Good		3
3	<i>Quercus robur</i> 'Fastigiata'	columnar english oak	16	11	10	8	8	3	Good	Good	Good	Good		3
4	<i>Quercus robur</i> 'Fastigiata'	columnar english oak	22	20	10	8	8	3	Good	Good	Good	Good		3
5	<i>Syringa vulgaris</i>	common lilac	8					1	Good	Good	Good	Good		1
6	<i>Acer x freemanii</i>	Freeman maple	9					1	Fair	Fair	Fair	Fair		1
7	<i>Acer x freemanii</i>	Freeman maple	9					1	Good	Good	Good	Good		1
8	<i>Acer x freemanii</i>	Freeman maple	7					1	Good	Good	Fair	Good		1
9	<i>Acer x freemanii</i>	Freeman maple	7					1	Fair	Fair	Fair	Good	Leader dead	1
10	<i>Acer x freemanii</i>	Freeman maple	7					1	Good	Good	Good	Good		1
11	<i>Acer x freemanii</i>	Freeman maple	9					1	Good	Good	Good	Good		1
12	<i>Acer x freemanii</i>	Freeman maple	7					1	Good	Good	Good	Good	Planted a little high	1
13	<i>Acer x freemanii</i>	Freeman maple	7					1	Good	Good	Good	Good		1
14	<i>Acer x freemanii</i>	Freeman maple	7					1	Good	Good	Good	Good		1
15	<i>Acer x freemanii</i>	Freeman maple	7					1	Good	Good	Good	Good	Planted a little high	1
16	<i>Acer x freemanii</i>	Freeman maple	7					1	Poor	Poor	Poor	Poor	Large trunk wound, leader dead	1
17	<i>Quercus rubra</i>	red oak	40					4.5	Good	Good	Fair	Good		9
18	<i>Pinus nigra</i>	Austrian pine	37					5	Good	Good	Good	Good		10
19	<i>Amelanchier</i> sp.	service berry	15	15	15	11		3.5	Good	Good	Good	Good		3.5
20	<i>Syringa vulgaris</i>	common lilac	14	13	12	10	8	3	Good	Good	Good	Good		3
21	<i>Syringa vulgaris</i>	common lilac	14	11	10	8	8	3	Good	Good	Good	Good		3
22	<i>Pinus nigra</i>	Austrian pine	36					3	Good	Fair	Good	Good	Low branch with sweep	6
23	<i>Pinus nigra</i>	Austrian pine	51					5	Fair	Good	Good	Good	Codominant trunks 2 m up	10
24	<i>Gleditsia triacanthos</i>	honey-locust	35					5	Good	Good	Good	Good		10
25	<i>Gleditsia triacanthos</i>	honey-locust	35					5	Good	Good	Good	Good		10
26	<i>Gleditsia triacanthos</i>	honey-locust	47					5	Good	Fair	Good	Good	Pruned for lines	10
27	<i>Gleditsia triacanthos</i>	honey-locust	43					5	Good	Fair	Good	Good	Pruned for lines	10
28	<i>Gleditsia triacanthos</i>	honey-locust	47					5	Good	Fair	Good	Good	Pruned for lines	10
29	<i>Gleditsia triacanthos</i>	honey-locust	47					5	Good	Fair	Good	Good	Pruned for lines	10
30	<i>Gleditsia triacanthos</i>	honey-locust	31					4	Good	Fair	Good	Good	Pruned for lines	8
31	<i>Gleditsia triacanthos</i>	honey-locust	31					4	Good	Fair	Good	Good	Pruned for lines	8
32	<i>Gleditsia triacanthos</i>	honey-locust	47					5	Good	Fair	Good	Good	Pruned for lines	10
33	<i>Gleditsia triacanthos</i>	honey-locust	37					5	Good	Fair	Good	Good	Pruned for lines	10
34	<i>Gleditsia triacanthos</i>	honey-locust	34					4	Good	Fair	Good	Good	Pruned for lines	8
35	<i>Ulmus pumila</i>	Siberian elm	49					3.5	Fair	Poor	Good	Fair	Codominant stems with included bark, pruned for lines	7
36	<i>Ulmus pumila</i>	Siberian elm	49					4	Fair	Fair	Good	Fair	Codominant stems with included bark, pruned for lines	8
37	<i>Acer saccharinum</i>	silver maple	14					2	Poor	Poor	Fair	Poor	Dead codominant	2
38	<i>Ulmus pumila</i>	Siberian elm	53					4	Fair	Fair	Good	Fair	pruned for lines	8
39	<i>Ulmus pumila</i>	Siberian elm	43					4	Fair	Poor	Good	Fair	pruned for lines, poor stem alignment	8
40	<i>Ulmus pumila</i>	Siberian elm	20					2	Fair	Poor	Fair	Poor	poor stem alignment, topped	2
41	<i>Ulmus pumila</i>	Siberian elm	33					4	Fair	Fair	Good	Fair	pruned for lines, waterspouts	8
42	<i>Ulmus pumila</i>	Siberian elm	42					4	Fair	Fair	Good	Fair	pruned for lines, waterspouts, poor trunk alignment	8
43	<i>Ulmus pumila</i>	Siberian elm	28					2	Fair	Poor	Fair	Poor	poor stem alignment	2
44	<i>Ulmus pumila</i>	Siberian elm	33	26				4	Fair	Fair	Good	Fair	pruned for lines, waterspouts, scaffold sweep	8
45	<i>Ulmus pumila</i>	Siberian elm	47					5.5	Fair	Poor	Good	Fair	Pruned for lines, poor stem alignment, poor scaffold taper	11
46	<i>Ulmus pumila</i>	Siberian elm	21					3	Good	Good	Good	Good		3
47	<i>Ulmus pumila</i>	Siberian elm	35					3	Fair	Poor	Good	Fair	Trunk bow	6
48	<i>Ulmus pumila</i>	Siberian elm	35					3	Fair	Poor	Good	Fair	Trunk bow, waterspouts	6
49	<i>Ulmus pumila</i>	Siberian elm	30					3	Poor	Poor	Good	Poor	Trunk bow, waterspouts, topped	3
50	<i>Ulmus pumila</i>	Siberian elm	35					4	Fair	Fair	Good	Fair	Trunk bow, scaffold bow	8
51	<i>Ulmus pumila</i>	Siberian elm	44					4	Good	Fair	Good	Good	Trimmed for lines	8
52	<i>Ulmus pumila</i>	Siberian elm	40					3	Fair	Poor	Good	Fair	Trunk bow	6
53	<i>Ulmus pumila</i>	Siberian elm	15					2	Fair	Fair	Good	Fair	Topped	2
54	<i>Ulmus pumila</i>	Siberian elm	40					4	Good	Fair	Good	Good	Codominant stem removed at base, trunk bow	8
55	<i>Ulmus pumila</i>	Siberian elm	26					4	Fair	Fair	Good	Fair	Waterspouts, trunk bow	4
56	<i>Ulmus pumila</i>	Siberian elm	44					6	Fair	Fair	Good	Fair	Pruned for lines	12
57	<i>Ulmus pumila</i>	Siberian elm	13					2	Fair	Fair	Good	Fair	Pruned for lines	2

TABLE 1. Detailed Tree Inventory, Bramalea Road Environmental Assessment, Brampton Ontario
Data collected: November 21st; November 22nd; November 27th, 2018

Tag #	Botanical Name	Common Name	DBH (cm)					Dripline Radius (m)	Condition				Comments	Required Tree Protection Zone (m)
			Stem 1	Stem 2	Stem 3	Stem 4	Stem 5		Trunk Integrity	Crown Structure	Crown Vigour	Overall Condition		
58	<i>Ulmus pumila</i>	Siberian elm	18					2	Fair	Fair	Good	Fair	Pruned for lines	2
59	<i>Ulmus pumila</i>	Siberian elm	35					6	Fair	Fair	Good	Fair	Pruned for lines, trunk bow	12
61	<i>Ulmus pumila</i>	Siberian elm	10					2	Fair	Fair	Good	Fair	Pruned for lines	2
62	<i>Ulmus pumila</i>	Siberian elm	10					2	Fair	Fair	Good	Fair	Pruned for lines	2
63	<i>Ulmus pumila</i>	Siberian elm	36					5	Fair	Fair	Good	Fair	Pruned for lines, trunk bow	10
64	<i>Ulmus pumila</i>	Siberian elm	30					4	Fair	Poor	Good	Fair	Pruned for lines, trunk bow, codominant removed	4
66	<i>Ulmus pumila</i>	Siberian elm	34					4	Poor	Poor	Good	Poor	Pruned for lines, trunk bow, codominant removed	8
67	<i>Ulmus pumila</i>	Siberian elm	28					4	Fair	Fair	Good	Fair	Pruned for lines, trunk bow, codominant removed	4
68	<i>Ulmus pumila</i>	Siberian elm	48					5	Fair	Poor	Good	Fair	Pruned for lines, significant trunk bow, codominant removed	10
69	<i>Ulmus pumila</i>	Siberian elm	42					5	Fair	Fair	Good	Fair		10
70	<i>Ulmus pumila</i>	Siberian elm	30					4	Poor	Poor	Good	Poor	Pruned for lines, significant trunk bow, codominant removed	4
71	<i>Ulmus pumila</i>	Siberian elm	36					5	Fair	Fair	Good	Fair		10
72	<i>Ulmus pumila</i>	Siberian elm	25	23				5	Fair	Fair	Good	Fair	Pruned for lines, waterspouts	5
73	<i>Ulmus pumila</i>	Siberian elm	30					4	Fair	Fair	Good	Fair	Pruned for lines, waterspouts	4
74	<i>Ulmus pumila</i>	Siberian elm	27					4	Poor	Poor	Good	Poor	Pruned for lines, waterspouts, very poor trunk alignment	4
75	<i>Ulmus pumila</i>	Siberian elm	29					4	Fair	Fair	Good	Fair	Pruned for lines, waterspouts	4
76	<i>Ulmus pumila</i>	Siberian elm	24					4	Fair	Fair	Good	Fair	Pruned for lines, waterspouts, codominant removed	4
77	<i>Ulmus pumila</i>	Siberian elm	35					4	Fair	Fair	Good	Fair	Pruned for lines, waterspouts	8
78	<i>Ulmus pumila</i>	Siberian elm	34					4	Fair	Fair	Good	Fair	Pruned for lines, waterspouts	8
79	<i>Ulmus pumila</i>	Siberian elm	40					5	Good	Fair	Good	Good	Pruned for lines, waterspouts	10
80	<i>Ulmus pumila</i>	Siberian elm	30					4	Poor	Poor	Poor	Poor	Pruned for lines, waterspouts, hazard tree - dead codominant	4
81	<i>Ulmus pumila</i>	Siberian elm	40					5	Poor	Fair	Good	Fair	Pruned for lines, waterspouts, very poor trunk alignment	10
82	<i>Malus sp.</i>	apple sp.	13	10	8			2	Good	Good	Good	Good		2
83	<i>Malus sp.</i>	apple sp.	26					3.5	Good	Good	Good	Good		3.5
84	<i>Malus sp.</i>	apple sp.	24					3.5	Good	Good	Good	Good		3.5
85	<i>Malus sp.</i>	apple sp.	29					3.5	Good	Good	Good	Good		3.5
86	<i>Tilia cordata</i>	little-leaf linden	36					3	Fair	Poor	Fair	Poor	Pollarded	6
87	<i>Malus sp.</i>	apple sp.	20	18	17	17	16	4	Good	Good	Good	Good		4
88	<i>Malus sp.</i>	apple sp.	24	23	22			4	Good	Good	Good	Good		4
89	<i>Malus sp.</i>	apple sp.	24					2	Fair	Fair	Good	Fair	Pruned 1/2 for lines	2
90	<i>Malus sp.</i>	apple sp.	20	18				2	Fair	Fair	Good	Fair	Pruned 1/3 for lines	2
91	<i>Malus sp.</i>	apple sp.	20	16	14	10		4	Good	Good	Good	Good		4
92	<i>Malus sp.</i>	apple sp.	20	19	18			4	Good	Good	Good	Good		4
93	<i>Malus sp.</i>	apple sp.	31					4.5	Good	Good	Fair	Good		9
94	<i>Tilia cordata</i>	little-leaf linden	42					5	Fair	Good	Good	Good	Weak union with included bark	10
95	<i>Tilia cordata</i>	little-leaf linden	37					5	Fair	Good	Good	Good	Weak union with included bark	10
96	<i>Pinus nigra</i>	Austrian pine	53					5.5	Good	Good	Good	Good	Would likely require a pruning permit	11
97	<i>Malus sp.</i>	apple sp.	27					4	Good	Good	Good	Good		4
98	<i>Malus sp.</i>	apple sp.	21					3	Good	Good	Fair	Good		3
99	<i>Malus sp.</i>	apple sp.	30					4	Good	Good	Good	Good		4
100	<i>Tilia cordata</i>	little-leaf linden	30					6	Good	Good	Good	Good	Girdling root	6
101	<i>Malus sp.</i>	apple sp.	17					2	Poor	Poor	Poor	Poor	Swollen root flare, very large trunk wound, codominant removed	2
102	<i>Tilia cordata</i>	little-leaf linden	46					8	Good	Good	Good	Good		16
103	<i>Tilia cordata</i>	little-leaf linden	43					6	Good	Fair	Good	Good	Scaffold failure	12
104	<i>Tilia cordata</i>	little-leaf linden	49					6	Good	Good	Good	Good		12
105	<i>Malus sp.</i>	apple sp.	19					2	Good	Fair	Fair	Fair		2
106	<i>Tilia cordata</i>	little-leaf linden	35					5	Poor	Fair	Good	Fair	Very large trunk wound with deadwood	10
107	<i>Tilia cordata</i>	little-leaf linden	36					5	Fair	Fair	Good	Fair	Large scaffold removed	10
108	<i>Malus sp.</i>	apple sp.	27					3	Fair	Poor	Good	Fair	Codominant removed	3
109	<i>Tilia cordata</i>	little-leaf linden	39					4	Poor	Good	Good	Fair	3.9m trunk crack from base	8
110	<i>Tilia cordata</i>	little-leaf linden	50					6	Good	Good	Good	Good		12
111	<i>Tilia cordata</i>	little-leaf linden	35					4	Good	Fair	Good	Good		8
112	<i>Tilia cordata</i>	little-leaf linden	52					6	Fair	Fair	Good	Good	Multiple attachments	12
113	<i>Malus sp.</i>	apple sp.	18					2	Poor	Poor	Poor	Poor	Large trunk wound, heavy epicormic growth	2

TABLE 1. Detailed Tree Inventory, Bramalea Road Environmental Assessment, Brampton Ontario
Data collected: November 21st; November 22nd; November 27th, 2018

Tag #	Botanical Name	Common Name	DBH (cm)					Dripline Radius (m)	Condition				Comments	Required Tree Protection Zone (m)
			Stem 1	Stem 2	Stem 3	Stem 4	Stem 5		Trunk Integrity	Crown Structure	Crown Vigour	Overall Condition		
114	<i>Tilia cordata</i>	little-leaf linden	43					5	Good	Good	Good	Good	Calloused trunk wound	10
115	<i>Tilia cordata</i>	little-leaf linden	39					4.5	Good	Fair	Good	Good		9
116	<i>Tilia cordata</i>	little-leaf linden	49					6	Good	Fair	Good	Good	Pruned for lines	12
117	<i>Malus sp.</i>	apple sp.	39					4	Good	Good	Good	Good	Pruned for lines	8
118	<i>Malus sp.</i>	apple sp.	18	14				3	Good	Good	Good	Good	Pruned for lines	3
119	<i>Malus sp.</i>	apple sp.	21					3	Good	Good	Good	Good		3
120	<i>Tilia cordata</i>	little-leaf linden	38					6	Good	Fair	Good	Good	Pruned for lines	12
121	<i>Malus sp.</i>	apple sp.	21					3	Fair	Poor	Good	Fair	Scaffold pruned	3
122	<i>Tilia cordata</i>	little-leaf linden	56					5	Poor	Fair	Good	Fair	Pruned for lines, codominant with included bark	10
123	<i>Acer negundo</i>	Manitoba maple	23	21	18			4	Fair	Good	Good	Good		4
124	<i>Tilia cordata</i>	little-leaf linden	53					5	Fair	Fair	Good	Fair	Pruned for lines, multiple attachments	10
125	<i>Acer platanoides</i>	Norway maple	26	22				4	Fair	Good	Good	Good		4
126	<i>Acer platanoides</i>	Norway maple	23	23				4	Fair	Good	Good	Good		4
127	<i>Acer platanoides</i>	Norway maple	38	19				5	Poor	Good	Good	Good	Codominant with included bark	10
128	<i>Tilia cordata</i>	little-leaf linden	41					5	Fair	Poor	Good	Fair	Pruned for lines, multiple attachments	10
129	<i>Tilia cordata</i>	little-leaf linden	45					5	Fair	Poor	Good	Fair	Pruned for lines, multiple attachments	10
130	<i>Tilia cordata</i>	little-leaf linden	40					5	Good	Fair	Good	Good	Pruned for lines, multiple attachments	10
131	<i>Acer saccharinum</i>	silver maple	68					8	Good	Fair	Good	Good		16
132	<i>Gleditsia triacanthos</i>	honey-locust	45					7	Good	Good	Good	Good		14
133	<i>Acer saccharinum</i>	silver maple	40	23				4.5	Poor	Poor	Good	Poor	Poor pruning job - 2 codominants topped and watersprouting	9
134	<i>Tilia cordata</i>	little-leaf linden	29					5	Good	Good	Good	Good		5
135	<i>Tilia cordata</i>	little-leaf linden	32					5	Good	Good	Good	Good		10
136	<i>Tilia cordata</i>	little-leaf linden	29					5	Good	Good	Good	Good		5
137	<i>Tilia cordata</i>	little-leaf linden	24	14	14			5	Fair	Fair	Good	Fair		5
138	<i>Tilia cordata</i>	little-leaf linden	23					4	Poor	Good	Good	Fair	Very large trunk wound with deadwood	4
139	<i>Tilia cordata</i>	little-leaf linden	38					6	Good	Good	Good	Good		12
140	<i>Fraxinus pennsylvanica</i>	green ash	35					4	Poor	Poor	Poor	Poor	EAB	8
141	<i>Tilia cordata</i>	little-leaf linden	23					4	Poor	Good	Good	Fair	1.5 m crack in trunk	4
142	<i>Tilia cordata</i>	little-leaf linden	23					4.5	Good	Good	Good	Good		4.5
143	<i>Tilia cordata</i>	little-leaf linden	26					4.5	Good	Good	Good	Good		4.5
144	<i>Tilia cordata</i>	little-leaf linden	23					4.5	Good	Good	Good	Good		4.5
145	<i>Fraxinus pennsylvanica</i>	green ash	47					4	Poor	Poor	Poor	Poor	EAB, pollarded	8
146	<i>Fraxinus pennsylvanica</i>	green ash	43					4	Poor	Poor	Poor	Poor	EAB, pollarded	8
147	<i>Fraxinus pennsylvanica</i>	green ash	40					4	Poor	Poor	Poor	Poor	EAB, pollarded	8
148	<i>Tilia cordata</i>	little-leaf linden	40					5	Fair	Good	Good	Good	Codominants with included bark	10
149	<i>Acer platanoides</i>	Norway maple	23					4	Poor	Poor	Poor	Poor	Bracket, deadwood	4
150	<i>Acer platanoides</i>	Norway maple	23					4	Good	Good	Fair	Fair		4
151	<i>Acer platanoides</i>	Norway maple	30					5	Good	Good	Good	Good		5
152	<i>Acer platanoides</i>	Norway maple	24					4	Good	Good	Fair	Good		4
153	<i>Gleditsia triacanthos</i>	honey-locust	16					4	Good	Good	Good	Good		4
154	<i>Malus sp.</i>	apple sp.	20	18	16	16	12	3	Good	Good	Good	Good		3
155	<i>Malus sp.</i>	apple sp.	16	15	14	14		3	Good	Good	Good	Good		3
156	<i>Malus sp.</i>	apple sp.	21	15	14	14		3	Good	Good	Good	Good		3
157	<i>Fraxinus pennsylvanica</i>	green ash	26					3.5	Poor	Poor	Poor	Poor	EAB	3.5
501	<i>Acer platanoides</i>	Norway maple	25					4	Good	Good	Good	Good		4
502	<i>Picea pungens</i>	Colorado spruce	18					3	Fair	Good	Good	Fair		3
503	<i>Gleditsia triacanthos</i>	honey-locust	18					3.5	Good	Good	Good	Good		3.5
504	<i>Picea pungens</i>	Colorado spruce	15					2	Good	Good	Good	Good		2
505	<i>Quercus rubra</i>	red oak	18					3	Good	Good	Good	Good		3
506	<i>Quercus rubra</i>	red oak	22					3.5	Good	Good	Good	Good		3.5
506	<i>Malus sp.</i>	apple sp.	26					4.5	Good	Good	Good	Good		4.5
507	<i>Malus sp.</i>	apple sp.	23					0	Good	Good	Good	Good		0
508	<i>Malus sp.</i>	apple sp.	29					4.5	Good	Good	Good	Good		4.5
509	<i>Acer platanoides</i>	Norway maple	14					1	Fair	Poor	Fair	Poor	Fungus on trunk. Suckering branches	1
510	<i>Acer platanoides</i>	Norway maple	12					1.5	Good	Poor	Fair	Poor		1.5
511	<i>Acer platanoides</i>	Norway maple	9					1	Poor	Poor	Poor	Poor		1
512	<i>Gleditsia triacanthos</i>	honey-locust	31					5	Good	Good	Good	Good		10
513	<i>Gleditsia triacanthos</i>	honey-locust	53					5	Good	Good	Good	Good	Branches cut back from Hydro wires	10

TABLE 1. Detailed Tree Inventory, Bramalea Road Environmental Assessment, Brampton Ontario
Data collected: November 21st; November 22nd; November 27th, 2018

Tag #	Botanical Name	Common Name	DBH (cm)					Dripline Radius (m)	Condition				Comments	Required Tree Protection Zone (m)
			Stem 1	Stem 2	Stem 3	Stem 4	Stem 5		Trunk Integrity	Crown Structure	Crown Vigour	Overall Condition		
514	<i>Gleditsia triacanthos</i>	honey-locust	31					4	Good	Fair	Fair	Fair	Tree has been heavily pruned Back from Hydro wires and clearance from road	8
515	<i>Gleditsia triacanthos</i>	honey-locust	32					5.5	Good	Fair	Good	Fair	Pruned back from Hydro wires	11
516	<i>Gleditsia triacanthos</i>	honey-locust	32					6	Good	Good	Good	Good		12
517	<i>Gleditsia triacanthos</i>	honey-locust	26					5	Good	Good	Good	Good		5
518	<i>Gleditsia triacanthos</i>	honey-locust	36					6	Good	Good	Good	Good		12
519	<i>Gleditsia triacanthos</i>	honey-locust	35					6	Good	Good	Good	Good		12
520	<i>Gleditsia triacanthos</i>	honey-locust	33					5	Good	Good	Good	Good		10
521	<i>Gleditsia triacanthos</i>	honey-locust	28					5	Good	Good	Good	Good		5
522	<i>Gleditsia triacanthos</i>	honey-locust	32					5	Good	Good	Good	Good		10
523	<i>Gleditsia triacanthos</i>	honey-locust	38					4.5	Good	Good	Good	Good		9
524	<i>Gleditsia triacanthos</i>	honey-locust	23					4	Good	Good	Good	Good		4
525	<i>Gleditsia triacanthos</i>	honey-locust	33					4	Good	Good	Good	Good		8
526	<i>Gleditsia triacanthos</i>	honey-locust	32					5	Good	Good	Good	Good		10
527	<i>Gleditsia triacanthos</i>	honey-locust	30					4	Good	Good	Good	Good		4
528	<i>Gleditsia triacanthos</i>	honey-locust	30					5	Good	Good	Good	Good		5
529	<i>Gleditsia triacanthos</i>	honey-locust	30					5	Good	Good	Good	Good		5
530	<i>Gleditsia triacanthos</i>	honey-locust	30					5	Good	Good	Good	Good		5
531	<i>Gleditsia triacanthos</i>	honey-locust	30					5.5	Good	Good	Good	Good		5.5
532	<i>Gleditsia triacanthos</i>	honey-locust	31					5.5	Poor	Fair	Fair	Poor	Branch snapped off has left wound on trunk	11
533	<i>Gleditsia triacanthos</i>	honey-locust	32					5	Good	Good	Good	Good		10
534	<i>Gleditsia triacanthos</i>	honey-locust	33					4	Good	Good	Good	Good		8
535	<i>Gleditsia triacanthos</i>	honey-locust	29					4	Good	Good	Good	Good		4
536	<i>Gleditsia triacanthos</i>	honey-locust	32					4.5	Good	Good	Good	Good		9
537	<i>Gleditsia triacanthos</i>	honey-locust	37					4.5	Good	Good	Good	Good		9
538	<i>Gleditsia triacanthos</i>	honey-locust	31					4.5	Good	Good	Good	Good		9
539	<i>Gleditsia triacanthos</i>	honey-locust	25					4	Good	Fair	Fair	Fair	Aggressively pruned back from Hydro wires	4
540	<i>Acer negundo</i>	Manitoba maple	34	31	28	0	0	6	Good	Fair	Good	Fair	Aggressively pruned back from Hydro wires	12
541	<i>Gleditsia triacanthos</i>	honey-locust	29					4	Good	Good	Good	Good		4
542	<i>Acer platanoides</i>	Norway maple	21					3	Good	Poor	Fair	Poor	Aggressively prune back from Hydro wires	3
543	<i>Acer platanoides</i>	Norway maple	23					3.5	Good	Good	Good	Good		3.5
544	<i>Acer platanoides</i>	Norway maple	23					3.5	Good	Good	Good	Good		3.5
545	<i>Acer negundo</i>	Manitoba maple	23					4	Fair	Good	Good	Good	Growing out from fence towards sidewalk	4
546	<i>Ulmus pumila</i>	Siberian elm	18	20	20			5	Fair	Good	Good	Fair	Tree located adjacent to fence and property line buckthorn dense located between sidewalk in property line in this area. Canopy extends High over sidewalk	5
547	<i>Ulmus pumila</i>	Siberian elm	18	14	15	14	13	5	Fair	Good	Good	Fair	Tree located adjacent to fence and property line buckthorn dense located between sidewalk in property line in this area. Canopy extends High over sidewalk	5
548	<i>Ulmus pumila</i>	Siberian elm	15					4	Good	Good	Good	Good		4
549	<i>Ulmus pumila</i>	Siberian elm	10	28	28			6	Fair	Good	Good	Fair		6
550	<i>Ulmus pumila</i>	Siberian elm	16	10	26	12	18	6	Fair	Good	Good	Fair		6
551	<i>Ulmus pumila</i>	Siberian elm	14					4	Good	Fair	Good	Fair	Located directly adjacent to the fence property line	4
552	<i>Ulmus pumila</i>	Siberian elm	14	16	10			5	Good	Fair	Good	Fair	Located adjacent to fence property line	5
553	<i>Acer negundo</i>	Manitoba maple	20	18	18			5	Fair	Good	Good	Fair	Located directly adjacent to fence property line	5
554	<i>Acer platanoides</i>	Norway maple	24					3	Good	Fair	Good	Good	Pruned for lines	3
555	<i>Acer platanoides</i>	Norway maple	26					4.5	Good	Fair	Good	Good	Pruned for lines	4.5
556	<i>Acer platanoides</i>	Norway maple	28					4.5	Good	Fair	Good	Good	Pruned for lines, codominants with included bark	4.5
557	<i>Acer platanoides</i>	Norway maple	27					4.5	Good	Fair	Good	Good	Pruned for lines	4.5
558	<i>Acer platanoides</i>	Norway maple	27					4.5	Good	Fair	Good	Good	Pruned for lines	4.5
559	<i>Acer platanoides</i>	Norway maple	32					4.5	Good	Fair	Good	Good	Pruned for lines	9
560	<i>Acer platanoides</i>	Norway maple	20					3	Dead	Dead	Dead	Dead		3
561	<i>Acer platanoides</i>	Norway maple	20					3	Fair	Fair	Poor	Poor	Multiple attachments	3
562	<i>Acer platanoides</i>	Norway maple	31					4.5	Fair	Fair	Good	Fair	Broken leader on one codominant, trunk wound with deadwood	9
563	<i>Acer platanoides</i>	Norway maple	26					2	Poor	Poor	Poor	Poor	Two codominants removed, trunk wound with deadwood, borer holes	2
564	<i>Acer platanoides</i>	Norway maple	32					4.5	Good	Good	Good	Good	Pruned for lines	9

TABLE 1. Detailed Tree Inventory, Bramalea Road Environmental Assessment, Brampton Ontario
Data collected: November 21st; November 22nd; November 27th, 2018

Tag #	Botanical Name	Common Name	DBH (cm)					Dripline Radius (m)	Condition				Comments	Required Tree Protection Zone (m)
			Stem 1	Stem 2	Stem 3	Stem 4	Stem 5		Trunk Integrity	Crown Structure	Crown Vigour	Overall Condition		
565	<i>Acer platanoides</i>	Norway maple	28					4	Poor	Poor	Fair	Fair	One leader dead, two scaffolds dead, large trunk wound with deadwood, borer holes	4
566	<i>Acer platanoides</i>	Norway maple	26					4	Good	Good	Good	Good		4
567	<i>Acer platanoides</i>	Norway maple	17					2.5	Good	Fair	Fair	Fair		2.5
568	<i>Acer platanoides</i>	Norway maple	28					3.5	Good	Good	Good	Good		3.5
569	<i>Acer platanoides</i>	Norway maple	25					4	Good	Good	Good	Good	One dead scaffold, one dead branch	4
570	<i>Ulmus pumila</i>	Siberian elm	39					5	Good	Fair	Good	Good	Bow and sweep to scaffolds with high end weight	10
571	<i>Ulmus pumila</i>	Siberian elm	35					5	Good	Fair	Good	Good	Several previous scaffold failures	10
572	<i>Acer platanoides</i>	Norway maple	23					2	Poor	Poor	Fair	Poor	Pruned for lines 1/2, 3m wound on trunk with deadwood	2
573	<i>Acer platanoides</i>	Norway maple	22					3.5	Fair	Fair	Good	Fair	Pruned for lines, calloused trunk wounds	3.5
574	<i>Acer platanoides</i>	Norway maple	26					3.5	Good	Fair	Good	Fair	Pruned for lines 1/3	3.5
575	<i>Acer platanoides</i>	Norway maple	22					4	Good	Fair	Good	Good	One dead scaffold, calloused trunk wound	4
576	<i>Acer platanoides</i>	Norway maple	31					4	Good	Good	Good	Good		8
577	<i>Acer platanoides</i>	Norway maple	24					4	Good	Good	Good	Good		4
578	<i>Acer platanoides</i>	Norway maple	14					2.5	Poor	Good	Good	Fair	1.5 m trunk wound with deadwood	2.5
579	<i>Quercus rubra</i>	red oak	24					3	Good	Good	Good	Good	Multiple attachments	3
580	<i>Quercus macrocarpa</i>	bur oak	9					1	Good	Good	Good	Good		1
581	<i>Gleditsia triacanthos</i>	honey-locust	47					7	Good	Good	Good	Good	Multiple attachments	14
582	<i>Acer platanoides</i>	Norway maple	24					4	Good	Good	Good	Good		4
583	<i>Acer platanoides</i>	Norway maple	24					4	Poor	Good	Good	Fair	Cavity and decay at codominant union	4
584	<i>Tilia cordata</i>	little-leaf linden	10					2	Good	Good	Good	Good	In scrappy hedgerow	2
585	<i>Acer platanoides</i>	Norway maple	39					5.5	Good	Good	Good	Good	Pruned for lines	11
586	<i>Acer platanoides</i>	Norway maple	38					5	Good	Good	Good	Good	Pruned for lines	10
587	<i>Acer platanoides</i>	Norway maple	33					5	Good	Good	Good	Good		10
588	<i>Acer platanoides</i>	Norway maple	32					5	Good	Good	Good	Good		10
589	<i>Acer platanoides</i>	Norway maple	21					2	Poor	Poor	Poor	Poor	Significant trunk deadwood, dead leader and scaffolds	2
590	<i>Acer platanoides</i>	Norway maple	16					2	Dead	Dead	Dead	Dead		2
591	<i>Acer platanoides</i>	Norway maple	21					2	Poor	Poor	Poor	Poor	Trunk wound with deadwood, dead scaffold	2
592	<i>Acer platanoides</i>	Norway maple	41					4	Good	Fair	Good	Fair	Major scaffold pruned	8
593	<i>Acer platanoides</i>	Norway maple	44					4	Fair	Poor	Good	Fair	Several major scaffolds pruned	8
594	<i>Acer platanoides</i>	Norway maple	30					4	Good	Good	Good	Good		4
595	<i>Acer platanoides</i>	Norway maple	36					3	Poor	Poor	Poor	Poor	Several major scaffolds pruned, deadwood in crown	6
596	<i>Acer platanoides</i>	Norway maple	14					2	Dead	Dead	Dead	Dead	Leafed out last season but no buds are set	2
597	<i>Acer platanoides</i>	Norway maple	25					3.5	Fair	Poor	Poor	Poor	Dead scaffold and several dead branches	3.5
598	<i>Acer platanoides</i>	Norway maple	35					4.5	Poor	Poor	Good	Poor	Dead scaffold, much bracket on trunk	9
599	<i>Acer platanoides</i>	Norway maple	31					4.5	Good	Good	Good	Good		9
600	<i>Acer platanoides</i>	Norway maple	28					3	Poor	Poor	Poor	Poor	Dead scaffolds	3
601	<i>Acer platanoides</i>	Norway maple	22					2	Dead	Dead	Dead	Dead		2
602	<i>Acer platanoides</i>	Norway maple	18					3	Fair	Good	Good	Good	Trunk wound	3
603	<i>Acer platanoides</i>	Norway maple	31					4.5	Fair	Fair	Fair	Fair	Dead leader	9
604	<i>Acer platanoides</i>	Norway maple	42					5	Fair	Poor	Fair	Fair	Several dead scaffolds	10
605	<i>Acer platanoides</i>	Norway maple	31					4	Fair	Fair	Good	Fair	Several previous scaffold failures	8
606	<i>Acer platanoides</i>	Norway maple	31					4	Poor	Poor	Poor	Poor	Several dead scaffolds, loose bark and deadwood	8
607	<i>Acer platanoides</i>	Norway maple	28					4	Good	Good	Good	Good		4
P1	<i>Ulmus pumila</i>	Siberian elm	45					6	Good	Good	Good	Good	Located on private property directly adjacent to friends property line	12
P2	<i>Ulmus pumila</i>	Siberian elm	40	21				6	Fair	Poor	Fair	Poor	Tree located on private property smaller stem branch hangs low over sidewalk and extends all the way to the edge of the road	12
P3	<i>Ulmus pumila</i>	Siberian elm	50					7	Good	Good	Good	Good	Tree located on private property. One branch extended over sidewalk into the boulevard would need to be cut for construction	14

TABLE 2. General Tree Inventory, Bramalea Road Environmental Assessment, Brampton Ontario
Data collected: November 21st; November 22nd; November 27th, 2018

Unit #	Botanical Name	Common Name	Number	DBH Range (cm)	Dripline Radius (m)	Overall Condition	Comments
1	<i>Gleditsia triacanthos</i>	honey-locust	4	<10	1	Fair - Poor	Landscape buffer planting - GO commuter car park
	<i>Acer freemanii</i>	Freman maple	2	<10	1	Fair - Dead	Landscape buffer planting - GO commuter car park
	<i>Picea pungens</i>	Colorado spruce	5	<10	1	Good-Dead	Landscape buffer planting - GO commuter car park
	<i>Pinus mugo</i>	Mugo pine	4	<10	1	Fair - Dead	Landscape buffer planting - GO commuter car park
2	<i>Gleditsia triacanthos</i>	honey-locust	20	<10 - 25	1 - 5	Good - Poor	Private landscape strip - Canadian Tire
3	<i>Elaeagnus angustifolia</i>	Russian olive	~ 20	<10 - 15	1 - 3	Good - Poor	Hedgerow - GO commuter car park
4	<i>Pinus sylvestris</i>	honey-locust	5	<10	1	Good	Hedgerow
	<i>Elaeagnus angustifolia</i>	Colorado spruce	2	<10	1	Fair	Hedgerow

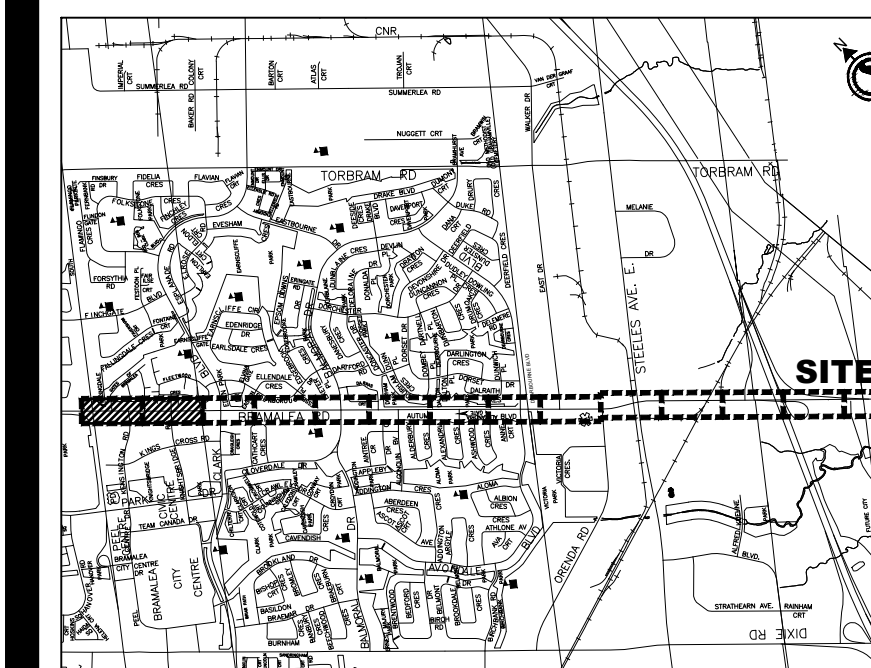

- Legend**
- Existing Edge of Pavement
 - Existing Curb
 - Existing Slope Face
 - Existing Swale
 - Existing Deciduous Tree
 - Existing Coniferous Tree
 - Dead Standing Tree
 - Minimum Tree Protection Zone
 - Existing Tree Identification Tag - Surveyed Location
 - Existing Tree Identification Tag - GPS Surveyed Location
 - Existing Vegetation Unit

VIEWPORT 1

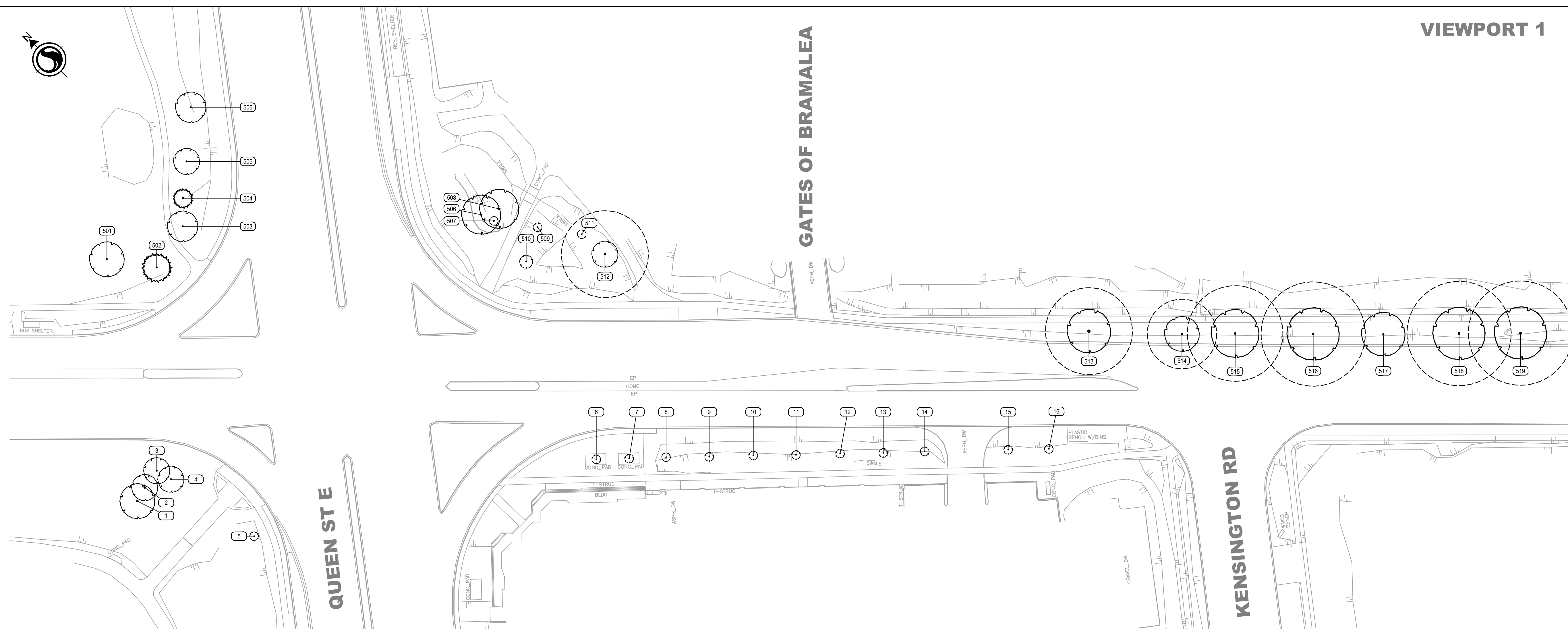

VIEWPORT 2

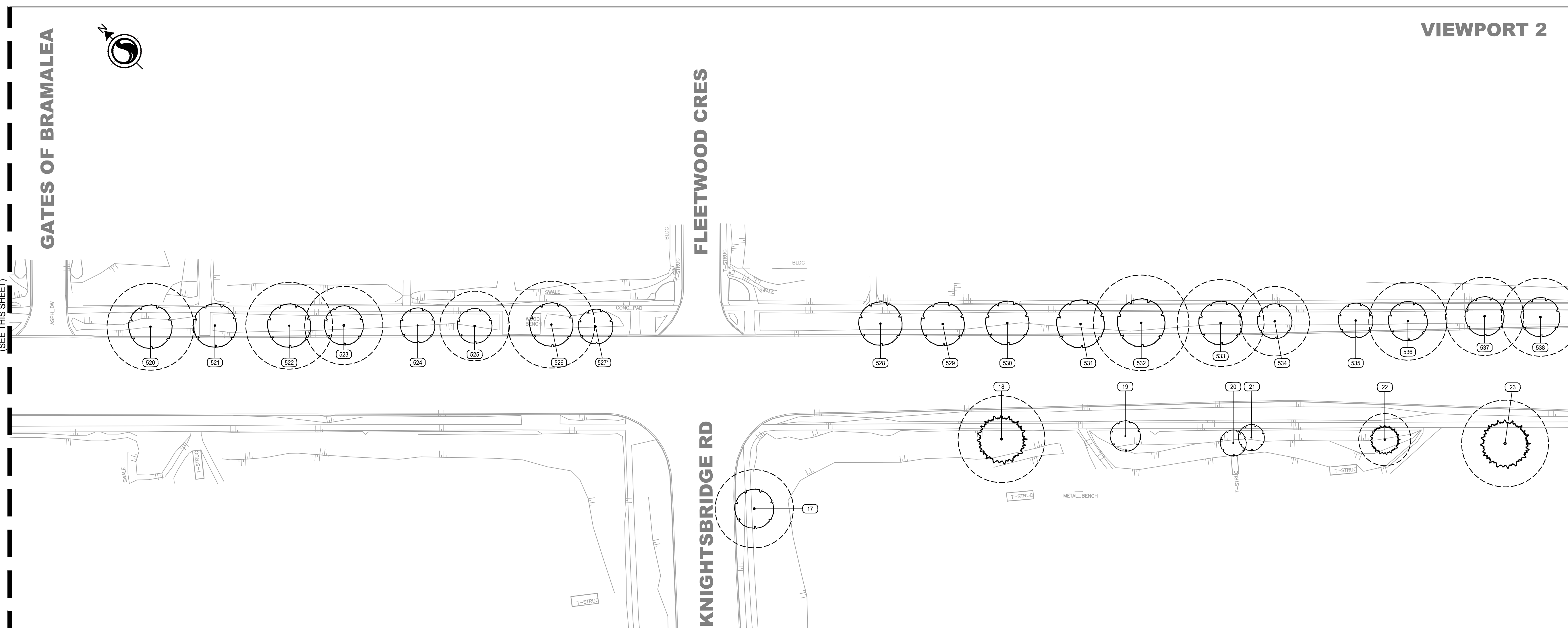

Revision/Issue	By	Appd	YYYY.MM.DD
File Name: 165010590_L-TM	LB	JJ	2018.12.13
	Dwn	Dsgn	Chkd. YYYY.MM.DD

Permit-Seal

Landon Black
0N-1876A

Jennifer Koskinen
0N-1234A

Client/Project
City of Brampton

Bramalea Road
Environmental Assessment

Brampton, Ontario







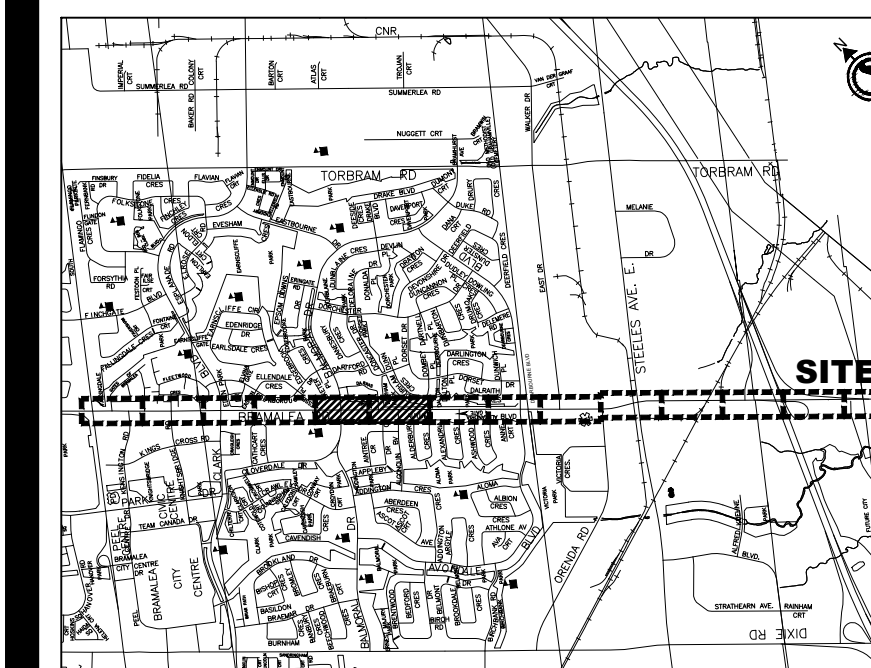

Title
Tree Inventory Plan
Detail Plan

Project No. 165010590
Scale 1:500

Revision 0 Sheet 2 of 8 Drawing No. L-901

C:\1515\165010590\165010590.dwg
 12/13/2018 11:13:20 AM
 165010590.dwg
 12/13/2018 11:13:20 AM
 165010590.dwg
 12/13/2018 11:13:20 AM
 165010590.dwg

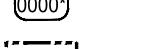
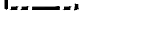

- Legend**
-  Existing Edge of Pavement
 -  Existing Curb
 -  Existing Slope Face
 -  Existing Swale
 -  Existing Deciduous Tree
 -  Existing Coniferous Tree
 -  Dead Standing Tree
 -  Minimum Tree Protection Zone
 -  Existing Tree Identification Tag - Surveyed Location
 -  Existing Tree Identification Tag - GPS Surveyed Location
 -  Existing Vegetation Unit

Revision/Issue	By	Appd	YYYY.MM.DD

File Name:	LB	LB	JJ	2018.12.13
165010590_L-TM				

Permit-Seal	LB	LB	JJ	2018.12.13



Client/Project
City of Brampton

Bramalea Road
Environmental Assessment
Brampton, Ontario

Title
Tree Inventory Plan
Detail Plan

Project No.	Scale
165010590	1:500

Revision	Sheet	Drawing No.
0	4 of 8	L-903

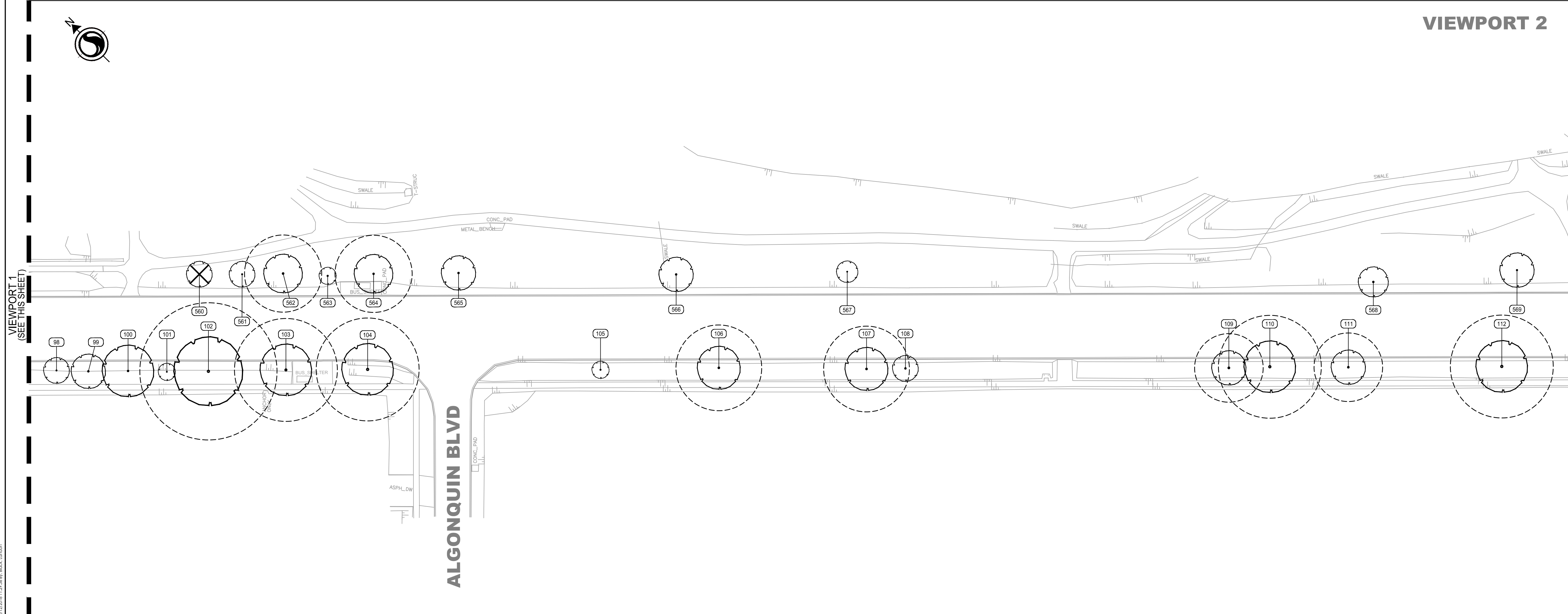
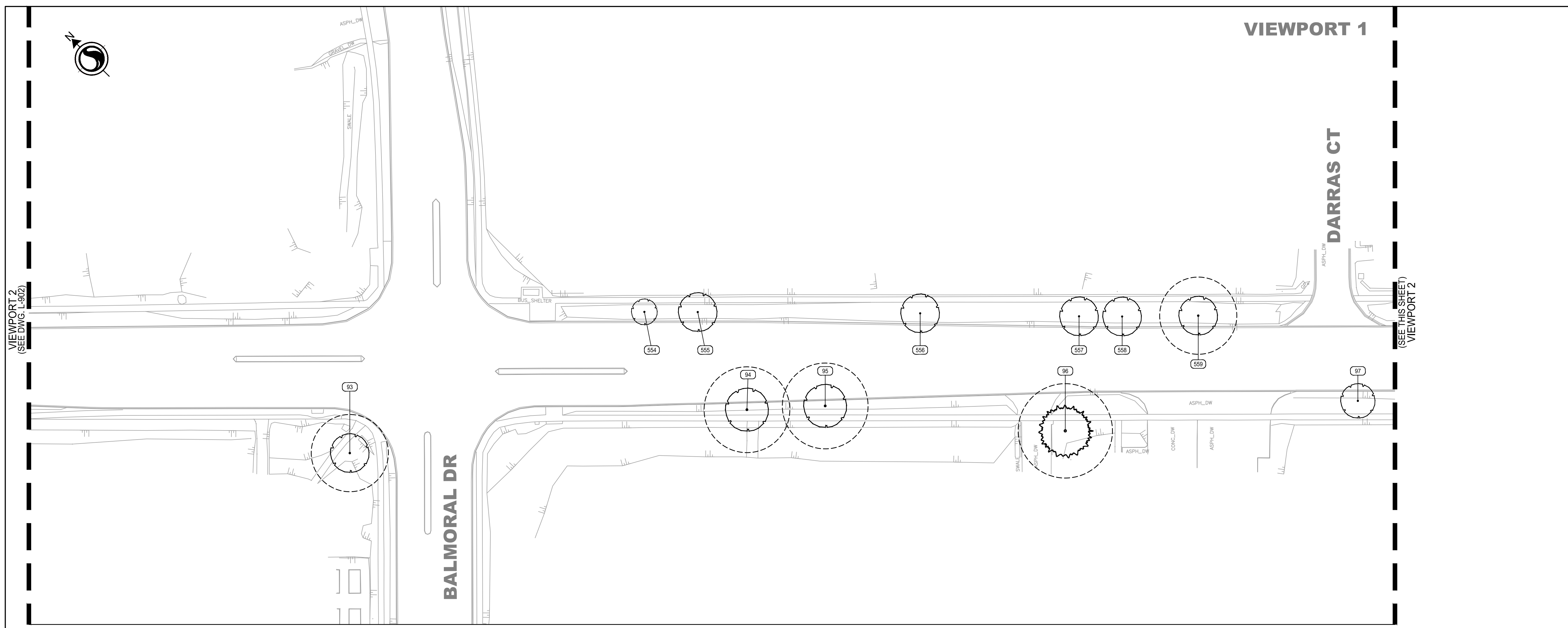

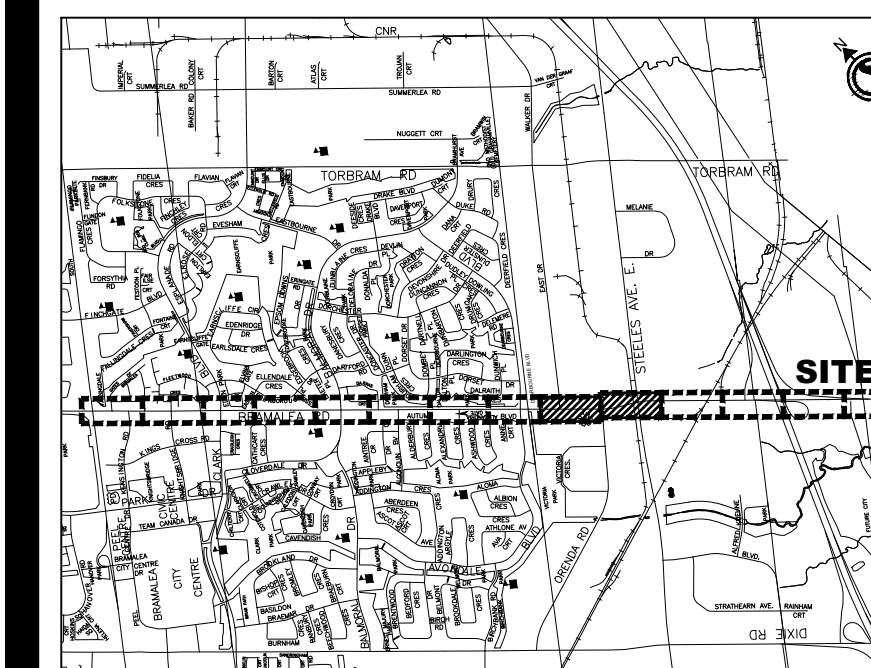

Legend

	Existing Edge of Pavement
	Existing Curb
	Existing Slope Face
	Existing Swale
	Existing Deciduous Tree
	Existing Coniferous Tree
	Dead Standing Tree
	Minimum Tree Protection Zone
	Existing Tree Identification Tag - Surveyed Location
	Existing Tree Identification Tag - GPS Surveyed Location
	Existing Vegetation Unit

Revision/Issue	By	Appd	YYYY.MM.DD

File Name: 165010590_L-TM LB LB JJ 2018.12.13
Dwn. Dsgn. Chkd. YYYY.MM.DD

Permit-Seal

Landon Black
ON-1876A

Jennifer Koskinen
ON-1234A

Client/Project
City of Brampton

Bramalea Road
Environmental Assessment

Brampton, Ontario

Title
Tree Inventory Plan
Detail Plan

Project No. 165010590 Scale 1:500

Revision Sheet 0 6 of 8 Drawing No. L-905

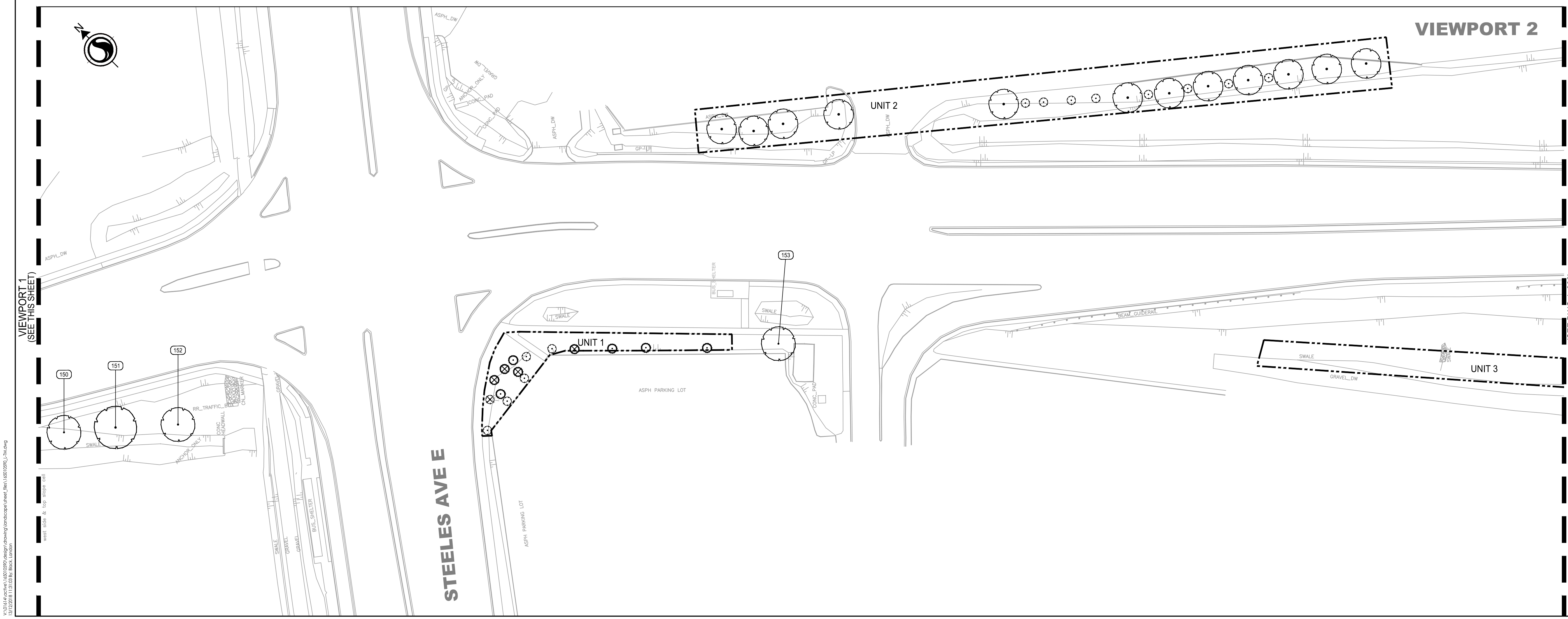
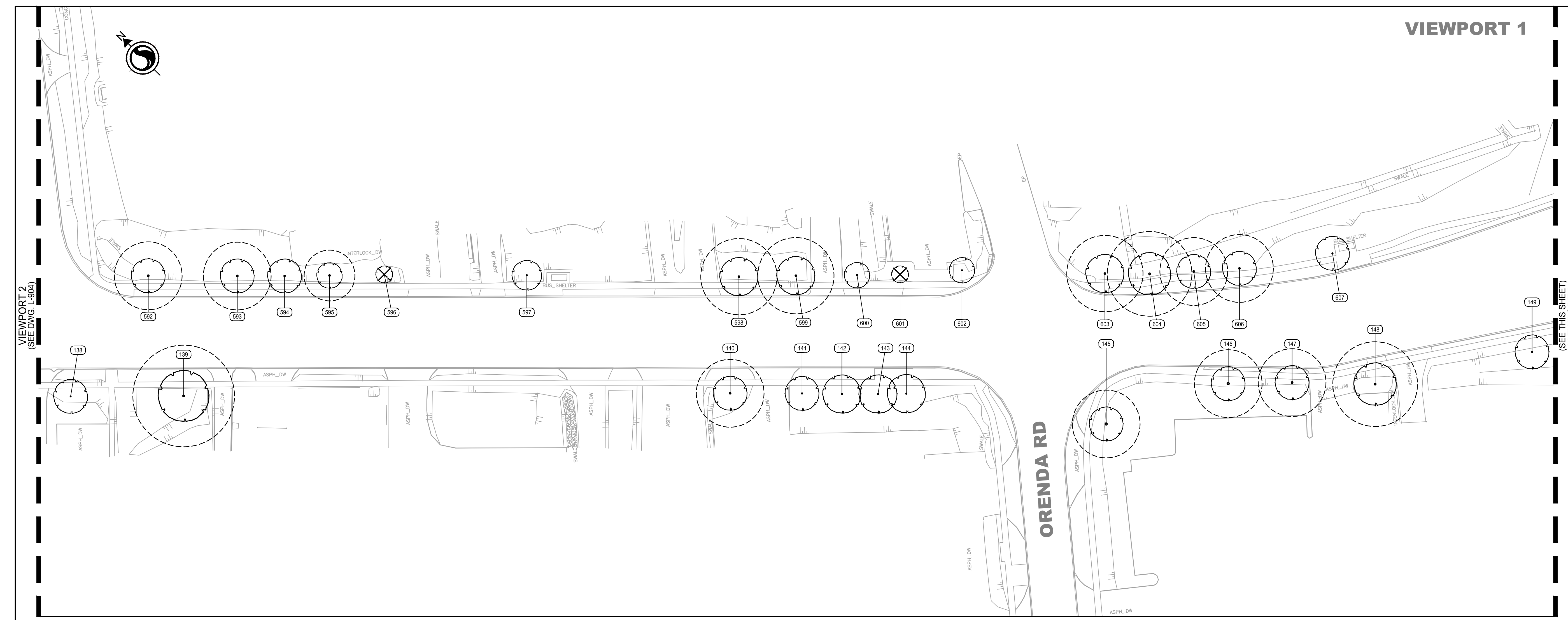

Copyright Reserved
The Contractor shall verify and be responsible for all dimensions. DO NOT scale the drawing - any errors or omissions shall be reported to Stantec without delay.
The Copyrights to all designs and drawings are the property of Stantec. Reproduction or use for any purpose other than that authorized by Stantec is forbidden.

Key Map NTS.

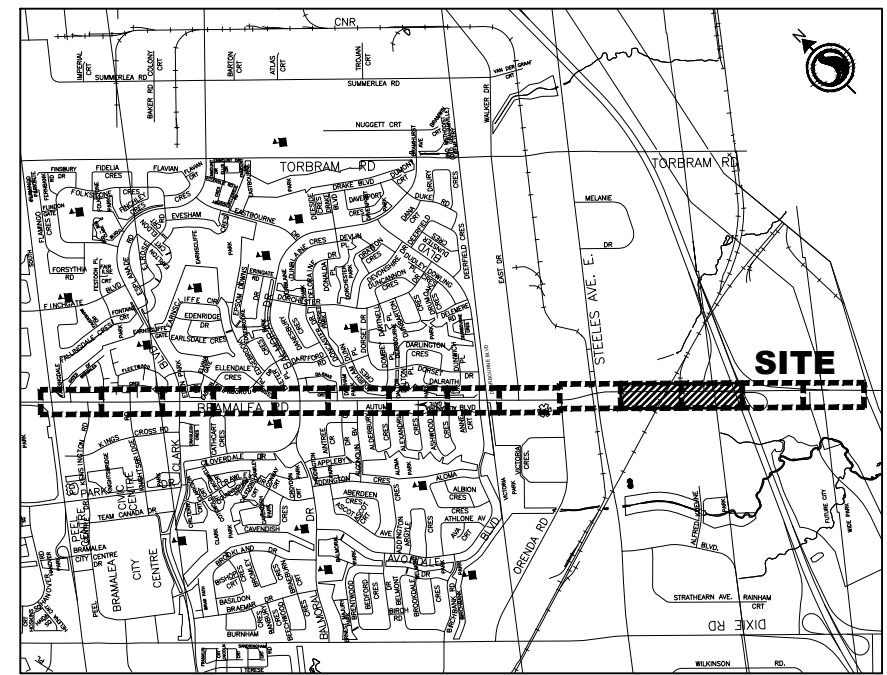

Legend

- Existing Edge of Pavement
- Existing Curb
- Existing Slope Face
- Existing Swale
- Existing Deciduous Tree
- Existing Coniferous Tree
- Dead Standing Tree
- Minimum Tree Protection Zone
- Existing Tree Identification Tag - Surveyed Location
- Existing Tree Identification Tag - GPS Surveyed Location
- Existing Vegetation Unit

Revision/Issue	By	Appd	YYYY.MM.DD

File Name:	LB	JJ	2018.12.13
165010590_L-TM	Dwn.	Dsgn.	Chkd.

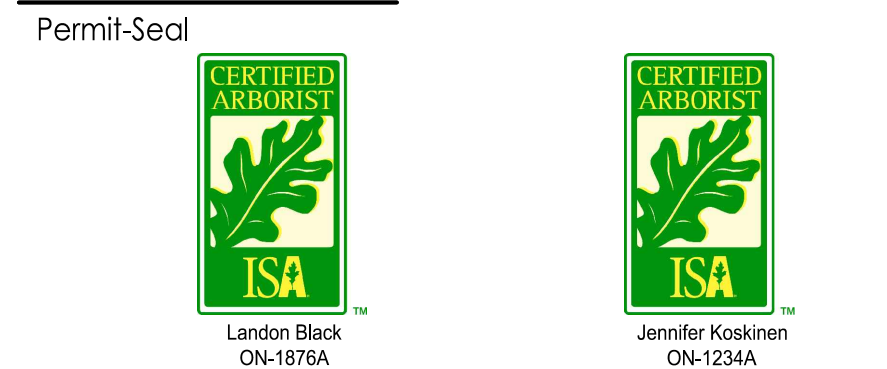

Client/Project
City of Brampton

Bramalea Road
Environmental Assessment
Brampton, Ontario

Title
Tree Inventory Plan
Detail Plan

Project No. 165010590
Scale 1:500

Revision 0 Sheet 7 of 8 Drawing No. L-906

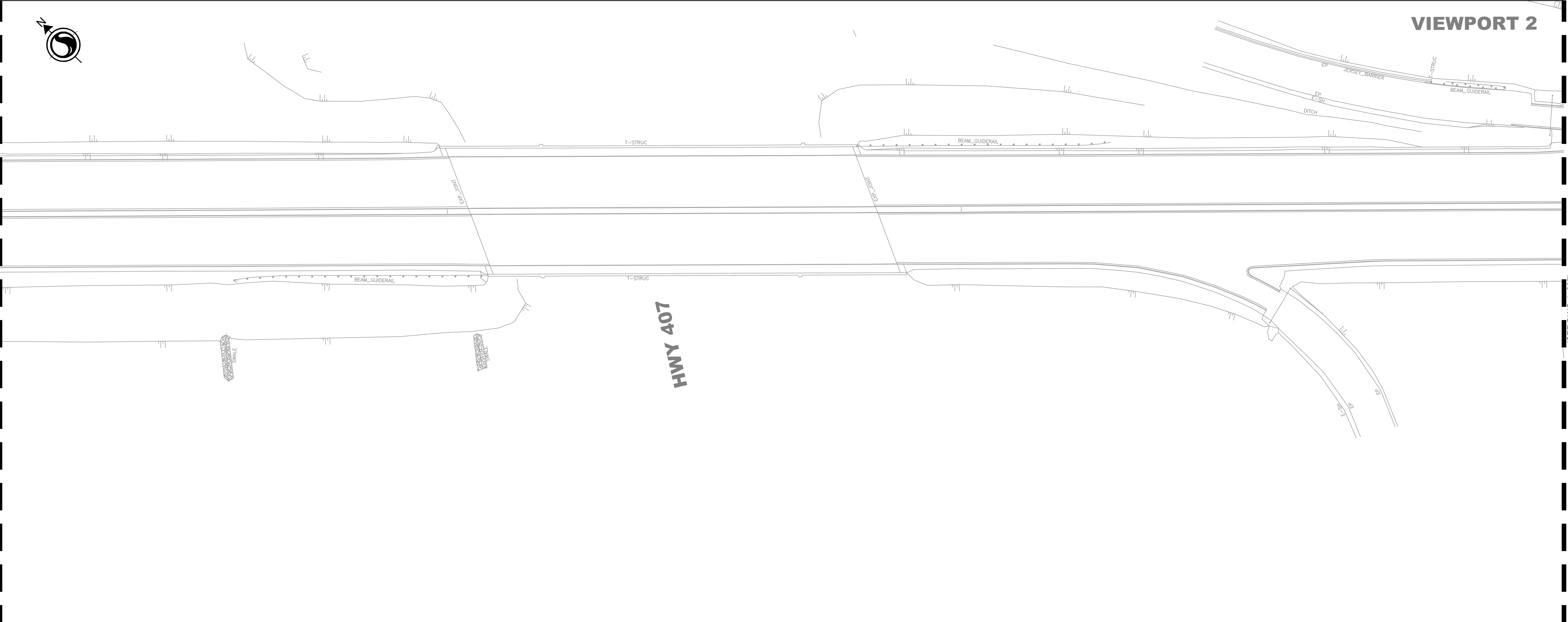
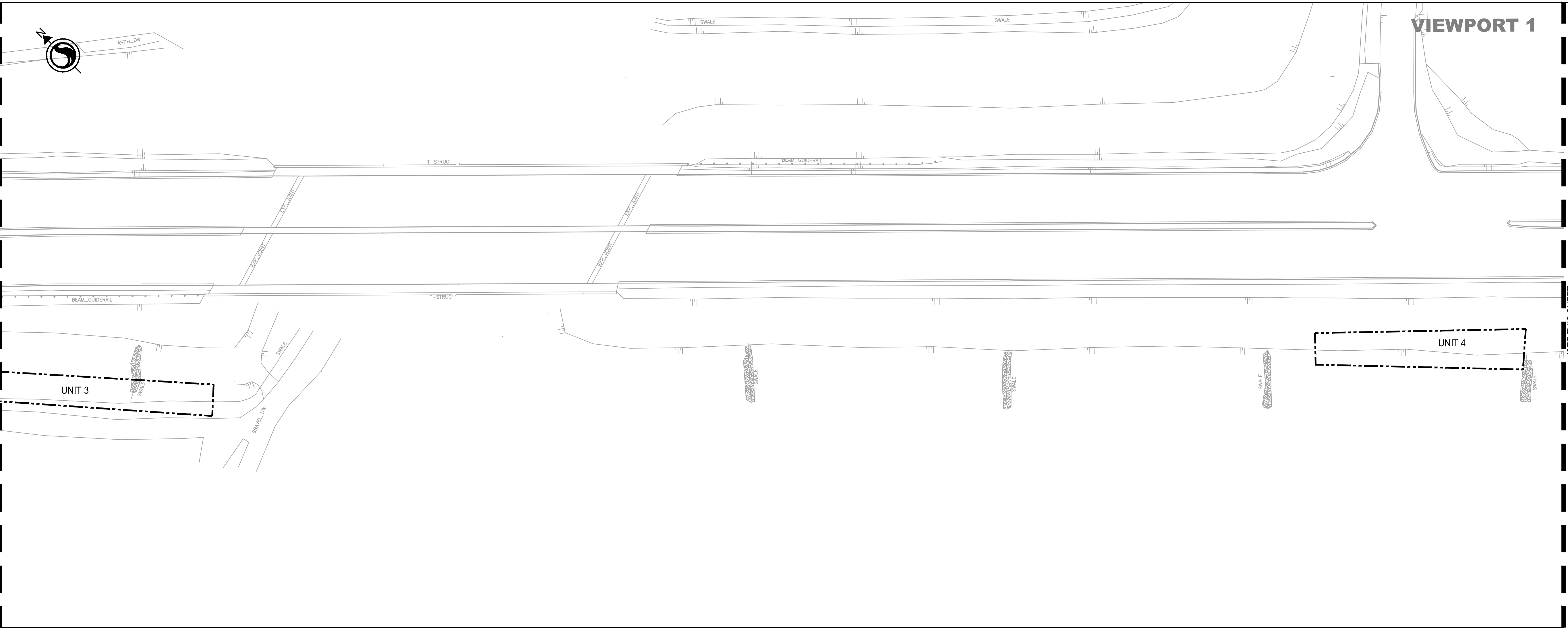

Copyright Reserved

The Contractor shall verify and be responsible for all dimensions. DO NOT scale the drawing - any errors or omissions shall be reported to Stantec without delay.
The Copyrights to all designs and drawings are the property of Stantec. Reproduction or use for any purpose other than that authorized by Stantec is forbidden.

Key Map NTS.

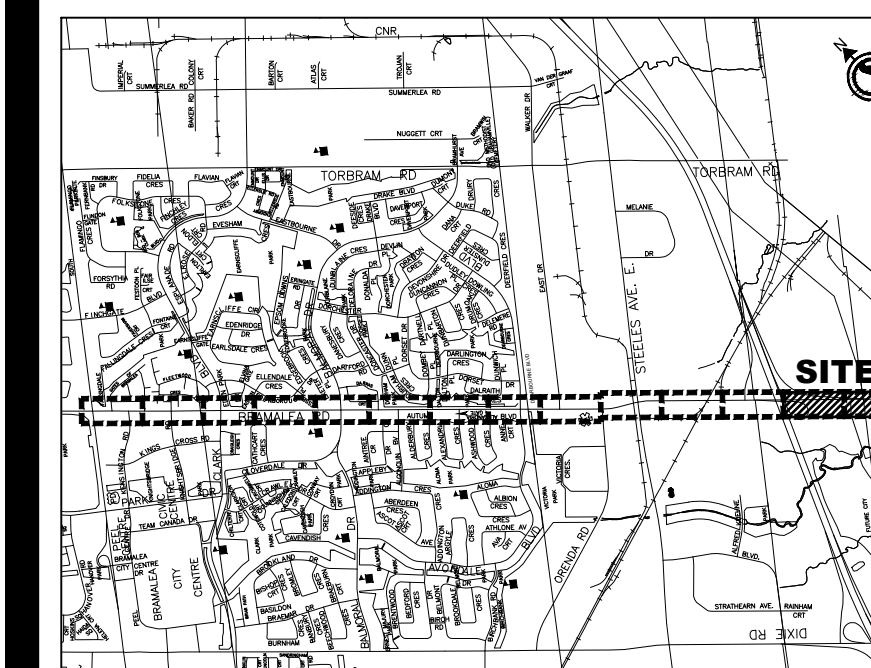

Legend

- Existing Edge of Pavement
- Existing Curb
- Existing Slope Face
- Existing Swale
- Existing Deciduous Tree
- Existing Coniferous Tree
- Dead Standing Tree
- Minimum Tree Protection Zone
- Existing Tree Identification Tag - Surveyed Location
- Existing Tree Identification Tag - GPS Surveyed Location
- Existing Vegetation Unit

Revision/Issue	By	Appd	YYYY.MM.DD

File Name:	LB	LB	JJ	2018.12.13
165010590_L-TM	Dwn.	Dsgn.	Chkd.	YYYY.MM.DD

Permit-Seal



Client/Project
City of Brampton

Bramalea Road
Environmental Assessment

Brampton, Ontario

Title
Tree Inventory Plan
Detail Plan

Project No. 165010590
Scale 1:500

Revision Sheet 0 of 8
Drawing No. L-907

