

PHASE 2: INTEGRATED RIVERINE AND URBAN FLOOD RISK ANALYSIS

Report Prepared for:
THE CITY OF BRAMPTON

Prepared by:
MATRIX SOLUTIONS INC.
DANISH HYDRAULIC INSTITUTE (DHI CANADA)

Version 1.0
March 2019
Guelph, Ontario

Unit 7B, 650 Woodlawn Rd. West
Guelph, ON, Canada N1K 1B8
T 519.772.3777 F 519.648.3168
www.matrix-solutions.com

BRAMPTON INTEGRATED RIVERINE AND URBAN FLOOD RISK ANALYSIS

Final Report edit prepared for the City of Brampton, March 2019



Kelly Molnar, P.Eng. *March 19, 2019*
Water Resources Engineer
Matrix Solutions Inc.

reviewed by
Karen Hofbauer, M.A.Sc., P.Eng.
Senior Water Resources Engineer
Matrix Solutions Inc.

A large, stylized handwritten signature in blue ink, appearing to read "Pat Delaney".

contributor
Patrick Delaney, M.A.Sc., P.Eng.
President
DHI Canada

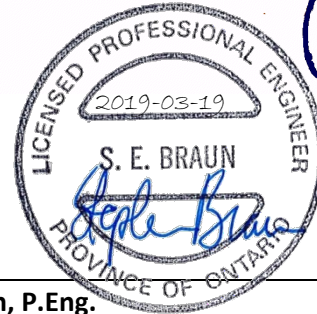

reviewed by
Stephen Braun, P.Eng.
Senior Water Resources Engineer
Matrix Solutions Inc.

DISCLAIMER

Matrix Solutions Inc. certifies that this report is accurate and complete and accords with the information available during the project. Information obtained during the project or provided by third parties is believed to be accurate but is not guaranteed. Matrix Solutions Inc. has exercised reasonable skill, care, and diligence in assessing the information obtained during the preparation of this report.

This report was prepared for City of Brampton. The report may not be relied upon by any other person or entity without the written consent of Matrix Solutions Inc. and of City of Brampton. Any uses of this report by a third party, or any reliance on decisions made based on it, are the responsibility of that party. Matrix Solutions Inc. is not responsible for damages or injuries incurred by any third party, as a result of decisions made or actions taken based on this report.

VERSION CONTROL

Version	Date	Issue Type	Filename	Description
V0.1	09-Apr-2018	Draft	22062-522 Phase 2 R 2018-04-09 draft V0.1	Issued to client for review
V1.0	19-Mar-2019	Final	22062-522 Phase 2 R 2019-03-19 final V1.0	Final issued to client for review

EXECUTIVE SUMMARY

The City of Brampton (City) initiated the *Phase 2: Integrated Riverine and Urban Flood Risk Analysis and Urban Design Study* (Phase 2 study) to build upon previous studies and to more definitively characterize current flood risks in Downtown Brampton. Potential mitigation strategies are also explored and outlined.

The study area is focused on Downtown Brampton Special Policy Area #3 (SPA 3), caused by flooding from nearby Etobicoke Creek during a Regulatory Storm event. The two foundational elements of the Phase 2 study, flood risk and urban design, were integrated together to allow a thorough and holistic exploration of potential and feasible options available to the City. Flood modelling tasks and urban design tasks correspond to Parts 1 and 2 of the Phase 2 study. SGL Planning & Design Inc. and FORREC Ltd. together led urban design aspects for the project which are presented under separate cover. This current technical report addresses and is focused on Part 1 study topics which include flood risk identification, technical flood modelling, and exploration of mitigation options.

Due to the urban nature of the floodplain and complexity of spill areas, a new 3-way integrated hydraulic model was developed and calibrated. The model allows for interaction between storm sewers, the Etobicoke Creek channel, and overland flow portions which represent both the floodplain (i.e., the above-bank riverine flows) and also the urban-derived flows exceeding the storm sewers. The current study through its newly developed 3-way model evaluates, refines, and builds upon previously short-listed flood mitigation alternatives (Phase 1 report, AMEC 2016) through a more integrated understanding of the different types of flooding processes that occur at this site. The study also allows a much clearer vision and better understanding of existing flood risks experienced within SPA #3 through its highly graphical presentations which comprise a key component of this report.

This Phase 2 report outlines flood mitigation alternatives for the downtown core, including addressing key design features and considerations (hydraulic and otherwise) that will be relevant for the City's consideration of their planned *Riverwalk* project. The report goes on to identify the feasibility of some mitigation approaches and the predicted effectiveness for addressing flooding concerns related to SPA 3. The report also outlines cost estimates and some potential issues related to flooding mitigation that will be necessary to consider within future Environmental Assessment tasks.

TABLE OF CONTENTS

EXECUTIVE SUMMARY	IV
1 INTRODUCTION	1
1.1 Project Summary and Report Scope	1
1.2 Study Area and Overview	2
2 BACKGROUND REVIEW	5
2.1 Previous and Ongoing Studies	5
2.1.1 Etobicoke Creek Hydrology Update (MMM 2013)	5
2.1.2 Downtown Brampton Drainage Study	5
2.1.2.1 Part 1 - Flood Risk Assessment (Aquafor 2006)	5
2.1.2.2 Part 2 - Stormwater Management (Aquafor 2008)	6
2.1.3 Brampton Central Area Sustainable Infrastructure Study Baseline Review (WSP 2014)	6
2.1.4 Downtown Brampton Special Policy Area Comprehensive Flood Risk and Management Analysis (City of Brampton 2014a)	6
2.1.5 Downtown Brampton Etobicoke Creek Revitalization Study	6
2.1.5.1 Part 1 - Downtown Brampton Flood Protection Feasibility Study (AMEC 2016)	6
2.1.5.2 Part 2 - Urban Design & Land Use Study (City of Brampton 2014b)	7
2.1.6 Downtown Brampton Floodplain Mapping Update (Valdor 2017)	7
2.1.7 Waste Delineation and Characterization Report, Centennial Park and Center Park Landfill Areas (WSP 2018)	8
2.2 Data Collection and Preparation	8
2.2.1 Data Acquisition	8
2.2.2 Minor System Invert Data	8
2.2.2.1 Manhole Survey Selection Criteria	9
2.2.2.2 Invert Data from Downtown Drainage Study Model	9
2.2.2.3 Invert Data Filling	9
2.2.2.4 Spatial Processing	10
2.2.3 Site Walk	10
3 EXISTING CONDITIONS MODEL DEVELOPMENT	13
3.1 1D Urban Model Development	13
3.1.1 Urban Catchments	15
3.1.1.1 Catchment Delineation	15
3.1.1.2 Catchment Hydrologic Parameters	15
3.1.2 Sewer Network	16
3.1.2.1 Pipes	16
3.1.2.2 Manholes and Catch Basins	17
3.1.2.3 Catchment Connections	17

3.1.3	Urban Model Boundary Conditions	18
3.1.3.1	Rainfall	18
3.1.3.2	Outfalls.....	19
3.1.4	1D Urban Simulation Settings.....	19
3.2	1D Riverine Model Development	19
3.2.1	Riverine Catchments.....	21
3.2.2	Channel Geometry.....	21
3.2.2.1	River Centreline	21
3.2.2.2	Cross-sections	21
3.2.3	Channel Roughness.....	24
3.2.4	Structures.....	24
3.2.5	Riverine Model Boundary Conditions.....	25
3.2.5.1	Inflow Hydrographs	26
3.2.5.2	Downstream Rating Curve	27
3.2.6	1D Riverine Simulation Settings.....	27
3.3	2D Overland Model Development.....	27
3.3.1	Topography.....	29
3.3.1.1	Obstructions.....	29
3.3.1.2	River Block Removal.....	29
3.3.2	Surface Roughness.....	29
3.3.3	2D Overland Model Boundary Conditions.....	30
3.3.4	2D Overland Simulation Settings	30
3.4	3-Way Coupled Model Development	30
3.4.1	1D-2D Urban Coupling	31
3.4.1.1	CB Inflow	31
3.4.1.2	Catch Basin Surcharge.....	32
3.4.1.3	Manhole Inflow.....	32
3.4.1.4	Manhole Surcharge.....	33
3.4.2	1D-2D Riverine Coupling.....	34
3.4.3	1D Urban-1D Riverine Coupling	34
3.4.4	3-Way Coupling.....	34
4	MODEL CALIBRATION AND VALIDATION	34
4.1	Flow Monitoring Data Review	35
4.1.1	Analysis of Measured Rainfall.....	36
4.1.2	Correlating Measured Flow to Rainfall Data.....	38
4.1.3	Monitoring Station Variation	42
4.1.4	Calibration and Validation Event Selection	44
4.2	Urban Model Calibration Methodology.....	44
4.2.1	Hydrologic Model.....	44
4.2.2	Calibration Parameters	45

4.3	Urban Model Calibration Results	46
4.3.1	Etobicoke Station	46
4.3.2	Church Station	48
4.3.3	Summary	50
4.4	Riverine Model Validation	50
4.4.1	Comparison of Water Surfaces	50
4.4.2	Impacts of Low Flow Channel	51
5	CHARACTERIZATION OF EXISTING FLOOD RISK	53
5.1	Design Storm Runs	54
5.2	Flood Characterization	55
5.2.1	Flood Mechanisms	56
5.2.1.1	Riverine Flooding	56
5.2.1.2	Urban Flooding	58
5.2.2	Discussion	62
6	CRITERIA AND BEST PRACTICES FOR FLOOD MITIGATION OPTIONS	65
6.1	Flood Risk Mitigation Options	65
6.2	Flood Protection Landforms	65
6.3	City Road Design Guidelines	66
6.4	Floodplain Conveyance Improvements	67
7	ASSESSMENT OF PHASE 1 ALTERNATIVES	68
7.1	Ellen Street Flood Protection Landform	68
7.2	Lower Bypass Channel	69
7.3	Phase 1 Combination 2 (Ellen Street FPL + Lower Bypass Channel)	69
7.4	Tailwater Flood Protection Landform	70
7.5	Clarence Street Bridge Widening	70
7.6	Discussion of Phase 1 Alternatives	71
8	REFINED FLOOD MITIGATION ALTERNATIVES	71
8.1	Upstream Options	73
8.1.1	Upstream Option A: Ellen Street FPL	74
8.1.2	Upstream Option B: Reconnected Floodplain	77
8.1.3	Upstream Option C: Bypass Channel Entrance Feature	80
8.2	Downstream Options	82
8.2.1	Downstream Option 1: Centre Street Landfill Removal	82
8.2.2	Downstream Option 2: Centennial Park Landfill Removal	85
8.2.3	Downstream Option 3: Removal of Both Landfills	86
8.3	Riverwalk Widened Channel Options	89
8.3.1	Bypass Channel Manning's n Assessment	89
8.3.2	Riverwalk Within Lowered Bypass Channel	89
8.3.3	Riverwalk and Removal of Drop Structures in Bypass Channel	90
8.3.4	Riverwalk Option without Floodplain Enhancement	97

8.4	Discussion of Refined Alternatives	102
8.4.1	Upstream Options.....	102
8.4.2	Downstream Options.....	102
8.4.3	Riverwalk Widened Channel Options	103
8.5	Other Considerations for Future Studies.....	103
8.5.1	Design of Bridges over Bypass Channel	103
8.5.2	Urban Drainage Network Modifications.....	104
9	IMPLEMENTATION PLAN AND COST ESTIMATE.....	104
9.1	Recommendations for Environmental Assessment.....	104
9.2	Cost Estimates.....	105
9.3	Municipal Class Environmental Assessment Requirements	106
10	REFERENCES.....	107

LIST OF FIGURES

Figure 1	Study Area.....	4
Figure 2	Site Walk Route Map	12
Figure 3	1D Urban Model Schematic.....	14
Figure 4	1D Riverine Model Schematic.....	20
Figure 5	Comparison of Full Cross-Section and Trimmed Cross-Section	22
Figure 6	Cross-Section Comparison, LiDAR vs. Survey (Image Credit: TRCA)	23
Figure 7	Bridge Modelling Schematic with Combined Culvert and Weir	25
Figure 8	2D Riverine Model Schematic.....	28
Figure 9	Catch Basin Inlet Capacity at Road Sag (Image Credit: MTO 1997)	32
Figure 10	Flow Monitoring Station Locations.....	36
Figure 11	Comparison of Rainfall Depth and Measured Flow - Etobicoke Station.....	38
Figure 12	Comparison Rainfall Depth and Measured Flow - Church Station	39
Figure 13	Scatter Plot of Peak Flow vs. Peak Rainfall Intensity	39
Figure 14	Rainfall Depth vs. Measured Flow - Etobicoke Station May 27	40
Figure 15	Rainfall Depth vs. Measured Flow - Church Station May 27	40
Figure 16	Rainfall Depth vs. Measured Flow - Etobicoke Station June 3 to 5	41
Figure 17	Rainfall Depth vs. Measured Flow - Church Station June 3 to 5	41
Figure 18	Rainfall Depth vs. Measured Flow - Etobicoke Station July 18 to 19.....	42
Figure 19	Rainfall Depth vs. Measured Flow - Church Station July 18 to 19	42
Figure 20	Contributing Catchment Areas for Flow Monitoring Stations	43
Figure 21	Normalized Flow vs. Rainfall Depth	43
Figure 22	Measured vs. Modelled Flow - Etobicoke Station July 18 to 19	47
Figure 23	Measured vs. Modelled Flow - Etobicoke Station June 3 to 5.....	47
Figure 24	Measured vs. Modelled Flow - Etobicoke Station May 27	48
Figure 25	Measured vs. Modelled Flow - Church Station July 18 to 19.....	49
Figure 26	Measured vs. Modelled Flow - Church Station June 3 to 5	49
Figure 27	Measured vs. Modelled Flow - Church Station May 27	50
Figure 28	Comparison of Water Level between MIKE 11 and HEC-RAS for 50-Year Event.....	51
Figure 29	Cross-Section Comparison between MIKE 11 and HEC-RAS.....	52
Figure 30	MIKE 11 vs. HEC-RAS Water Levels with and without Low Flow Channel.....	53
Figure 31	Urban: 10-year Chicago, River: 10-year AES Diverted Runoff and Surcharged Nodes.....	60

Figure 32	Flood Zones.....	63
Figure 33	Upstream Option A Schematic and Results	76
Figure 34	Upstream Option B Schematic and Results	79
Figure 35	Upstream Option C Schematic and Results	81
Figure 36	Downstream Option 1 Schematic and Results	84
Figure 37	Downstream Option 2 Schematic and Results	87
Figure 38	Downstream Option 3 Schematic and Results	88
Figure 39	Sanitary Realignment Concept	91
Figure 40.1	Regional Storm - Maximum Depth, Riverwalk + Drop Structure Removal	93
Figure 40.2	Regional Storm - Maximum Velocity, Riverwalk + Drop Structure Removal.....	94
Figure 40.3	Regional Storm - Maximum Depth × Velocity, Riverwalk + Drop Structure Removal	95
Figure 40.4	Regional Storm - Flood Risk, Riverwalk + Drop Structure Removal.....	96
Figure 41.1	Regional Storm - Maximum Depth, Riverwalk Option without Floodplain Enhancement	98
Figure 41.2	Regional Storm - Maximum Velocity, Riverwalk Option without Floodplain Enhancement	99
Figure 41.3	Regional Storm - Maximum Depth × Velocity, Riverwalk Option without Floodplain Enhancement	100
Figure 41.4	Regional Storm - Flood Risk, Riverwalk Option without Floodplain Enhancement.....	101

LIST OF TABLES

Table 1	Urban Catchment Pervious and Impervious, Land Use Type, and Manning’s n.....	16
Table 2	Coincident Catch Basins and Manholes	17
Table 3	Cross-Section Manning’s n Values	24
Table 4	Bridge Data	24
Table 5	MIKE 11 Boundary Conditions	25
Table 6	MIKE 11 Peak Flows	26
Table 7	Downstream Q-h Rating Curve	27
Table 8	Manning’s Roughness Values	29
Table 9	Depth-Flow Curve for Manhole Inflow	33
Table 10	Analysis of Rainfall vs. Measured Flow	37
Table 11	Summary of Kinematic Wave Hydrologic Model Parameters	45
Table 12	Kinematic Wave Hydrologic Parameters	46
Table 13	Comparison of Measured and Modelled Event Volumes at Etobicoke Station	48
Table 14	Existing Condition Model Runs	55
Table 15	Flood Risk Criteria	56
Table 16	Bridge Capacity	57
Table 17	Nodes with Inlet Capacity Issues	58
Table 18	Nodes with Surcharge.....	61
Table 19	Right-of-Way Conveyance	62
Table 20	Flood Zones.....	64
Table 21	Model Simulation Summary	73
Table 22	MIKE 11 Result Summary (without MIKE URBAN) – Upstream Option A.....	75
Table 23	MIKE 11 Result Summary (without MIKE URBAN) – Upstream Option B.....	78
Table 24	MIKE 11 Result Summary (without MIKE URBAN) – Upstream Option C.....	80
Table 25	MIKE 11 Result Summary (without MIKE URBAN) – Downstream Option 1	83
Table 26	MIKE 11 Result Summary (without MIKE URBAN) – Downstream Option 2	85

Table 27	MIKE 11 Result Summary (without MIKE URBAN) – Downstream Option 3	86
Table 28	Recommended Bridge Span.....	92
Table 29	Short-Listed Alternatives for Environmental Assessment	105
Table 30	Capital Cost Estimate	106

MAP SET

MAPS 1.1 to 1.4	Regional Storm - Steady State (Depth, Velocity, Depth × Velocity, Flood Risk)
MAPS 2.1 to 2.4	Regional Storm - Unsteady State (Depth, Velocity, Depth × Velocity, Flood Risk)
MAPS 3.1 to 3.4	350-year Storm - Steady State (Depth, Velocity, Depth × Velocity, Flood Risk)
MAPS 4.1 to 4.4	350-year Storm - Unsteady State (Depth, Velocity, Depth × Velocity, Flood Risk)
MAPS 5.1 to 5.4	100-year Storm - Unsteady State (Depth, Velocity, Depth × Velocity, Flood Risk)
MAPS 6.1 to 6.4	50-year Storm - Unsteady State (Depth, Velocity, Depth × Velocity, Flood Risk)
MAPS 7.1 to 7.4	25-year Storm - Unsteady State (Depth, Velocity, Depth × Velocity, Flood Risk)
MAPS 8.1 to 8.4	10-year Storm - Unsteady State (Depth, Velocity, Depth × Velocity, Flood Risk)
MAPS 9.1 to 9.4	5-year Storm - Unsteady State (Depth, Velocity, Depth × Velocity, Flood Risk)
MAPS 10.1 to 10.4	2-year Storm - Unsteady State (Depth, Velocity, Depth × Velocity, Flood Risk)
MAPS 11.1 to 11.4	Urban: 100-year Chicago, River: 100-year AES (Depth, Velocity, Depth × Velocity, Flood Risk)
MAPS 12.1 to 12.4	Urban: 10-year Chicago, River: 10-year AES (Depth, Velocity, Depth × Velocity, Flood Risk)
MAPS 13.1 to 13.4	Urban: 100-year Chicago, River: Regional Storm (Depth, Velocity, Depth × Velocity, Flood Risk)

APPENDICES

APPENDIX A	Record of Received Data
APPENDIX B	Manhole Survey Selection Memorandum
APPENDIX C	Sewer Infilling Memorandum
APPENDIX D	Site Photographs
APPENDIX E	Burton Park Catchment Memorandum
APPENDIX F	Preliminary Alternative Assessment Memorandum
APPENDIX G	Bypass Channel Manning’s n Assessment Memorandum
APPENDIX H	Refined Flood Mitigation Measures Grading Plans
APPENDIX I	Capital Cost Estimates

1 INTRODUCTION

1.1 Project Summary and Report Scope

The City of Brampton (the City) initiated the *Phase 2: Integrated Riverine and Urban Flood Risk Analysis and Urban Design Study* (herein referenced as the *Phase 2* study) to build upon previous studies and to more definitively characterize current flood risks in Downtown Brampton. Potential mitigation strategies are also explored and outlined. The specific area addressed in the study includes Downtown Brampton Special Policy Area #3 (herein referenced as *SPA 3*), which addresses flood potential caused by the nearby Etobicoke Creek during a Regulatory Storm event. The subject area of the *Phase 2* study is expanded where required beyond the SPA 3 boundaries to accommodate technical flood modelling requirements and also to ensure sufficient scope and consideration of urban design elements.

The City's *Phase 2* study process identified from its outset the inextricable links between potential future flood risk mitigation strategies and the City's existing and long term urban design goals. Concurrently, the *Phase 2* study recognizes that the City's urban design goals and strategies have and will continue to be shaped and influenced by physical flood risk realities. Flood modelling tasks and urban design tasks as the two interrelated areas of focus of the *Phase 2* study correspond to Part 1 and Part 2 of the study. SGL Planning & Design Inc. and FORREC Ltd. together led all urban design focused work on the project, identified nominally as Part 2 of the overall study.

This current technical report addresses and is focused on Part 1 study topics which include flood risk identification, technical flood modelling, and exploration of mitigation options. Urban design issues are discussed and cross-referenced within this current Part 1 technical report, but the report scope is decidedly technical and concentrated on flood modelling and risk analysis. The authors of this report are Matrix Solutions Inc. and DHI Canada, who together are responsible for the flood modelling work contained herein. Flood mitigation approaches explored in this report have been completed within the context of urban design, but their discussion is focused on technical results. Specific *Phase 2* study elements related to urban design have been forwarded to the City by SGL and FORREC under separate cover, and contain a significant emphasis on visual and graphical presentation.

The *Phase 2* study expands on the previously completed *Downtown Brampton Flood Protection Feasibility Study* (the previous '*Phase 1*' study; completed by AMEC Foster Wheeler [2016]), and addresses the recommendations for further study and exploration of mitigation options contained therein. One of the main areas of focus that followed for the *Phase 2* study is required analyses of interaction between the City's so-called urban drainage system (consisting of storm sewers and overland flow routes) and the riverine system of Etobicoke Creek. Following recommendations of the 2016 *Phase 1* study, the two systems, urban and riverine, have been analyzed together within a fully integrated hydraulic model created as part of the *Phase 2* study.

The scope and objectives of the *Phase 2* study are outlined as follows:

- Achieve a more complete knowledge of existing flood risk in the study area by developing a 3-way integrated hydraulic model of the Brampton SPA 3 area including urban, riverine, and overland flow components.
- Identify existing urban areas at risk to riverine and/or urban flooding during minor and major storm events.
- Evaluate and refine the *Phase 1* report short-listed flood mitigation alternatives in the context of both urban and riverine flood mitigation using the 3-way integrated hydraulic model.
- Integrate urban design context and thinking, including consideration of land use opportunities, into exploration of all mitigation opportunities and explorations.
- Identify and outline additional mitigation opportunities and strategies that may be revealed through the more comprehensive picture allowed by the *Phase 2* flood risk analysis and the additional technical modelling capabilities made available.
- Outline preliminary technical expectations of potential urban and riverine flood protection and mitigation strategies, thereby allowing initial feasibility to guide future study and assessment.

The *Phase 2* study will also incorporate other ongoing and concurrent studies, initiatives, and policies of the City (e.g., the City's urban design vision) and also those of Toronto and Region Conservation Authority (TRCA).

1.2 Study Area and Overview

The study area is shown on Figure 1 and is centred on the Downtown Brampton SPA 3, including all lands within the Regulatory Storm (Hurricane Hazel) flood hazard limit. Upstream of the existing concrete bypass channel (bypass construction completed in 1952) spill occurs away from the concrete channel and proceeds into the historical river valley that begins at Church Street near Ken Whillans Drive. Spilled flood flow from the river continues overland via streets and properties to the downtown area. Backwater conditions occurring downstream of the confluence of the existing bypass channel and the historical valley in the area of Mary Street and Moore Crescent cause flood waters to proceed significantly past Main Street. Downstream of the concrete channel and natural channel confluence a pinch point occurs in the valley which significantly contributes to the backwater conditions.

The Phase 1 study (AMEC 2016) originally investigated alternatives to mitigate riverine flooding using the one-dimensional HEC-RAS hydraulic model. The study recognized that high flows from Etobicoke Creek also impact minor and major urban drainage systems via the downstream backwater and the upstream spill flow conditions. Thus, due to the urban nature of the spill areas, a new 3-way integrated

model to evaluate flooding in the urban (i.e., storm sewer system), channel/riverine, and overland flow systems was determined as necessary. The overland flow portion of the model represents both floodplain (i.e., the above-bank riverine flows) and also urban-derived flows in within the same two-dimensional (2D) flow format, thereby allowing for interaction of these two flooding flows. The current study through its newly developed 3-way model aims to evaluate, refine, and build upon the previously short-listed flood mitigation alternatives (as provided in the *Phase 1* report) through a more integrated understanding of the different types of flooding processes that occur at this site.

The portion of study area required to be modelled, i.e., the so-called model domain, is large enough to ensure boundary conditions are adequately established and that the study area is suitably represented. To ensure model stability, the 2D domain of the 3-way coupled model is extended to areas that include the Bram East SPA located downstream of SPA 3 on the west bank of the creek (refer to Figure 1). Importantly, no impacts or changes otherwise to the Bram East SPA will result from this current *Phase 2* study or its recommendations. Any variations in flood characteristics within the Bram East SPA are to be considered a result of the different modelling techniques used. The current study is not meant to influence the ongoing study in the Bram East SPA. The City is concurrently undertaking an SPA update process for Bram East; and floodplain characterization of the Bram East SPA will occur through that process.

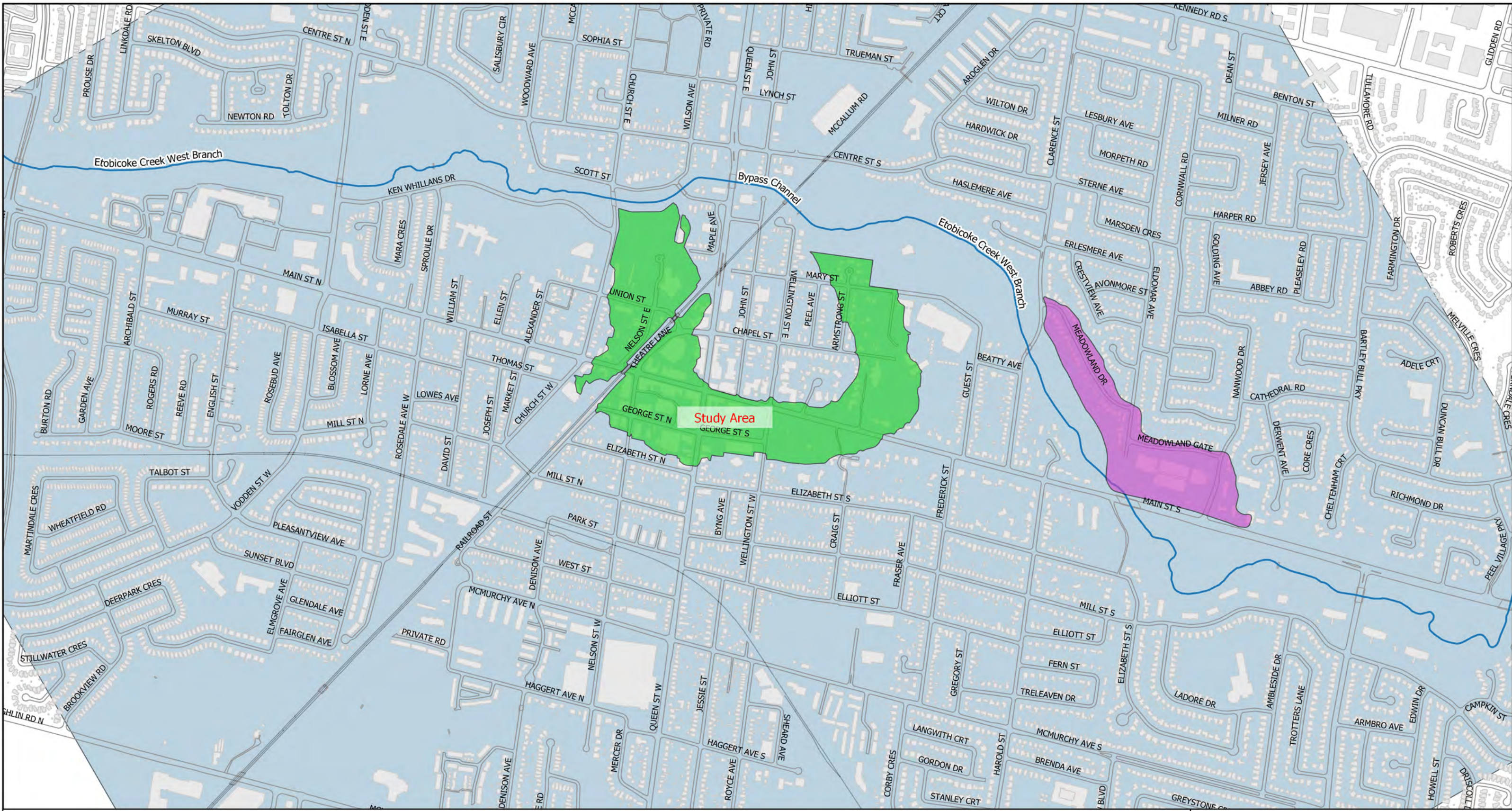

Figure Date: December 15, 2017

Legend

- Watercourse
- Downtown Brampton SPA
- Bram East SPA
- 2D Model Domain



Matrix Solutions Inc.
ENVIRONMENT & ENGINEERING

Brampton Integrated Flood Study
Final Report

Project #22062

Study Area

Disclaimer: The information contained herein may be compiled from numerous third party materials that are subject to periodic change without prior notification. While every effort has been made by Matrix Solutions Inc. to ensure the accuracy of the information presented at the time of publication, Matrix Solutions Inc. assumes no liability for any errors, omissions, or inaccuracies in the third party material.

K. Molnar
K. Hofbauer

Figure 1

2 BACKGROUND REVIEW

2.1 Previous and Ongoing Studies

The following sections summarize the previously completed studies that were reviewed in relation to the project.

2.1.1 Etobicoke Creek Hydrology Update (MMM 2013)

The *Etobicoke Creek Hydrology Update Study* (MMM Group Limited 2013) prepared for the TRCA updated the hydrologic models for the Etobicoke Creek watershed to assess existing and future conditions hydrographs and peak flows. The study also developed a stormwater quantity control strategy for upstream developments to improve flood risk management and mitigate impacts caused by future conditions. The current study area lies within the Etobicoke Creek watershed. The hydrologic models developed through the Etobicoke Creek hydrology update were used in the current study.

Due to improved calibration procedures and data, modelling simulations in the 2013 MMM model predicted significant decreases in Regional flows in the headwaters as compared to previous studies. The TRCA raised concerns about the possibility of underestimating peak flows for the Regional Storm due to limited confidence in flow data at the Brampton and Spring Creek gauges and as a result it was decided that the model would use the uncalibrated T_p (time to peak) and Manning's ' n ' values for areas upstream of those gauges. A review of future land use, future climate change assumptions, as well as resiliency allowances should continue to be revisited in future studies.

2.1.2 Downtown Brampton Drainage Study

2.1.2.1 Part 1 - Flood Risk Assessment (Aquafor 2006)

Part 1 of the Downtown Brampton Drainage Study was completed in 2006 and included a flood risk assessment to refine the Downtown Brampton area of the TRCA's existing HEC-RAS model for Etobicoke Creek, to confirm Regulatory flood lines, and assess flooding depths within the SPA. The current SPA policies refer to Regional Storm and 350-year storm events and therefore an understanding of flood characteristics for both storm events was required. The study reviewed various flood proofing techniques and possible flood relief strategies to address concerns about future development applications in the SPA. The study also included an evaluation of the cost of the mitigation alternative versus the cost of flood damage.

Four flood relief alternatives were identified for consideration: re-design of the bypass channel, larger railway openings, and grading works to create a berm near Church Street and Ken Whillans. The "350-year berm/wedge" strategy to create a berm/wedge near Church Street and Ken Whillans Drive to the 350-year level was identified as the only economical strategy with benefits outweighing costs.

2.1.2.2 Part 2 - Stormwater Management (Aquafor 2008)

Part 2 of the Downtown Brampton Drainage Study made recommendations for stormwater management alternatives under existing and future conditions. The Part 2 study was not intended to address Regional Storm flood issues; rather, it was completed in response to development pressures for intensification in Downtown Brampton to comply with the Provincial Policy Statement promoting redevelopment in existing built up areas. Due to the age of Downtown Brampton, much of the infrastructure was constructed before any stormwater management requirements or standards existed and therefore existing infrastructure does not meet current standards. The study involved monitoring, modelling, and characterizing the existing storm sewer system and identifying future constraints caused by intensification. Stormwater management criteria and practices were also reviewed including recommended stormwater management strategies to be applied at future redevelopment sites. A MIKE URBAN model was prepared to model the storm sewers within the Downtown Brampton area and was calibrated to three rainfall events which occurred in 2007. The model domain for the stormwater management study is contained within the current study model boundary.

2.1.3 Brampton Central Area Sustainable Infrastructure Study Baseline Review (WSP 2014)

The Brampton Central Area sustainability study baseline review focused on assessing the infrastructure required to service future growth and development in the Brampton Central Area. The study looked at hydro, gas, telecommunications, water, wastewater, and stormwater infrastructure systems. One of the recommendations of this study was to complete a detailed storm sewer inventory and model for the City to assist in the analysis of existing storm sewer capacities and identification of constraints. The development of this inventory and model is currently ongoing.

2.1.4 Downtown Brampton Special Policy Area Comprehensive Flood Risk and Management Analysis (City of Brampton 2014a)

The Downtown Brampton SPA comprehensive flood risk and management analysis study provided a review of planning policy and relevant studies and conducted a risk assessment as part of the procedure for approval of modification to existing SPAs. The study proposed amendments to the SPA secondary plan policies, development permit bylaw, and zoning bylaw. The proposed amendments, in combination with the findings of the current project, will guide the future management of the SPA.

2.1.5 Downtown Brampton Etobicoke Creek Revitalization Study

2.1.5.1 Part 1 - Downtown Brampton Flood Protection Feasibility Study (AMEC 2016)

The *Downtown Brampton Flood Protection Feasibility Study*, herein referred to as the *Phase 1* study, developed and evaluated a shortlist of feasible flood mitigation alternatives. These alternatives are aimed to reduce flood risk associated with a Hurricane Hazel type event in the Downtown Brampton SPA. The study included a flood characterization which identified both spill and backwater factors

contributing to the flood conditions within the SPA. The study considered and reviewed a number of alternatives that have the potential to mitigate these flood conditions. Both permanent and non-permanent alternatives were considered and included the following:

- Combination 1: Ellen Street Flood Protection Landform (FPL) + Church Street Bridge Improvements + Widen Bypass Channel through Church Street Bridge
- Combination 2: Ellen Street FPL + Lower Bypass Channel
- Tailwater FPL near Moore Crescent

The study conclusions recognized the limitations of the completed 1D hydraulic modelling and recommended that future work be completed to incorporate 2D hydraulic modelling. This recommendation provided much of the impetus for the approach taken in the current *Phase 2* study. It is noted here that the current *Phase 2* study expands upon the recommended flood mitigation strategies outlined in the *Phase 1* study.

2.1.5.2 Part 2 - Urban Design & Land Use Study (City of Brampton 2014b)

The urban design and land use study evaluated each combination of mitigation measures identified in Part 1 from an urban design perspective looking at neighbourhood impact, potential to remove the SPA designation from Downtown Brampton, and the application of urban design principles for revitalization of Etobicoke Creek through Downtown Brampton. Master Plan concepts and costs estimates were completed for the identified mitigation alternatives. It is noted that Part 2 of the current *Phase 2* study (under separate cover and completed by SGL Planning and FORREC) expands upon the urban design concepts presented in the 2014 study.

2.1.6 Downtown Brampton Floodplain Mapping Update (Valdor 2017)

Valdor Engineering prepared the Downtown Brampton Floodplain Mapping Update for the TRCA. The study area focused on Downtown Brampton in and around the Downtown Brampton Flood Damage Centre (FDC) and SPA. Valdor developed a new HEC-RAS model for the study area using LiDAR, watercourse survey and as-built information to define model geometry. Flow values from the Etobicoke Creek Hydrology Update (MMM 2013) were used. The study's predicted interaction between the bypass channel and Downtown Brampton FDC indicated that 24% of the total Regional flow spills into the FDC. In general the modelling results produced similar flooding extents as previously predicted by Greck and Associates (2012) when this latter Greck study considered lower flows. Floodplain map sheets for the Regional and 350-year storms were created by Valdor, and these revised maps replaced existing floodplain mapping within the study area. The updated HEC-RAS model from the Valdor 2017 study was used as the base model in the current *Phase 2* study.

2.1.7 Waste Delineation and Characterization Report, Centennial Park and Centre Park Landfill Areas (WSP 2018)

WSP Canada Inc. (WSP) completed investigations of the historical Centennial Park and Centre Street landfill sites for the City. These sites are located within the Etobicoke Creek valley, immediately on each side of the creek channel and at a point just downstream of the existing concrete bypass channel. The WSP investigation was commissioned to support the ongoing flood remediation studies in the area. A geophysical survey (electromagnetic) at each of the landfill sites was conducted to delineate the approximate limit of buried landfill materials. A subsurface investigation was then completed by WSP consisting of 11 boreholes at the Centennial Park site and 8 boreholes at the Centre Street site. Three boreholes within each site were completed as groundwater monitoring wells.

At the Centennial Park site refuse/waste was encountered in nine (9) of the eleven (11) boreholes. Refuse was encountered to a maximum depth of 6.10 m below ground surface (bgs). Generally, the refuse encountered included ash, coal, brick, glass fragments, wood, paper, plastic and some metal. At the Centre Street site waste was encountered in all eight (8) boreholes. Refuse was encountered here to a maximum depth of 6.10 m bgs. Generally, the refuse encountered included paper, wood, brick, glass fragments, plastic, metal, and minor amounts of asphalt, coal and ash. To support the evaluation of alternatives within the current study, WSP calculated the landfill volumes and associated costs for removal, delineated to suit the identified flood mitigation alternatives.

2.2 Data Collection and Preparation

Matrix reviewed all available data and design information as part of the background review. Additional data processing was completed on the minor system (i.e., storm sewer system) to fill remaining data gaps and prepare the data for model use. Further study area knowledge was also obtained from a site walk led by the City in August 2016.

2.2.1 Data Acquisition

A record of received data is located in Appendix A. As illustrated in the tables in Appendix A, all requested GIS and topographic information was obtained. Where available, meteorological and streamflow data, storm sewer data, sanitary sewer data, and groundwater data was obtained.

2.2.2 Minor System Invert Data

On July 14, 2016, the City provided Matrix with the sewer network shape files for the City. The storm sewer network data was reviewed and a data gap analysis was performed. Data gaps were identified in the City's sewer network that proved critical to the full development of the model. While most of the sewers included size and slope information, invert elevations of the sewers were not available. It was decided that detailed survey of each manhole within the study area was not feasible within the scope and schedule of the current study.

2.2.2.1 Manhole Survey Selection Criteria

While inverts are needed for all pipes in the model for it to run, there are several key locations where it is critical to have the actual elevation to achieve useful model output. A scoped field survey was therefore developed based on understanding these key location requirements. For other areas, where sections of pipe are relatively continuous with little change, sewer inverts were estimated from upstream or downstream pipes based on slope. Areas critical for survey include:

- sewer outlets
- manholes located at main sewer intersections
- major changes in pipe size
- areas of concern

Areas of concern include areas where there is a lack of data or verification is needed around the pipe network. This is particularly of interest in the SPA.

The detailed listing of manholes identified for survey is included in Appendix B (*Selection/Identification Priority of Manholes for Surveying for Integrated Flood Risk Model Development*, Matrix September 2016).

2.2.2.2 Invert Data from Downtown Drainage Study Model

Matrix reviewed the existing MOUSE model developed for the Downtown Drainage Study (DDS, Aquafor 2008) located within the study area which contains sewer inverts from City design drawings. The City indicated that a detailed review of the previous study for quality control of the invert data has not been completed and therefore the scoped survey included the sewer inverts within the study area rather than relying directly on historical design drawings or the DDS model. Matrix used the critical locations to verify the elevations used in the DDS model. Pipe invert elevations measured during the survey were compared to the DDS model as a quality control check on the previous model. There was good consistency between the measured inverts and those contained in the previously developed model, and therefore the invert data from the previous model was deemed acceptable for use in this current *Phase 2* study. Additional sewer inverts contained within the DDS model were then applied where they were available. Where this was not applicable or where the DDS model was not in sufficient agreement with the surveyed elevations, Matrix interpolated sewer elevations between the surveyed locations as detailed in Section 2.2.2.3.

2.2.2.3 Invert Data Filling

Following the review of available invert data from survey and the DDS model, a process was developed for infilling invert data for the MIKE URBAN model. A detailed description of the process used for infilling data gaps is included in Appendix C (*Infilling Sewer Data from Manholes Survey for Integrated Flood Risk Model Development*, Matrix February 2017).

Following a hierarchical process (i.e., if Option 1 is suitable then proceed with it; if not then proceed to Option 2, etc.), the following methodology was used for infilling pipe data:

1. Use survey data where it exists and where there is confidence in the survey data.
2. Use inverts from the DDS model in areas within the DDS study area.
3. Use two surveyed inverts where possible to determine average pipe slope over a length of sewer runs.
 - calculate missing inverts based on pipe slope between the surveyed points
4. Assume pipe slope based on ground slope where only one survey invert is available
 - calculate missing inverts upstream or downstream of known invert based on ground slope
 - in some cases this had to be divided into smaller lengths due to variations in ground slope
5. Assume 0.2% pipe slope in rare case where ground slope did not match pipe flow direction such as reverse graded pipes. This typically only occurred at upstream extents of the system.
6. Make exceptions on a case by case basis to ensure:
 - acceptable level of cover
 - appropriate slope
 - reconcile differences in survey, City GIS layer pipe sizes, and DDS model

2.2.2.4 Spatial Processing

Several spatial processing tasks were conducted on the datasets to prepare them for use within the MIKE URBAN model. These tasks included the following:

- linking to/from manhole IDs to the storm sewer lines
- linking catch basins to the nearest upstream manhole
- determining outlets and assigning an outfall ID field to the storm sewers

Storm sewer connections were traced upstream from the outlets to determine the full extent of the minor drainage system to be included in the MIKE URBAN model.

2.2.3 Site Walk

On August 4, 2016, Matrix joined the City, TRCA, Danish Hydraulic Institute (DHI), SGL Planning & Design Inc., and FORREC Limited for a site walk of the study area. This site visit was led by a representative of the City. The site walk served to gain more background knowledge through observations and discussions of key areas of interest within the study area.

Figure 2 outlines the route walked. Knowledge gained through the site walk is summarized below.

Key observations included the following:

- bypass channel location and cross-section
- drop structure
- historical retaining walls
- gabion walls
- historical channel location
- woodlot

Main points of discussion included the following:

- properties restricting design changes
- proposed *Phase 1* landform locations
- proposed extents of *Phase 1* lowered channel
- discussion of conditions under flooding
 - ✦ upstream no issues
 - ✦ 2013 flood levels were slightly below bridge soffits

Photographs taken during the site walk are located in Appendix D.

3 EXISTING CONDITIONS MODEL DEVELOPMENT

DHI prepared the existing conditions model using background data compiled by Matrix. The model includes three components: the one-dimensional (1D) urban component including hydrologic catchments and the hydraulic system (catch basins and sewers); the 1D riverine component (including inflows from upstream areas); and the two-dimensional (2D) overland component. The following sections summarize the preparation of each of these components.

3.1 1D Urban Model Development

The development of the 1D urban component was completed using MIKE URBAN and includes the following steps:

- delineate and import urban catchments and assign appropriate hydrologic parameters
- compile and import sewer network data (catch basins, manholes, pipes, and outlets)
- connect catchments to sewer network
- assign boundary conditions at outfalls

A schematic of the MIKE URBAN model input data is provided in Figure 3 including land use, catchments, catch basins, manholes, and sewers.

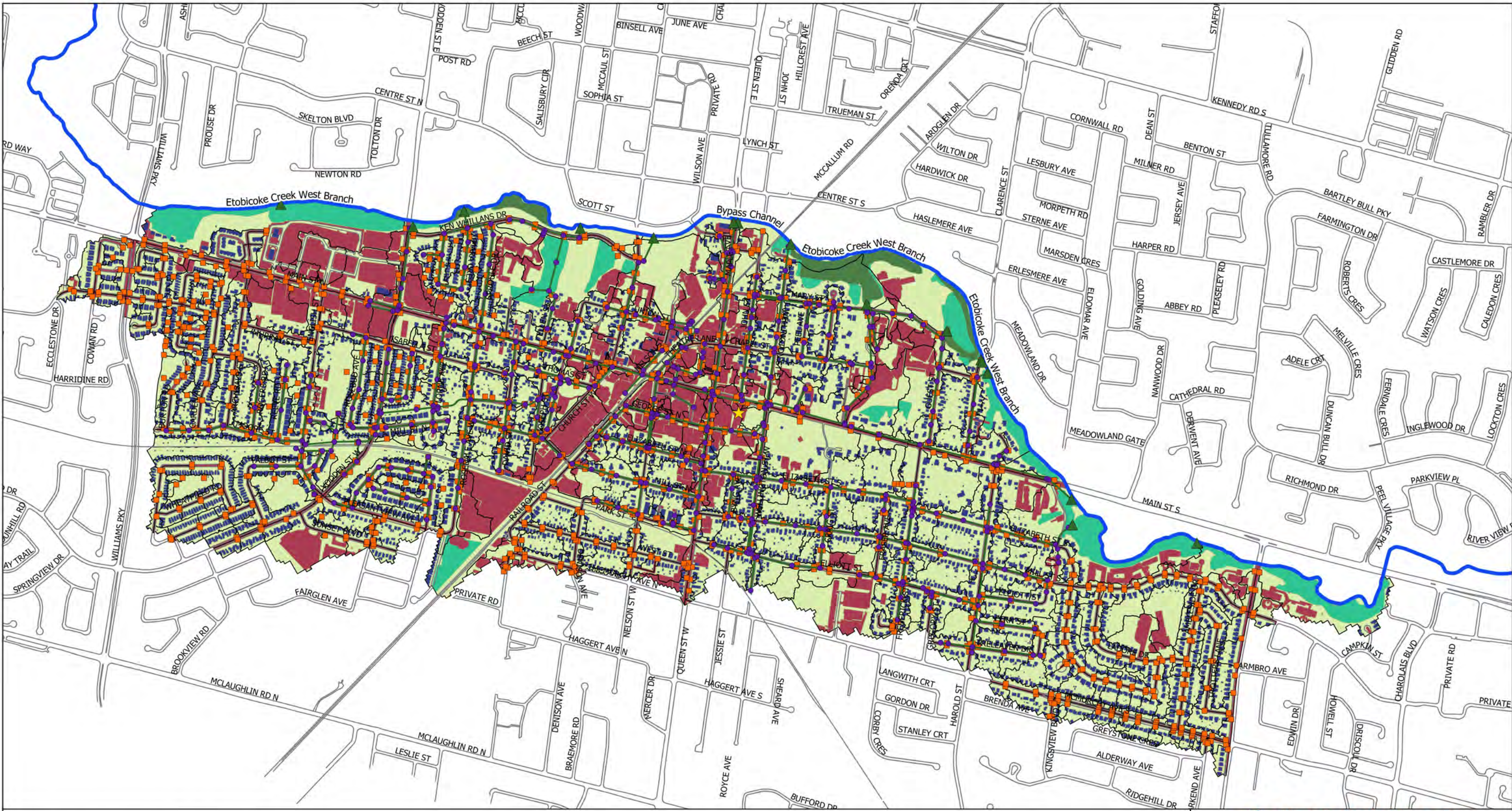
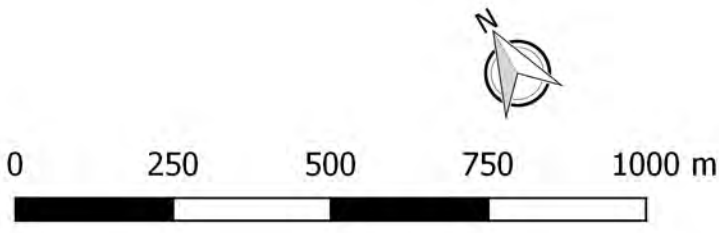

Figure Date: January 3, 2018

Legend

- | | | |
|-------------|------------|------------------|
| Watercourse | Sewer | Impervious Flat |
| Catchments | Outlet | Impervious Steep |
| Manhole | Rain Gauge | Urban Pervious |
| Catchbasin | | Natural |
| | | Woodlot |



Brampton Integrated Flood Study
Final Report

Project #22062

1D Urban Model Schematic

Disclaimer: The information contained herein may be compiled from numerous third party materials that are subject to periodic change without prior notification. While every effort has been made by Matrix Solutions Inc. to ensure the accuracy of the information presented at the time of publication, Matrix Solutions Inc. assumes no liability for any errors, omissions, or inaccuracies in the third party material.

K. Molnar
K. Hofbauer

Figure 3

3.1.1 Urban Catchments

3.1.1.1 Catchment Delineation

Catchments were delineated at a catch basin scale based on the procedure described by the Massachusetts Metropolitan Area Planning Council (MAPC 2015). The catchment areas were delineated using the LiDAR DEM surface and a set of hydrology analysis tools in ArcGIS used to process the data sets. The GIS data used in this process included storm sewer pipes, catch basins, outfall locations, street centrelines, and property parcels. A series of spatial analysis steps were taken to associate each catch basin with the outfall feature to which it contributes flow. Then the DEM was enhanced using the street centreline and property parcel lines at the edge of the roads to ensure that flow runs from street crowns and properties into the street gutters to better model the drainage patterns that the raw DEM may not precisely capture on its own. Where necessary, manual adjustments were made to the catchment boundaries to refine the automated process based on site-specific knowledge (e.g., to match Etobicoke Creek study boundary, site drainage on large commercial properties, or clip at road, etc.).

Catchments were delineated to each catch basin thereby determining the drainage area contributing to each pipe segment. Where runoff is captured by sewers leading outside of the model domain, the flows were allowed to outlet from the model as appropriate. Other areas along the banks of the river are not associated with a catch basin and thus were connected directly into the river.

The study area domain included urban catchments north and south of SPA 3 which are not hydraulically connected to the Downtown Brampton sewer network. These catchments were kept in the MIKE URBAN model to account for the runoff contribution to Etobicoke Creek. The pipes associated with these areas were not included in the model; the catchments outlet directly to the creek. Instead, two separate 'dummy pipes' were created to direct runoff from these disconnected catchments to Etobicoke Creek. These pipes were artificially sized to convey runoff from large storm events to the creek without surcharging at the dummy manhole.

3.1.1.2 Catchment Hydrologic Parameters

Each catchment was assigned hydrologic attributes including: percent impervious area, percent pervious area, catchment length, catchment slope, and roughness (Manning's n). The catchments were each subdivided into pervious and impervious land use types consistent with MIKE URBAN modelling practice as follows:

- Pervious areas were split into three categories based on the land use classification: woodlot areas, other natural/floodplain areas, and pervious urban areas (i.e., lawns, parks, etc.).
- Impervious areas were classified as either steep (small buildings/residential roofs) or flat (other highly urban areas such as large buildings, parking lots, roads, etc.).

Catchment lengths were determined using the impervious area overland flow length equation, as presented in the Visual OTTHYMO (VO) v3.0, *User's Guide* (Civica 2013):

$$Length = \sqrt{\frac{Area}{1.5}}$$

The mean slope for each catchment was calculated from the DEM.

Manning's n values for the urban catchments were assigned based on land use types grouped by categories defined by the *Standard Manning's Roughness Coefficients for TRCA Watershed Hydraulic Modelling* (TRCA n.d.) which are summarized in Table 1.

Table 1 Urban Catchment Pervious and Impervious, Land Use Type, and Manning's n

Pervious Type	Land Use Type	Manning's n
Pervious	Urban Uses (Pervious)	0.050
Impervious	Urban Uses (Impervious) - buildings, roads, parking lots, other urban land use	0.025

No information was available regarding individual stormwater management plans within the study area. Due to the age of the development in this area and a review of the aerial photos we assumed that no stormwater management quantity controls exist in the study area and therefore none were included in the MIKE URBAN model.

3.1.2 Sewer Network

The storm sewer network (catch basins, manholes, pipes, and outlets) was provided by the City in GIS format. The shapefiles contained most of the required attributes for the manholes (X-coordinate, Y-coordinate, ground level) and pipes (from node, to node, length, shape, diameter, height, width, and material). A detailed discussion on data gap filling within the sewer network data is presented in Section 2.2.

3.1.2.1 Pipes

The GIS pipe network provided by the City included pipe location, size, and material. The Manning's roughness was applied to each pipe based on identified material and is consistent with standard practice (i.e., Manning's n = 0.013 for concrete). Pipe lengths were extracted directly from the shapefile geometry. Connectivity to upstream and downstream manholes was completed through georeferencing. A field survey of selected manhole locations was conducted by the City and sewer inverts were filled in as detailed in Section 2.2.2.2.

3.1.2.2 Manholes and Catch Basins

The manhole (MH) and catch basin (CB) locations were imported to MIKE URBAN from the shapefiles provided by the City. Manhole rim and CB lid elevations were assumed equal to ground surface elevation as provided in the LiDAR-based DEM. Manhole invert elevations were assumed based on the lowest connecting pipe invert elevation at each manhole. Additional manholes were added to the model as required to enable changes in pipe size or direction. CB outlet pipe inverts were calculated based on lid elevations and assuming a depth of 1.2 m to invert below.

Generally, manhole diameters were assumed to be 1 m, except where the diameter of a connecting pipe was larger. In these cases the diameter of the manhole was assumed to be equivalent to the diameter of the downstream pipe.

3.1.2.3 Catchment Connections

As discussed in Section 3.1.1.1 catchments were delineated to each CB. Using the previously created association, the catchments were then connected directly to the appropriate CB using the CB ID as a matching criterion. This process connected the majority of catchments to their associated CB in the model with the exception of eight (8) coincident catch basin manhole (CBMH) structures as presented in Table 2. These CBMHs had IDs corresponding to the manhole and as such the catchments were manually connected to the appropriate node as indicated in Table 2.

Table 2 Coincident Catch Basins and Manholes

MH ID	CB ID
MH_7	CB_44453
MH_16	CB_34637
MH_29	CB_19558
MH_34	CB_59620
MH_38	CB_13212
MH_39	CB_13261
MH_40	CB_10500
MH_46	CB_45035

Once the catchments were connected to their associated CBs, the CBs were connected to the manholes to convey runoff at the appropriate rate into the storm sewer network. A shapefile of the CB leads was not available; however, the City of Brampton *Subdivision Design Manual* (2008) specifies that a single CB is to be connected to a manhole with a 200 mm pipe. At this stage in the study we assumed that all CBs in the study area are single catch basins and, hence, all CB leads consist of a 200 mm diameter pipe.

While the model is capable of representing the CB leads using a pipe feature, this has the potential to cause numerical instabilities as it would create many pipes with a short length. In order to avoid such numerical instabilities the CB leads were represented using an orifice feature rather than a pipe feature. The orifice parameters were assigned such that they account for appropriate pipe losses expected to

occur through the assumed 200 mm pipes and include a circular orifice with a diameter of 0.25 m and a discharge coefficient of 0.85. A number of trial scenarios were completed to arrive at these parameters, which is discussed in detail in the *2D Urban Flood Model Development* memorandum (DHI 2017).

The connection of the CBs to the manholes was completed using the MIKE URBAN Auto Connection Tool to automatically generate an orifice between CB nodes and the nearest manhole nodes. The orifice crests were set 0.1 m above the CB inverts, which aligns with the assumption that all CBs were assumed to be 1.2 m deep. In a few cases where the orifice crest ended up being lower than the manhole invert the crest elevation was set 0.01 m above the connected manhole invert.

3.1.3 Urban Model Boundary Conditions

The MIKE URBAN model boundary conditions include rainfall applied to the catchments as well as water levels at the outlets. Note that the outlet water level boundary conditions are only required when MIKE URBAN is run as a standalone model. The MIKE 11 water elevations are used as downstream boundary conditions in MIKE URBAN when the 3-way integrated model is implemented.

3.1.3.1 Rainfall

The MIKE URBAN inflow boundary conditions consist of applying a rainfall intensity time series onto the catchments and then using the MIKE URBAN rainfall runoff module to calculate the rate of runoff from each catchment. In MIKE URBAN the rainfall boundary condition is referred to as a Catchment Load boundary condition. Since the study area is relatively small and there is only one nearby rainfall measurement station for use in calibration (refer to Figure 3), a single rainfall time series was applied to all catchments (i.e., there is only one Catchment Load applied to all catchments and is associated to a single rainfall intensity time series).

The rainfall time series' generated for the MIKE URBAN model for this study included the 2-, 5-, 10-, 25-, 50-, 100-, and 350-year design storms using the 12-hour AES rainfall distribution. The 12-hour AES was selected following the hydrology model review which revealed that this storm distribution provides the most conservative estimate of peak flows in the riverine system. Additional assessments using the 10-year and 100-year design storms based on the 3-hour Chicago rainfall distribution were completed since this is the City's design standard and as such all new systems in the study area would be designed based on this rainfall distribution. In addition, the 3-hour Chicago rainfall distribution is typically used to generate peak flows in urban areas where flows are largely influenced by rainfall intensity as opposed to rainfall depth. The Chicago rainfall distribution provides much higher peak intensities compared to the AES distribution and therefore would likely produce more realistic flooding results in the urban system. The 10-year and 100-year design storms were selected for this additional assessment as these are typical design events for the minor and major stormwater system components, respectively.

3.1.3.2 Outfalls

The stormwater outfalls along the creek were set as free flow outlets in the MIKE URBAN model. This assumption is only required while the MIKE URBAN model is run in standalone format prior to coupling with the riverine system. When fully integrated, the hydraulic head simulated in the riverine model will inform the outflow boundary on the urban model.

3.1.4 1D Urban Simulation Settings

The simulation settings applied in the MIKE URBAN model include the following:

- Runoff Parameters
 - ✦ Model type: Kinematic Wave (B)
 - ✦ Time Step: 10 seconds
- Network Parameters
 - ✦ Model type: Dynamic Wave
 - ✦ Minimum Time Step: 1 seconds
 - ✦ Maximum Time Step: 5 seconds
- Results
 - ✦ Storing Frequency: 5 minutes
 - ✦ Items: Nodes, Links

3.2 1D Riverine Model Development

The development of the 1D riverine component was completed in MIKE 11 and included the following:

- define channel geometry (centreline, cross-sections)
- define channel roughness (Manning's n)
- insert hydraulic structures
- assign boundary conditions

A schematic of the MIKE 11 1D riverine model setup is provided in Figure 4 including the river centreline, cross-sections, flow input locations, and boundary conditions.

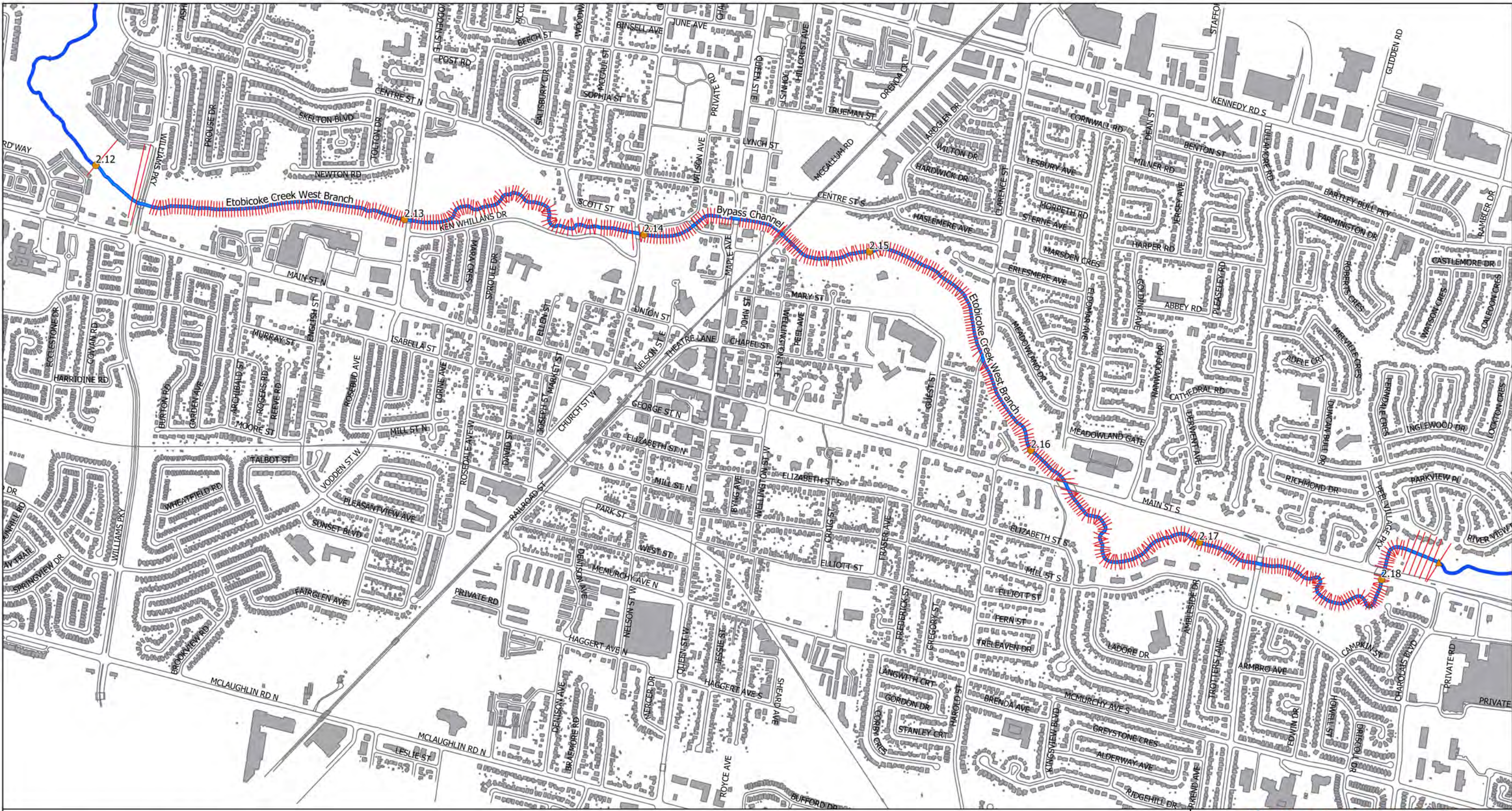

Figure Date: January 3, 2018

Legend

- Watercourse
- River Centerline
- - - Cross-Sections
- Flow Input Location
- ▲ Downstream Boundary Condition



0 250 500 750 1000 m



Brampton Integrated Flood Study
Final Report

Project #22062

1D Riverine Model Schematic

Disclaimer: The information contained herein may be compiled from numerous third party materials that are subject to periodic change without prior notification. While every effort has been made by Matrix Solutions Inc. to ensure the accuracy of the information presented at the time of publication, Matrix Solutions Inc. assumes no liability for any errors, omissions, or inaccuracies in the third party material.

K. Molnar
K. Hofbauer

Figure 4

3.2.1 Riverine Catchments

The existing catchments from the hydrology model were used to provide inflows to the study area to complement the delineated catchments described in Section 3.1.1.1. To appropriately determine the inflow to the study area (and not double count flow within the study area), Etobicoke Creek catchments within the current MIKE URBAN model boundary were removed, as this area is represented by the CB level catchments developed for the MIKE URBAN model. Since the catchments provided by the hydrology study spanned both sides of the creek, the original catchments were first divided along the watercourse and at the study area boundaries, as applicable, to ensure breakdown of the catchments did not affect the calibration of the MIKE URBAN model. Following this confirmation, the catchment portions inside of the study area were removed. The VO catchments within the study area will be replaced with the smaller catchments modelled in MIKE URBAN and described in Section 3.1.1.1.

The proposed study area model was compared to the catchments from the Etobicoke Creek hydrology model which revealed that the residential area within and northwest of Burton Park (included in the Etobicoke Creek hydrology model) actually drains to Fletcher's Creek. A review of the LiDAR and a site investigation confirmed that the 37 ha area drains to Fletchers Creek through a 1 m deep drainage ditch along the south side of Burton Park and, thus, was removed from the hydrologic inputs to MIKE URBAN for this study. Further, it is recommended that TRCA remove this area from the Little Etobicoke hydrologic model in future updates. This assessment is further documented in Appendix E (*Catchment Drainage to Fletcher's Creek at Burton Park*, Matrix November 2016).

3.2.2 Channel Geometry

The channel geometry including river centreline was prepared using available GIS data and the LiDAR-based DEM, as described in the following sections.

3.2.2.1 River Centreline

The river centreline shapefile provided by the City was imported to the MIKE 11 model to generate the river reach. The MIKE 11 model covers a distance of 5.7 km and extends from approximately 200 m upstream of Williams Parkway (HEC-RAS station 26.87) southerly to 250 m downstream of Main Street (HEC-RAS station 26.10). The extent of the model was extended far enough beyond the study area to ensure boundary conditions will not impact flood results in the area of interest.

3.2.2.2 Cross-sections

Channel cross-sections were cut in MIKE 11 using the LiDAR-based DEM. The cross-section spacing of the existing HEC-RAS model was approximately 40 m to 50 m; however, this was considered too coarse for the MIKE FLOOD modelling as the proposed grid size for the 2D model is 2 m resolution and therefore increased accuracy is required to capture bank overtopping to the 2D model. Therefore, cross-sections were cut at 10 m intervals along the river reach to provide more refined spacing between cross-sections. The cross-sections were cut using the DHI MIKE HYDRO Tool. The extracted cross-sections were then

trimmed to the top of bank to allow the 1D channelized flow to be calculated by MIKE 11 while the overbank flows will be calculated by the 2D MIKE 21 overland flow model (refer to Section 3.3.1.2 for details). The cross-sections at the inflow boundary and downstream boundary locations were maintained at full width to accommodate boundary conditions. An example of full and trimmed cross-section is provided in Figure 5.

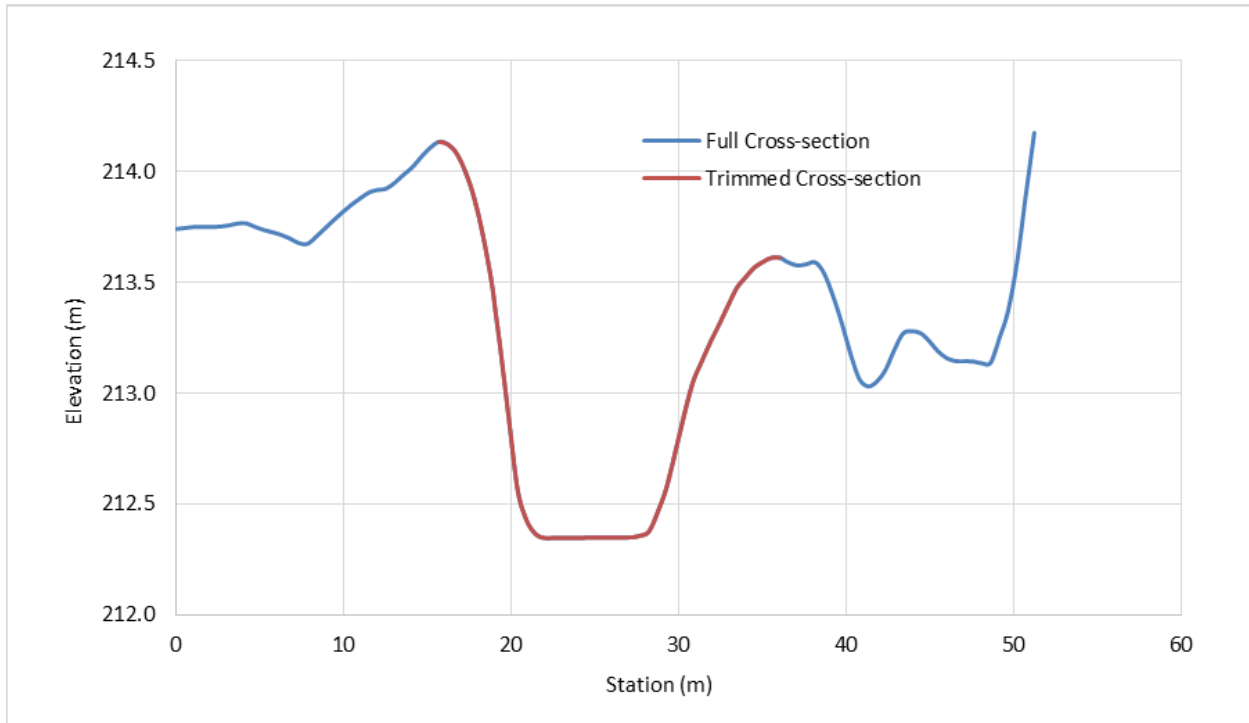

Figure 5 Comparison of Full Cross-Section and Trimmed Cross-Section

Cross-Section Geometry Comparison

The channel cross-sections surveyed by AMEC Foster Wheeler as part of the Downtown Brampton Flood Protection Feasibility Study were compared to cross-sections cut from the LiDAR to determine the best cross-section data for use in the riverine portion of the model within the concrete bypass channel. Figure 6 shows close correlation between the cross-section data except for the low flow channel. Considering that the hydrology study's event flow hydrographs do not include baseflow and that baseflow fills the low flow channel, there is minimal impact in not detailing the low flow channel in the cross-sections. Thus, the cross-sections developed from the LiDAR were selected for use for the MIKE 11 modelling portion of this study. This method is consistent with typical practice elsewhere in TRCA's jurisdiction where the low flow channel represents a very small portion of the valley corridor. Further, using this method produces slightly more conservative results. Inclusion of the low flow channel in hydraulic modelling may be required in future studies, particularly for fluvial geomorphic studies and detailed design projects.

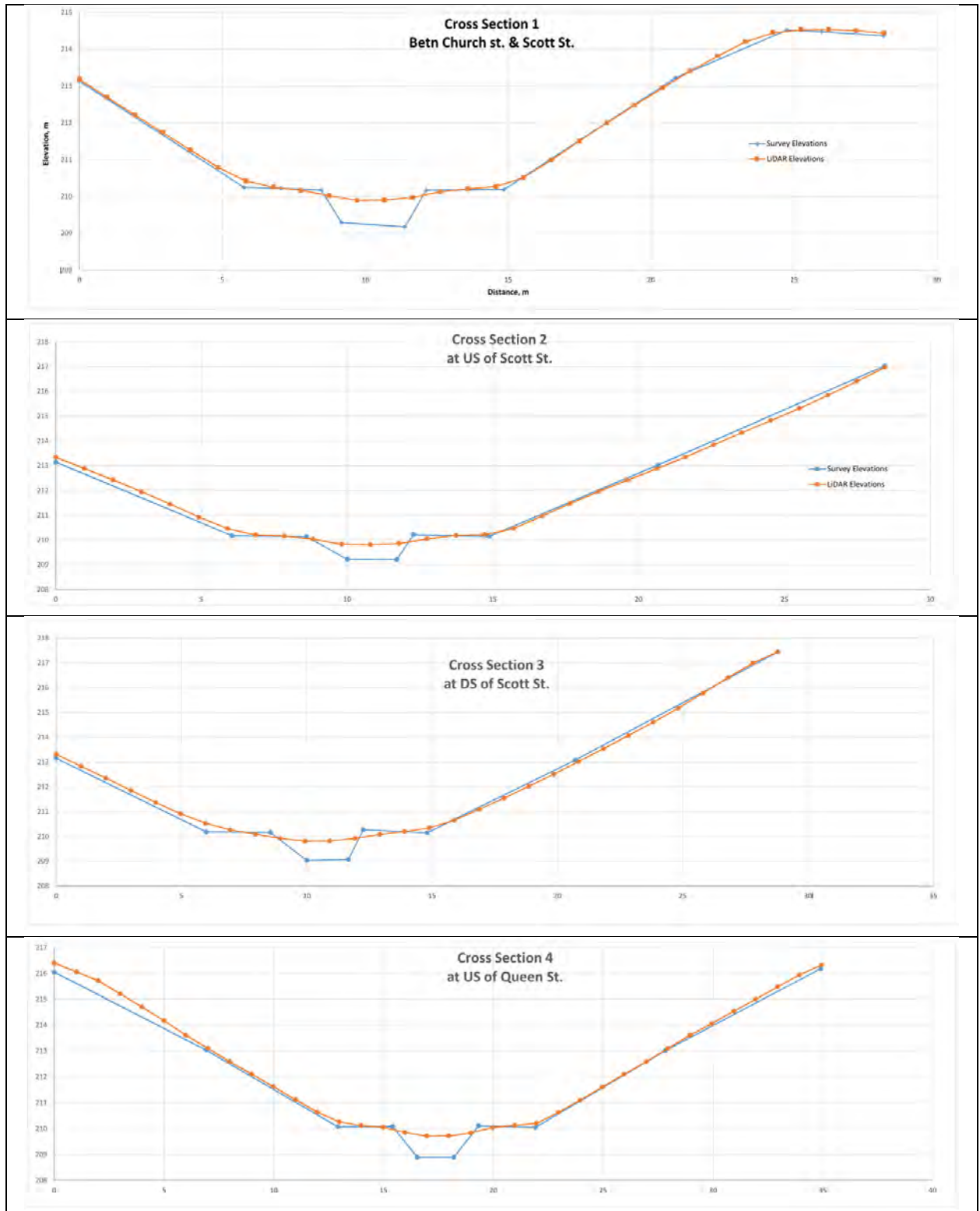

Figure 6 Cross-Section Comparison, LiDAR vs. Survey (Image Credit: TRCA)

3.2.3 Channel Roughness

The Manning's n values along each cross-section were assigned in accordance with TRCA standards as detailed in Table 3. In addition to the values provided in Table 3, the concrete bypass channel was assigned a Manning's n of 0.013.

Table 3 Cross-Section Manning's n Values

Land Use	Description	Manning's n
Watercourse/Channel	<ul style="list-style-type: none"> • Low flow channel • Extends typically from bank to bank 	0.035
Floodplain – Urban Uses (Pervious)	<ul style="list-style-type: none"> • Municipal parks, playing fields, etc. • Typically located within valley and stream corridors • Assumes regular maintenance 	0.050
Floodplain – Natural Areas	<ul style="list-style-type: none"> • Pasture, meadow, riparian vegetation, brush, and forest • Located within urban and/or rural land use setting • Not subject to regular maintenance • Assumes regeneration of open space type uses including pasture, meadow, and agricultural within floodplain areas 	0.080

3.2.4 Structures

There are a total of 11 bridges within the extent of the MIKE 11 model. These are summarized in Table 4. The bridge geometry was obtained from the existing HEC-RAS model (Greck 2010). Following standard practice for MIKE 11 modelling, the bridges were represented as a combination of a culvert and weir at the same chainage. An example schematic of the bridge modelling methodology with culvert and weir representation is provided in Figure 7.

Table 4 Bridge Data

Bridge Name	HEC-RAS Station	MIKE 11 Chainage (m)
EC 25-1R Williams Parkway	26.845	2395.52
EC 24-5R Vodden Street	26.795	3304.92
EC 24-4R Church Street E	26.735	4195.78
EC 24-3R Scott Street	26.695	4399.75
EC 24-2R Queen Street E	26.655	4553.61
EC 24-1RR CNR Tracks	26.615	4719.73
Pedestrian Bridge	26.372	4768.00
EC 23-4R Clarence Street	26.306	5634.86
EC 23-3R Main Street (crossing 1)	26.245	6164.16
EC 23-2R Elgin Drive	26.175	7053.20
EC 23-1R Main Street (crossing 2)	26.125	7663.89

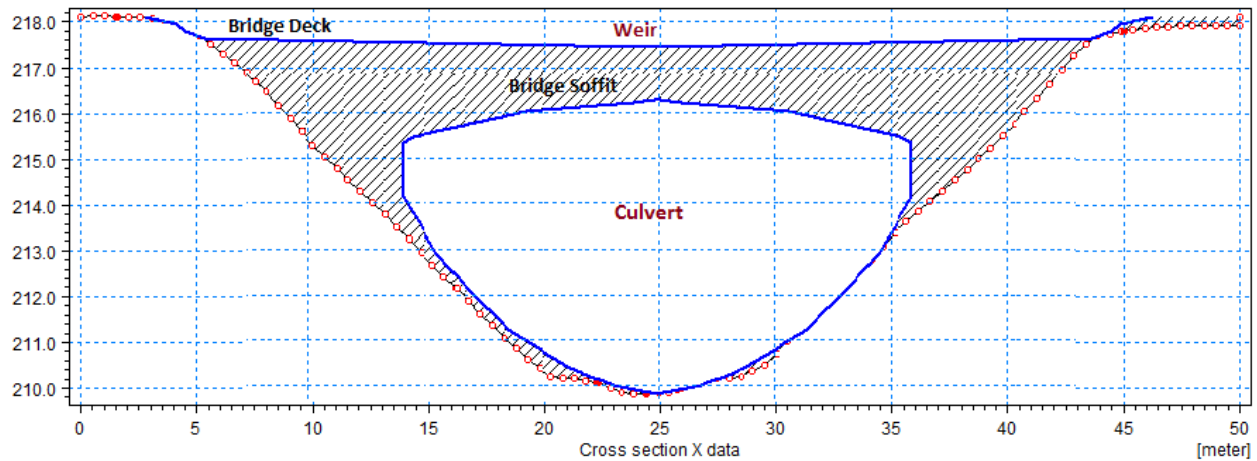

Figure 7 Bridge Modelling Schematic with Combined Culvert and Weir

3.2.5 Riverine Model Boundary Conditions

Boundary conditions for the riverine model include inflows at the upstream end and at intermediate locations along the river reach and water level rating curves at the downstream end of the model. The flow input and boundary condition locations are shown on Figure 4.

A summary of the boundary conditions is provided in Table 5. The boundary condition types are described as follows:

- Inflow – Open: defined at the upstream end of the model to provide inflow to the 1D model
- Inflow – Point Source: defined at intermediate locations as input hydrographs to account for subcatchment discharge to a point along the river branch defined by the chainage
- Q-h Rating Curve: defined at the downstream end of the model to control downstream water elevations (refer to Section 3.2.5.2)

Table 5 MIKE 11 Boundary Conditions

Flow Node ID	MIKE 11 Chainage (m)	Boundary Condition Type
2.12	2188.413	Inflow – Open
2.13	3288	Inflow – Point Source
2.14	4184	Inflow – Point Source
2.15	5048	Inflow – Point Source
2.16	5998	Inflow – Point Source
2.17	6838	Inflow – Point Source
2.18	7638	Inflow – Point Source
-	7918.452	Q-h Rating Curve

3.2.5.1 Inflow Hydrographs

The upstream inflow hydrographs were developed from Visual OTTHYMO at VO ID 1165. Point source inflow hydrographs were also incorporated at intermediate locations along the river to account for runoff from catchments not included in the MIKE URBAN model (i.e., along the east side of the river as well as upstream and downstream of the MIKE URBAN model extent). The MIKE FLOOD modelling uses flows based on existing land use conditions as they were more conservative than future conditions. This is different than what was used in the HEC-RAS modelling (Valdor 2017). Refer to Table 6 for the various flow values.

Table 6 MIKE 11 Peak Flows

TRCA Flow Node	VO ID ¹	MIKE 11 Chainage	Peak Flow (m ³ /s)							
			2-yr	5-yr	10-yr	25-yr	50-yr	100-yr	350-yr	Regional ²
2.12	1165	2188.413	25.9	37.2	45.8	56.5	64.5	72.7	108.1	291.9
2.13	11165	3288	2.4	3.3	3.9	4.7	5.2	5.8	7.7	7.8
2.14	1383	4184	1.8	82.5	3.0	3.6	4.1	4.6	6.2	6.4
2.15	11720	5048	1.0	1.5	1.7	2.1	2.4	2.7	1.1	4.2
2.16	11394	5998	0.5	0.7	0.8	1.0	1.1	1.3	1.7	2.1
2.17	1221	6838	1.8	2.4	2.9	3.4	3.8	4.2	5.6	6.4
2.18	1233	7638	0.5	0.7	0.8	1.0	1.1	1.2	1.6	1.7

Notes:

1. Some of the catchments in the original VO model spanned both sides of the creek. To avoid double counting flow in the urban and riverine systems, these catchments were split along the river and at the study area boundary. Therefore, the VO IDs provided do not necessarily match the original VO model.
2. Based on areal reduction factor of 0.935

The riverine inflow hydrographs were developed for the 2-year through 350-year design storms based on the 12-hour AES rainfall distribution. The 12-hour AES was selected following the hydrology model review which revealed that this storm distribution provides the most conservative estimate of peak flows in the riverine system. Hydrographs were also developed for the Regional Storm event (Hurricane Hazel).

The 350-year design storm and the Regional Storm were run in both steady state and unsteady state conditions. The unsteady state hydrographs were prepared as typical hydrographs with a rising limb, peak flow, and falling limb over the selected storm duration. The steady state inflows were prepared as 'quasi-steady' whereby the flow was gradually increased over a one hour period to achieve stability. The peak flow was then held constant for the remainder of the simulation time (dependent on design storm) to achieve steady state throughout the study area.

3.2.5.2 Downstream Rating Curve

The downstream boundary condition consists of a flow-depth (Q-h) rating curve applied at the outlet of the MIKE 11 model. The rating curve was extracted from the existing condition HEC-RAS model (Greck 2010) at river station 26.10 (as shown on Figure 4). The Q-h curve is provided in Table 7.

Table 7 Downstream Q-h Rating Curve

Flow (m ³ /s)	Level (m)
0	199.83
18.2	200.11
30.3	200.51
38.9	200.72
53.7	201.01
63.9	201.18
79.8	201.42
404.3	204.76

3.2.6 1D Riverine Simulation Settings

The simulation settings applied in the MIKE 11 model include the following:

- Initial Conditions: Dry
- Solver Settings: Default values
- Simulation Period: Variable (dependent on design storm being simulated)
- Time step: Fixed time step = 0.2 seconds
- Results: Storing frequency = 1 minutes

3.3 2D Overland Model Development

The development of the 2D overland model was completed in MIKE 21 and included the following:

- prepare topographic surface file including obstructions and river block
- create 2D surface roughness file (Manning's n)
- assign boundary conditions

A schematic of the MIKE 21 model domain is provided in Figure 8 including the extent of the 2D domain, Manning's roughness, and boundary conditions. In order to ensure the boundary condition assumptions would not impact the results within the study area, the 2D domain was set sufficiently larger than the area of interest. The 2D domain is provided in Figure 8.

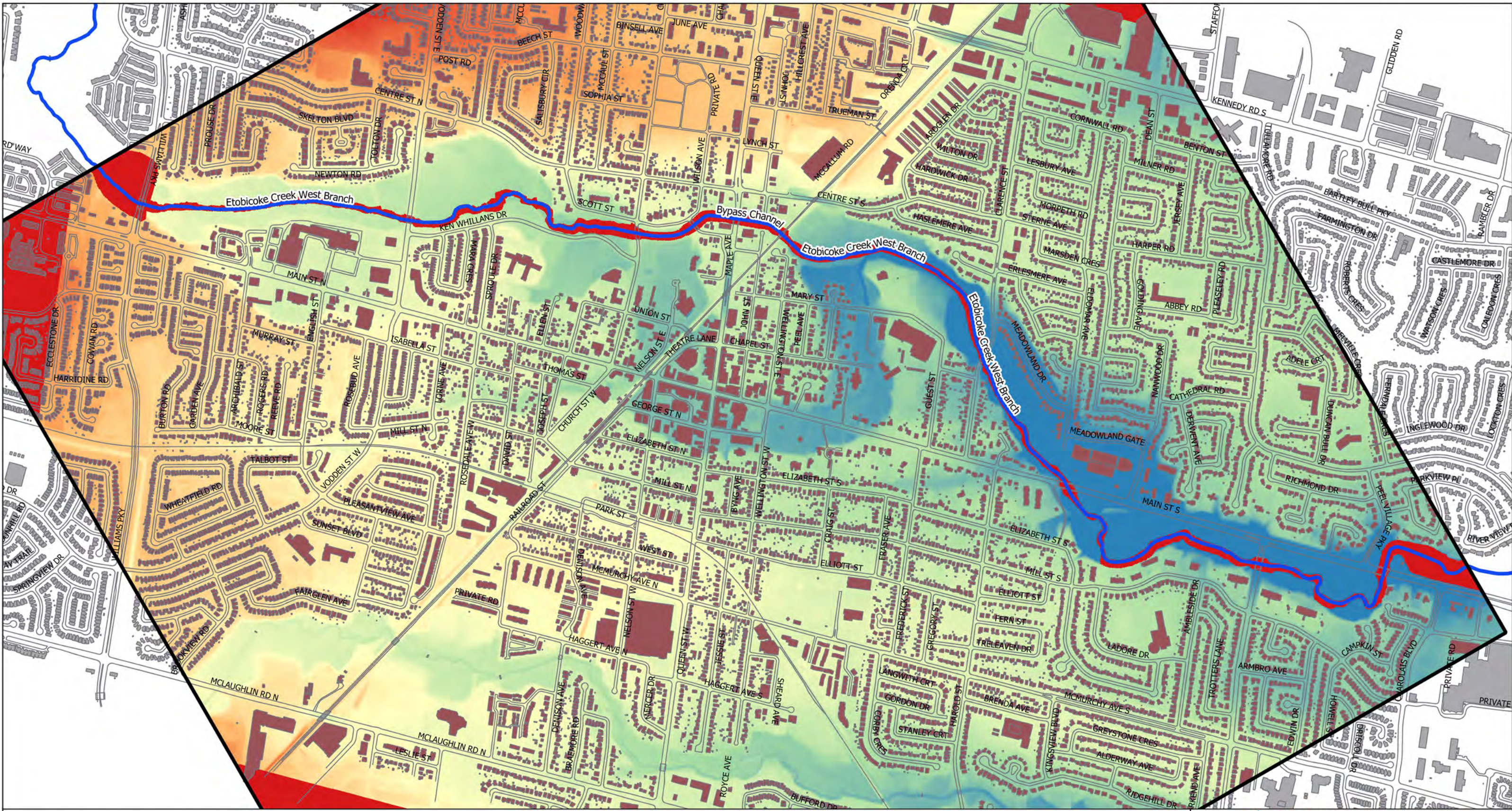







Figure Date: January 3, 2018

Legend

-  Watercourse
-  BUILDINGS
-  2DDomain

2D Model Raster (Topography)

-  207.6
-  214
-  220.3
-  226.6
-  233



Brampton Integrated Flood Study
Final Report

Project #22062

2D Riverine Model Schematic

Disclaimer: The information contained herein may be compiled from numerous third party materials that are subject to periodic change without prior notification. While every effort has been made by Matrix Solutions Inc. to ensure the accuracy of the information presented at the time of publication, Matrix Solutions Inc. assumes no liability for any errors, omissions, or inaccuracies in the third party material.

K. Molnar
K. Hofbauer

3.3.1 Topography

The 2D surface topography was prepared from the LiDAR-based DEM provided by TRCA (1 m resolution). MIKE 21 surface models can be represented as either a rigid grid or a flexible mesh. Rigid grid consists of square cells of a selected size across the entire 2D domain, while the flexible mesh consists of triangular mesh elements which may vary in size depending on the level of detail required in a specific area. The rigid grid is more stable and significantly less complex than flexible mesh. For this study a rigid grid model with a 2 × 2 m cell size is appropriate to sufficiently capture hydraulic controls for overland flow such as roadways and major overland flow routes. The 2D model domain was generated by resampling the LiDAR-based DEM to a 2 m cell size and converting to the required format for MIKE 21 (.dfs2).

3.3.1.1 Obstructions

The 2D surface incorporates building footprints as blocked obstructions to ensure water cannot flow through the buildings. The building footprints used to create the blocked obstructions within the 2D domain were based on shapefiles provided by the City during the background review.

3.3.1.2 River Block Removal

To couple the MIKE 11 and MIKE 21 model (refer to Section 3.4.2 for further details), the area occupied by the main channel must be removed from the 2D portion of the model to avoid double counting channel flow in both the 1D and 2D models. Therefore the area in the 2D surface bounded between the left and right banks of each cross-section was also treated as a blocked obstruction in the MIKE 21 model.

3.3.2 Surface Roughness

A spatially distributed map of Manning's n roughness values was created to reflect the different surface materials and vegetation throughout the 2D model domain. The Manning's n roughness map was developed based on the land use polygon layer for the study area provided by TRCA. The Manning's n roughness file has the same cell size and dimension as the 2D surface topography file.

Table 8 provides a summary of the TRCA Manning's roughness values used in the model. The methodology for applying roughness in MIKE FLOOD modelling is to use Manning's M (the inverse of Manning's n).

Table 8 Manning's Roughness Values

Land Use	Manning's n	Manning's M
Woods/Meadow/Cultivated Lands	0.08	12.5
Lawns	0.05	20
Wetland Area	0.035	28.6
Impervious Areas	0.025	40

3.3.3 2D Overland Model Boundary Conditions

The boundary conditions for the 2D model were assigned based on site conditions. The available options for assigning boundary condition options include either open or closed boundaries, wherein flow will be permitted to exit the system or be blocked, respectively. Since the inflows to the system and outflows from the system will be handled in the 1D MIKE 11 model, all 2D model boundaries will be closed, meaning no flow is permitted to exit the 2D domain via overland routes.

3.3.4 2D Overland Simulation Settings

The 2D MIKE 21 overland flow model provides a range of options for setting up and running the simulations. This section provides a listing of the settings used for this study.

- Solution Period
 - ✦ Time step: 0.2 seconds
 - ✦ Start time: Variable (dependent on design storm being simulated)
 - ✦ End time: Variable (dependent on design storm being simulated)
- Flood and Dry
 - ✦ Drying depth: 0.01 m
 - ✦ Flooding depth: 0.02 m
- Eddy Viscosity: 0.4 m²/s
- Initial Conditions: Dry
- Results
 - ✦ Items: Surface Elevation, Total Water Depth, U Velocity, V Velocity, Current Speed
 - ✦ Storing frequency: 10 minutes

3.4 3-Way Coupled Model Development

Once the MIKE 11, MIKE URBAN, and MIKE 21 model components were constructed the remaining step was to complete the 3-way coupling in MIKE FLOOD, which consisted of the following:

- Couple the 1D urban (MIKE URBAN) and 2D overland (MIKE 21) models
- Couple the 1D riverine (MIKE 11) and 2D overland (MIKE 21) models
- Couple the 1D urban (MIKE URBAN) and 1D riverine (MIKE 11) models

3.4.1 1D-2D Urban Coupling

CBs and manholes in the 1D urban model are coupled to the 2D overland model such that inflow and surcharge to and from the nodes can be dynamically exchanged between the two components. This allows for surcharged sewers to discharge onto the 2D overland flow model where it may either pool on the surface or flow in the direction where the topography is sloping. It also allows for flooding on the 2D surface to re-enter the 1D urban model via these nodes when capacity permits in the minor system.

The CBs and manholes are coupled to the 2D model grid cell coinciding with the location of the CB or manhole of interest. The rate of flow exchange between CB and manhole inflow and surcharge is detailed in the following sections.

3.4.1.1 CB Inflow

Each CB in the 1D urban model (including the CB manholes) was coupled to the 2D overland flow model using a curb inlet coupling method. The curb inlet method uses a depth versus flow (D-Q) relationship to control the rate at which water on the 2D surface can enter the CB.

The D-Q relationship for the CBs was obtained from the curve defining the inlet capacity of a single CB in a sag as defined in Design Chart 4.19 of the Ontario Ministry of Transportation's *Drainage Management Manual* (1997; refer to Figure 9). We used the specifications for a sag for all CBs since the main focus of the study is to examine flooding during large storm events when surface flooding conditions will likely submerge many of the CBs.

The freeboard value defines the depth of water below the ground surface at which the calculation of inflow from the 2D overland flow model into the 1D CB begins to be suppressed, thereby allowing for a relatively smooth transition between draining conditions and surcharge conditions. This was set to 0.1 m for all CBs.

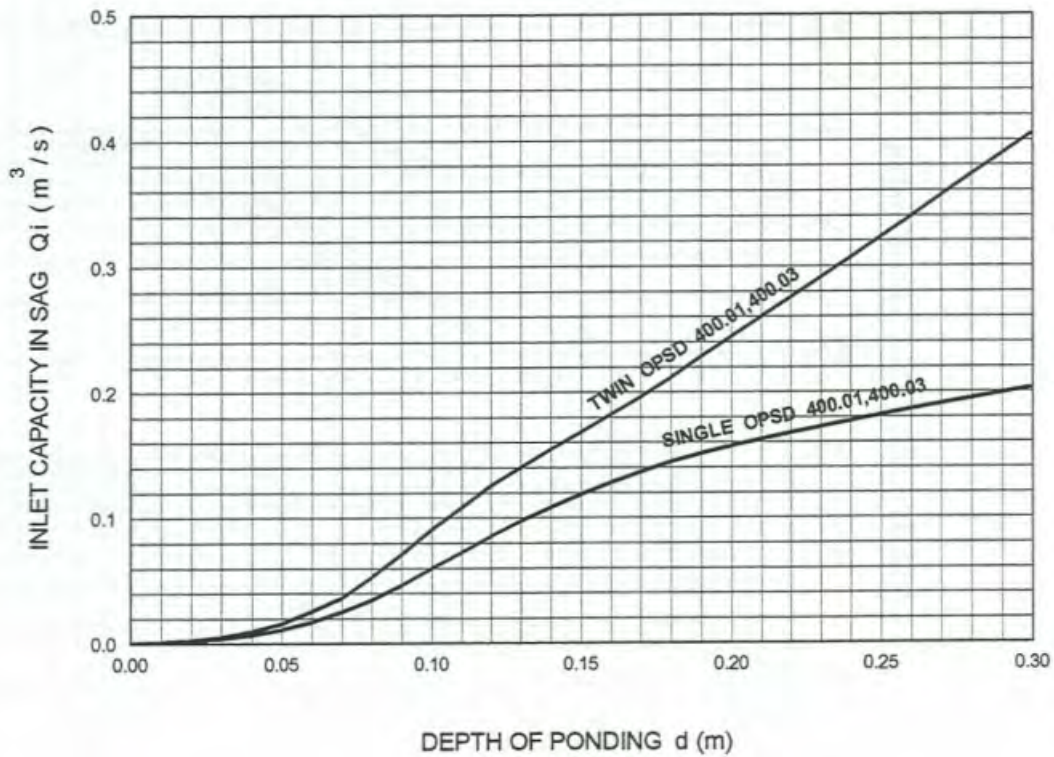

Figure 9 Catch Basin Inlet Capacity at Road Sag (Image Credit: MTO 1997)

3.4.1.2 Catch Basin Surge

The outflow (surcharge) from the CBs was estimated using an orifice equation to calculate the rate at which water from the CB will surcharge onto the 2D overland flow model. The orifice settings for the CBs were set as follows:

- Orifice area: 0.18 m² (assumed 50% open area on a CB measuring 0.6 × 0.6 m)
- Orifice discharge coefficient: 0.3 (assumes low efficiency caused by drag from many small openings)
- Maximum flow: 0.22 m³/s (assumes the maximum rate of surcharge from the CB would not be more than the maximum rate of drainage into the CB)

3.4.1.3 Manhole Inflow

As with the CBs, each manhole in the 1D urban model was coupled to the 2D overland flow model using the curb inlet coupling method. The curb inlet method was selected because it allows the inflow to be restricted to a very low rate when the manhole lid is in place, while the outflow can be much larger to account for cases when the surcharge lifts and displaces the manhole cover (refer to Section 3.4.1.4).

The D-Q relationship for the manholes was estimated assuming inflow occurs through the two pick axe lift holes and some additional leakage around the rim. For lack of better data we assumed the leakage

around the rim is equivalent to a third pick axe lift hole. Based on a total orifice flow area of 0.0025 m² and a discharge coefficient of 0.6, the D-Q relationship curve provided in Table 9 was developed using the following orifice equation (MIKE FLOOD Manual, p 112).

$$Q = C_d A \sqrt{2g\Delta H}$$

Where: Q = flow rate (m³/s)
 C_d = orifice discharge coefficient, assumed to be 0.6
 A = area of orifice, assuming two lift holes (1"x1") plus leakage around the rim, assumed to equal a third lift hole (m²)
 g = gravitational acceleration constant (m/s²)
 ΔH = water depth over manhole for each storm event (m)

Table 9 Depth-Flow Curve for Manhole Inflow

Depth (m)	Flow (m ³ /s)
0.00	0.00000
0.05	0.00150
0.10	0.00212
0.15	0.00260
0.20	0.00300
0.25	0.00335
0.30	0.00367
0.40	0.00424
0.50	0.00474
1.00	0.00671

3.4.1.4 Manhole Surge

The outflow (surcharge) from the manhole was estimated using an orifice equation to calculate the rate at which water from the manhole can surcharge onto the 2D overland flow model. The orifice settings for calculating surcharge flow out of the manholes were set as follows:

- Orifice area: 0.26 m² (assumed manhole opening diameter of 0.575 m per OPSD 401.010)
- Orifice discharge coefficient: 0.6 (assumed standard orifice discharge coefficient)
- Maximum flow: 1.2 m³/s (estimated using the orifice equation described above)

Since there can only be one setting for the orifice we assumed the manhole lid would be lifted off during the surcharge conditions to account for the potentially worst-case conditions during an extreme event.

The freeboard value defines the depth of water below the ground surface at which the calculation of inflow from the 2D overland flow model into the 1D manhole begins to be suppressed, thereby allowing

for a smooth transition between draining conditions and surcharge conditions. This was set at 0.1 m for all manholes.

3.4.2 1D-2D Riverine Coupling

The 1D riverine model was coupled to the 2D overland model using the lateral weir coupling option. Using this option the flow exchange is calculated using a standard weir equation based on the elevation of either the 1D or 2D model at that location, whichever is higher. Lateral links were established on both banks of the creek to allow flow exchange to occur on either side.

3.4.3 1D Urban-1D Riverine Coupling

The outlets from the 1D urban model (i.e. stormwater outfalls) were connected to the 1D riverine network to allow for a two-way exchange of water between the 1D urban model and the 1D riverine model. All of the outlets from the 1D urban model are connected to the 1D riverine model at the chainage of the river cross-section located nearest to the outlet. The calculated water levels from the 1D urban model and the 1D riverine model are compared and the difference is used to determine the direction of flow exchange (i.e., normal drainage conditions under which water flows from the 1D urban model to the 1D riverine model or backwater conditions where water flows from the riverine model into the 1D urban model). As a result, the 1D riverine model becomes the downstream boundary condition for the 1D urban model.

3.4.4 3-Way Coupling

The 3-way coupling was achieved by combining the three model components described above using MIKE FLOOD. The coupling parameters prepared in the previous steps were used to provide a fully integrated model such that flows are dynamically exchanged between each of the three systems.

To ensure that the 3-way coupled model was performing adequately under extreme flow conditions, trial runs were conducted using the Regional Storm flow. With all components coupled the model was found to be functioning as expected with no instabilities; therefore, the calibration and validation process was initiated.

4 MODEL CALIBRATION AND VALIDATION

Ideally hydraulic models are calibrated to known water levels and/or measured flow data over a range of storm events. Flow monitoring data in the sewer system collected over the summer of 2007 was available and used to calibrate the urban model. The flow monitoring equipment was installed in May 2007 and maintained until November 2007 (Aquafor 2008).

Water Survey of Canada gauge 02HC017 is within the study area (just upstream of Church Street). This gauge has daily data available from 1957 to present. However, to use this data for calibration, we would

require finer time intervals. In addition, multiple rainfall gauges covering the headwaters of Etobicoke Creek areas upstream would be required to accurately calibrate the riverine model. The rainfall gauge at City Hall is not appropriate for use across the entire Etobicoke Creek watershed. Therefore, since flow data was not available for the riverine system, the riverine portion of the model was validated against the existing HEC-RAS model to ensure it was functioning adequately.

Calibration of the 2D overland model requires observed data recorded during high flow events (i.e., documented high water marks) as well as the associated rainfall and flow data for the area of interest. However, sufficient data of this sort is often not available and therefore alternate validation methods are required. Our typical approach includes:

- reviewing anecdotal evidence from residents or social media (i.e., photos or videos taken during flood events)
- gathering rainfall data from the nearest reliable gauge to prepare appropriate model inputs
- estimating the observed water levels from the anecdotal information using surrounding features (i.e., curb heights, vehicles, etc.)
- comparing these estimated water levels to those from the 2D model results

While this is not a typical calibration approach it is a suitable method of validating the model to ensure the results are reasonable when sufficient monitoring data is lacking.

4.1 Flow Monitoring Data Review

Available flow monitoring and rainfall data was reviewed and analyzed in support of calibration. The goal of this task was to identify any correlation of flows between the flow monitoring stations, to assess the correlation between the flow monitoring data and the rainfall data, and to select representative rainfall events to use for calibration.

Flow monitoring data collected in the summer of 2007 for the DDS (Aquafor 2008) was provided by the City for use in the current study. Two flow monitoring stations were located in the storm sewer along Main Street; one immediately upstream of Church Street (Church Station), and one at Etobicoke Drive (Etobicoke Station). A rainfall gauge was also installed for the same study at City Hall near the corner of Queen Street and George Street. Due to the relatively small size of the study area, applying a single rainfall time series to all catchments is appropriate. The locations of the flow monitoring stations and rain gauge are shown in Figure 10.

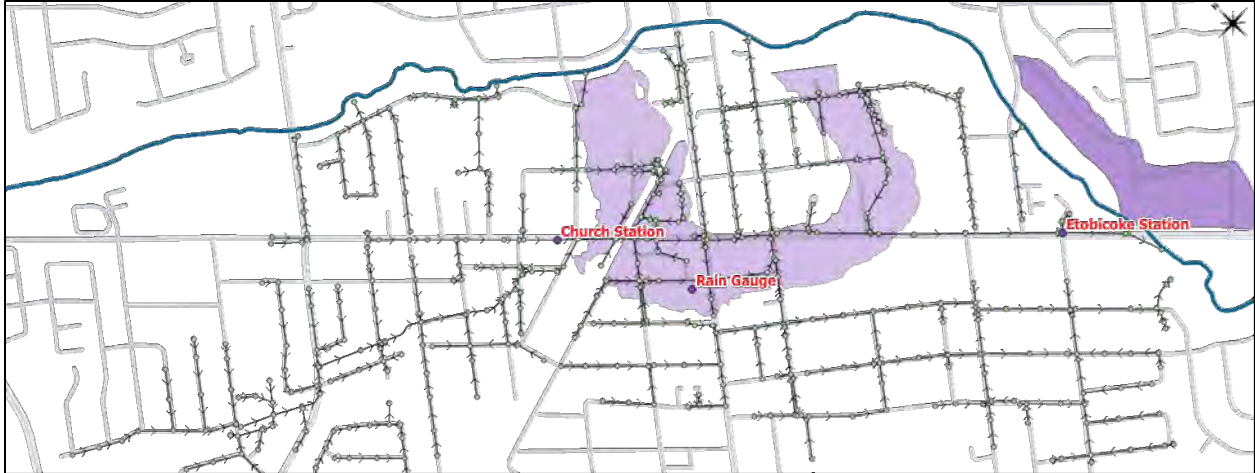

Figure 10 Flow Monitoring Station Locations

4.1.1 Analysis of Measured Rainfall

Table 10 summarizes the characteristics of the rainfall events captured during the monitoring period. There were nine rainfall events with 3 mm or more of total rainfall identified during the summer of 2007. The storm sewer system responds very quickly to rainfall events due to the size and land use of the study area (i.e., flows are observed soon after the rainfall starts and decline quickly after rainfall stops). Given this quick runoff response, the separation between rainfall events was defined by a period of 2 hours or more without measured rainfall. The rainfall gauge recorded rainfall accumulation in 5 minute intervals.

The largest rainfall events occurred on May 27, June 3 to 5, and July 19 with 7.2 mm, 9.4 mm, and 17.4 mm of rain recorded during these events, respectively. The May 27 event had a duration of 20 minutes and a peak rainfall intensity of 54 mm/hr. The June 3 to 5 event included a combined total of 12.7 hours of rainfall with a peak rainfall intensity of 35 mm/hr on June 5. The July 19 event consisted of three distinct rainfall periods occurring over the course of the day and had a peak rainfall intensity of 35 mm/hr occurring over a 20 minute period.

By comparison, a 2-year AES design storm accumulates approximately 32 mm of rainfall in 3 hours with a peak intensity of 19 mm/hr, while a 5-year AES design storm accumulates approximately 41 mm of rainfall in 3 hours with a peak intensity of 25 mm/hr. These design storm analyses were extracted from the peak 3 hour period of the 12 hour AES design storms for each event.

Although the peak rainfall intensities during the May 27 and July 19 events are higher than the 2- and 5-year AES design storm events, the duration of the peak intensity is very short in both cases and the total depth of rainfall is less than the 2-year AES design storm event. While the 2007 rainfall data is useful for calibrating the model under low flow conditions, it unfortunately did not capture storm events large enough to provide insight into flooding conditions; however, the measured flow response is sufficient to assess the ability of the model to simulate observed flows using reasonable parameters.

Table 10 Analysis of Rainfall vs. Measured Flow

Rainfall Event	Rain Gauge			Church Station			Etobicoke Station		
	Duration (hrs)	Peak Intensity (mm/hr)	Total Depth (mm)	Peak Flow (m ³ /s)	Total Flow (m ³)	Normalized Flow (m ³ /1,000 ha)	Peak Flow (m ³ /s)	Total Flow (m ³)	Normalized Flow (m ³ /1,000 ha)
May 27 (3:00 - 3:20 pm)	0.33	54	7.2	0.09	62	7.7	1.52	2,626	20
June 3 (7:25 pm - 7:50 am)	12.42	4	5.2	0.002	12	1.5	0.10	1,824	14
June 5 (8:25 - 8:40 am)	0.25	35	4.2	0.08	60	7.5	0.67	1,592	12
July 8 (9:35 - 11:10 am)	1.58	12	5.2	0.02	43	5.4	0.37	1,628	13
July 14 (2:20 - 4:15 pm)	1.92	6	4.7	0.02	46	5.7	0.49	1,722	13
July 18 (5:55 - 7:05 pm)	1.17	25	5.1	0.03	31	3.9	0.48	1,345	10
July 19 (4:40 - 7:50 am)	3.17	17	7.1	0.04	62	7.7	0.58	2,479	19
July 19 (2:15 - 2:35 pm)	0.33	35	6.1	0.08	66	8.2	1.11	2,207	17
July 19 (6:15 - 6:50 pm)	0.42	17	4.2	0.04	33	4.2	0.54	1,546	12

*** Bold italics indicates events selected for calibration and validation**

4.1.2 Correlating Measured Flow to Rainfall Data

The rainfall gauge used for this study was located in the core of Downtown Brampton. Due to the nature of summer rainfall events (i.e., highly localized and intense) inconsistencies may occur between rainfall measured at meteorological stations, observed rainfall spread across the model area, and the flow response measured in the collection system. The purpose of correlating the measured flow to the rainfall data is to identify the events which are best suited for model calibration. Events that demonstrate a good correlation between the measured rainfall and the measured flow response in the sewer system are best suited to model calibration.

Figure 11 and Figure 12 illustrate time series plots of rainfall vs. measured flows at the Etobicoke Station and Church Station, respectively. Figure 13 illustrates a scatter plot of peak measured flows vs. peak rainfall intensity. Figure 13 shows a good visual correlation between the peak flows and peak rainfall intensities at Etobicoke Station with two exceptions; (1) the precipitation event measured on June 28 shows no flow response at the Etobicoke Station; and (2) the relatively high measured flows at both stations on June 19 are not supported by a correspondingly large rainfall event.

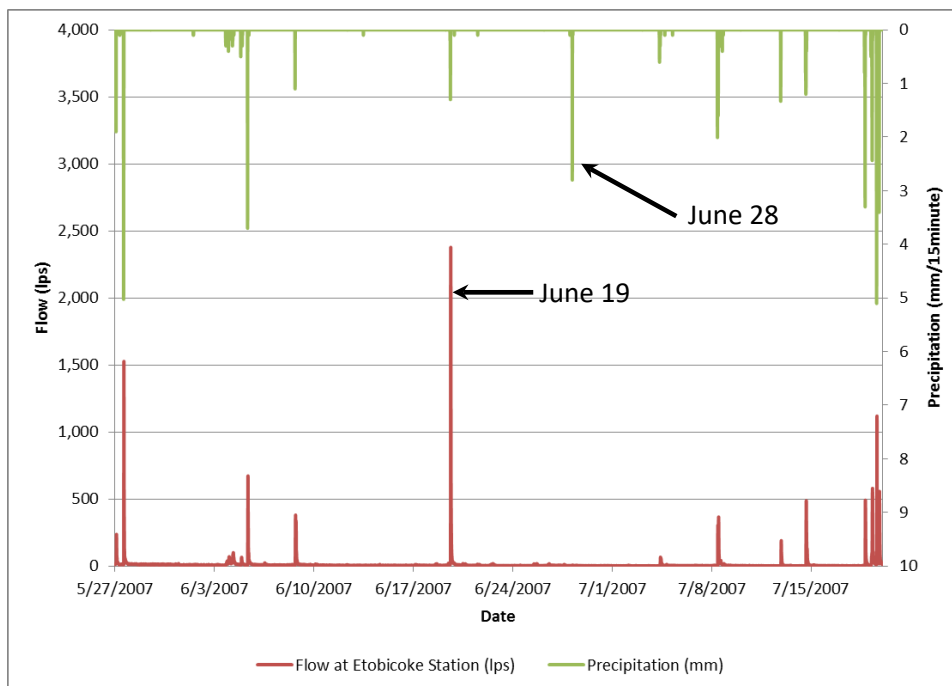

Figure 11 Comparison of Rainfall Depth and Measured Flow - Etobicoke Station

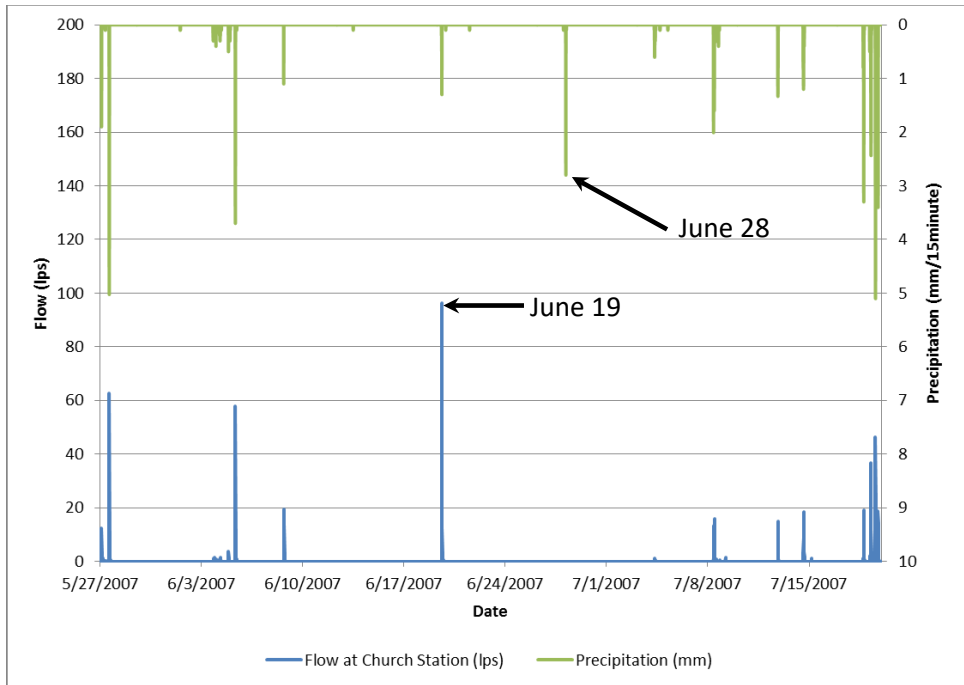

Figure 12 Comparison Rainfall Depth and Measured Flow - Church Station

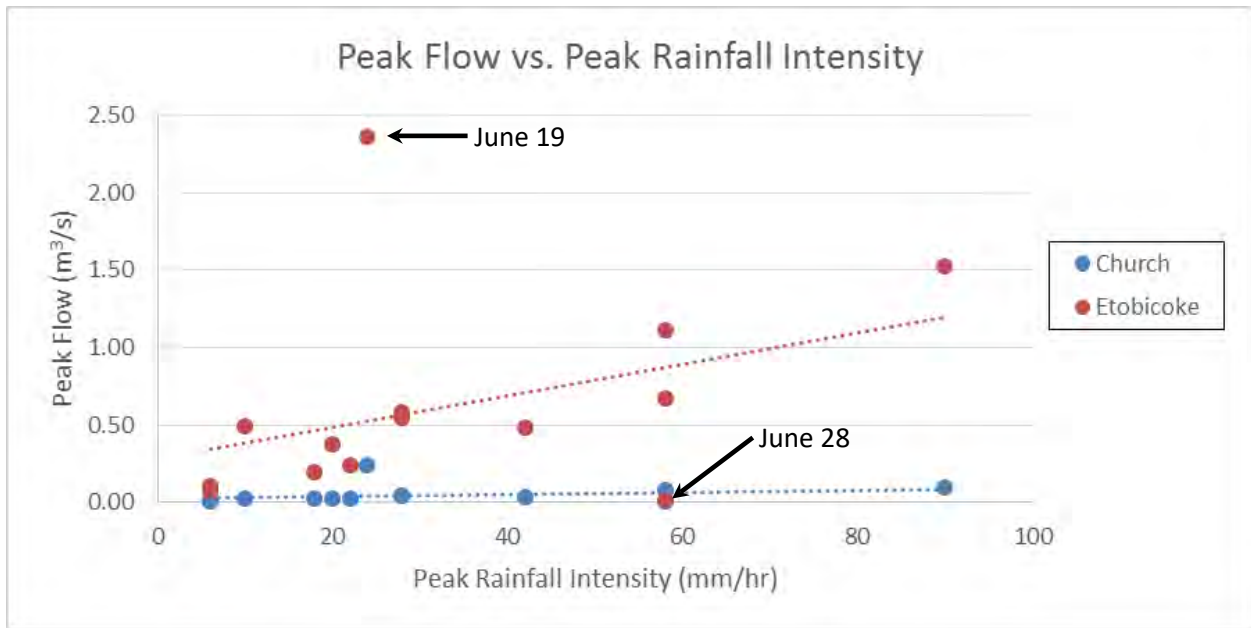

Figure 13 Scatter Plot of Peak Flow vs. Peak Rainfall Intensity

Figure 14 to Figure 19 provide a detailed comparison of measured rainfall and measured flow for selected rainfall events. In each case the measured peak flows in the collection system correspond well with the measured peak rainfall depths. The peak measured flows consistently occurred 1 hour before the peak rainfalls. We assumed the offset in the measured peaks was due to a one hour offset in the clocks at the rainfall measurement station and the flow measurement stations (this often occurs due to

daylight savings time). For the purposes of this study, we adjusted the rainfall time series backward by one hour to synchronize with the flow measurement time series.

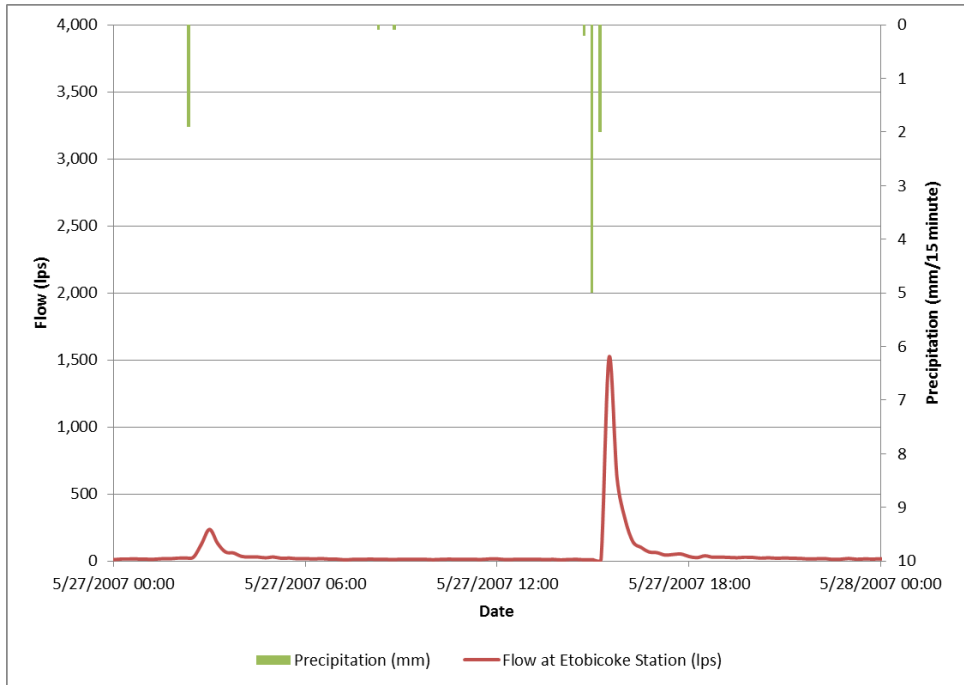

Figure 14 Rainfall Depth vs. Measured Flow - Etobicoke Station May 27

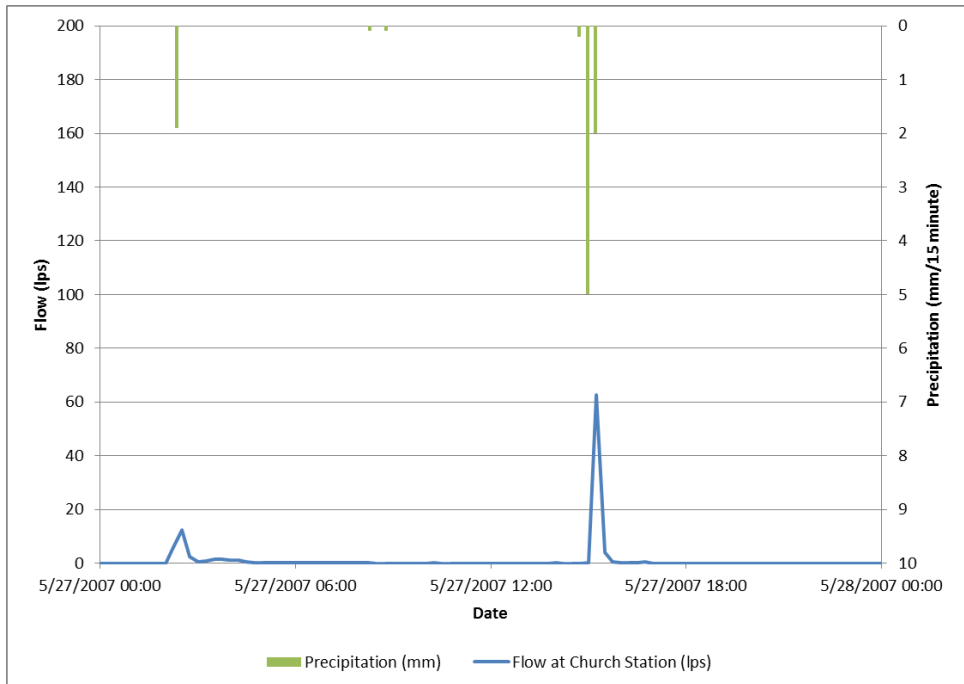

Figure 15 Rainfall Depth vs. Measured Flow - Church Station May 27

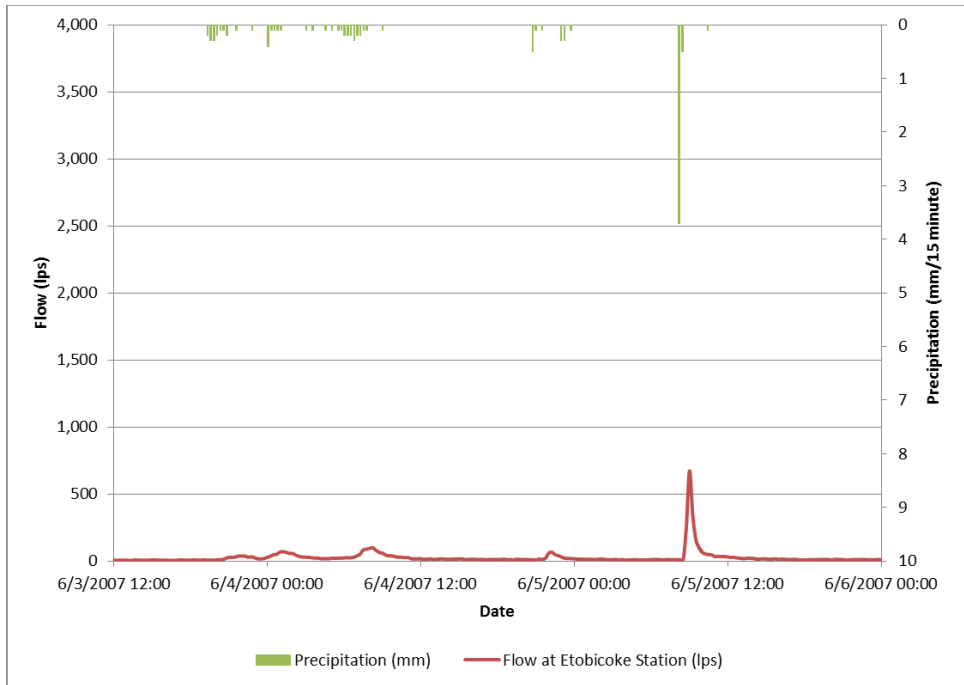

Figure 16 Rainfall Depth vs. Measured Flow - Etobicoke Station June 3 to 5

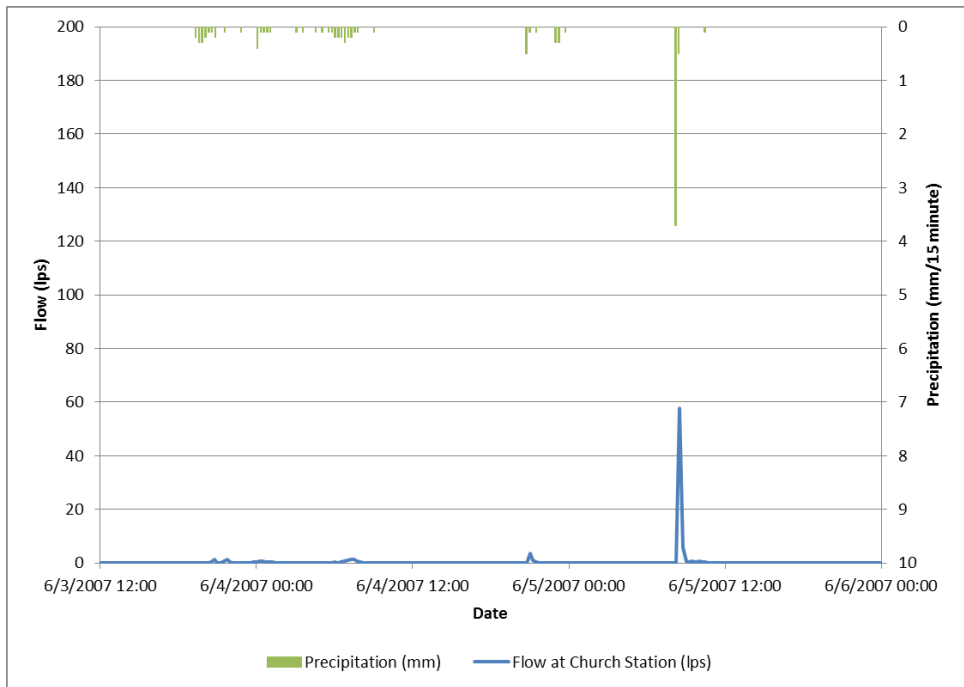

Figure 17 Rainfall Depth vs. Measured Flow - Church Station June 3 to 5

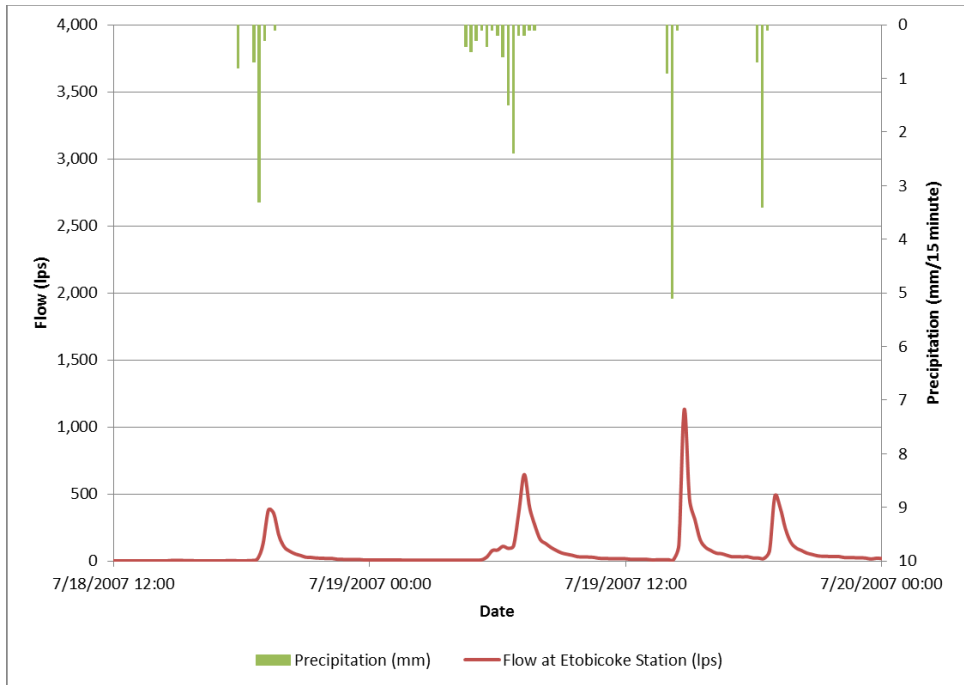

Figure 18 Rainfall Depth vs. Measured Flow - Etobicoke Station July 18 to 19

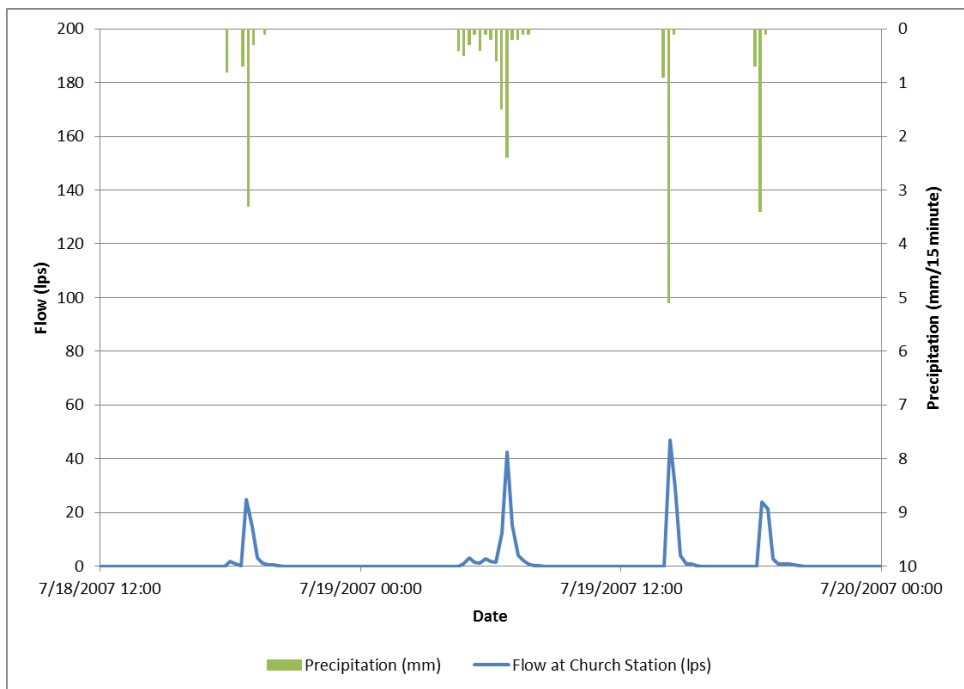

Figure 19 Rainfall Depth vs. Measured Flow - Church Station July 18 to 19

4.1.3 Monitoring Station Variation

The contributing catchment area for the Church Station is approximately 8 ha while the contributing area for the Etobicoke Station is approximately 135 ha (see Figure 20). The correlation of data between the two flow monitoring stations was assessed to identify trends and inconsistencies in the measured

flow data as well as to provide possible explanations for differences between the datasets. These differences may include physical features such as stormwater management controls, different land uses, or incomplete or erroneous monitoring data.



Figure 20 Contributing Catchment Areas for Flow Monitoring Stations

Figure 21 illustrates the normalized flows vs. rainfall depth for each rainfall event (note: the June 19 and June 28 events were removed from this plot). Using normalized flows allows for a direct comparison of observed flow to recorded rainfall depth without considering the influence of drainage area. The normalized flows were derived by dividing the total measured flow volume by the contributing catchment area. Given the relative similarities in land use types between the Church Station catchment area and the Etobicoke Station catchment area, the normalized flow for each station was expected to be similar. However, the normalized total flow at the Church Station is approximately 40 to 50% of the normalized total flow at the Etobicoke Station. This figure also illustrates that, although there is a trend, there is not a very good correlation between measured flow and rainfall depth at that Church Station.

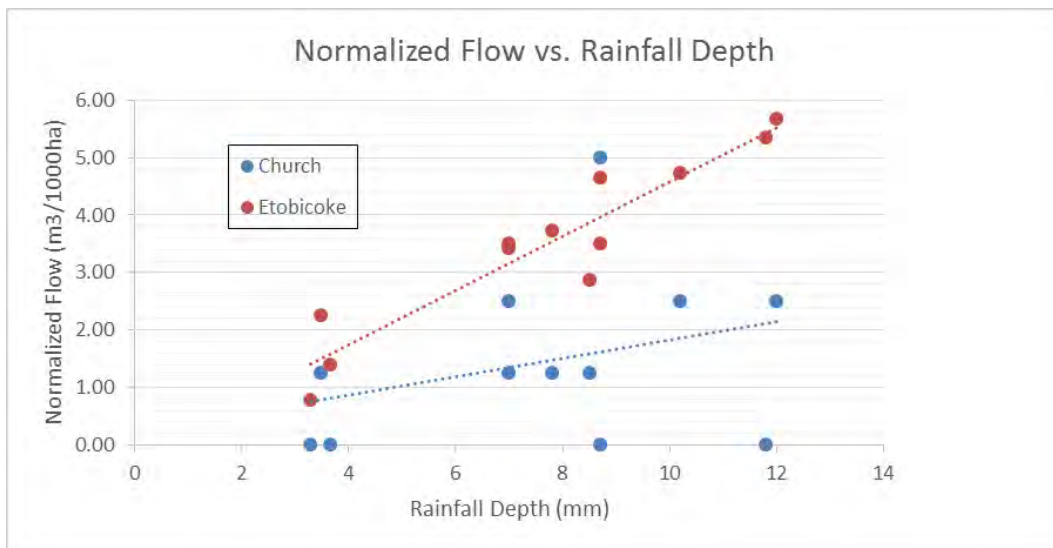

Figure 21 Normalized Flow vs. Rainfall Depth

The inconsistencies in the normalized flow at the Church Station indicate the measured flow at this station could be unreliable. This may be a result of very small depths and velocities at Church Station relative to measurement precision/accuracy. As a strong correlation between measured flow and rainfall depth at that Church Station is not present, the results at this station were not used for calibration. This is also consistent with the findings of the DDS (Aquafor 2008) in which the Church Station monitoring data was not used for calibration. While the Church Station data was not directly used in the calibration, the drainage area to the Etobicoke Station encompasses that of the Church Station. Therefore, the catchments drainage to the Church Station were accounted for in the calibration process.

4.1.4 Calibration and Validation Event Selection

Based on the analysis of monitoring data, the precipitation events on May 27, June 3 to 5, and July 18 to 19 were identified as the most suitable for model calibration purposes. The calibration focused on the July 18 to 19 period because there were four significant precipitation events in close succession. The resulting calibrated model was validated against the May 27 and the June 3 to 5 rainfall events.

4.2 Urban Model Calibration Methodology

The objective of calibration is to ensure that models can reproduce observed results over a range of rainfall events. Calibration to measured flows is ideal but in the absence of measured data, particularly for large storm events, validation can be completed based on anecdotal data (i.e., photographs, videos, personal accounts of high water marks), or against estimates of sewer capacity (i.e., is the sewer designed for 5-year event?).

The approach to model calibration focused mainly on the hydrologic component of the urban model. While the hydraulic parameters can also be used to adjust the flow response, pipe roughness and manhole losses are the primary hydraulic parameters influencing flow response and there is only a small range of reasonable values for these parameters. Adjusting parameters outside a reasonable range and/or adjusting the wrong parameters may achieve a match to a specific monitored dataset but may not translate well to another event of different duration or intensity. Faulty adjustments such as these do not provide a robust calibration.

The model was therefore calibrated by adjusting the hydrologic parameters within a reasonable range until an acceptable match was achieved between the measured and modelled peak flows and runoff volumes at the flow monitoring stations for selected rainfall events.

4.2.1 Hydrologic Model

There are four different surface runoff computation methods available in MIKE URBAN. These methods include: a) Time/Area Method, b) Kinematic Wave (non-linear reservoir) Method, c) Linear Reservoir Method, and d) Unit Hydrograph Model.

The kinematic wave hydrologic model in MIKE URBAN was used to simulate rainfall runoff from catchments to the connected manholes. This method provides a comprehensive representation of the main processes influencing rainfall runoff to the stormwater collection system including runoff from impervious areas, and runoff and infiltration from pervious areas. Surface runoff is computed as shallow, laminar sheet flow taking into account the gravitational and friction forces. The amount of runoff is controlled by various hydrological losses and the size of the contributing area.

The shape of the runoff hydrograph is controlled by the catchment parameters including the average drainage path length and slope and the roughness of the catchment surface. These parameters form a basis for the kinematic wave computation which uses the Manning equation.

4.2.2 Calibration Parameters

The model calibration consisted of an iterative process of adjustments to the hydrologic parameters and review of resulting flows at the monitored locations. This was repeated until satisfactory results were achieved. A summary of parameters used in the MIKE URBAN hydrologic model is provided in Table 11.

Table 11 Summary of Kinematic Wave Hydrologic Model Parameters

Parameter	Description
Calculated Catchment Parameters	
Length (m)	Length of surface drainage path
Slope (%)	Average slope of surface drainage as shallow laminar sheet flow
Impervious Area (%)	Fraction of catchment surface containing impervious surfaces (e.g. rooftops, roads, and parking lots)
Pervious Area (%)	Fraction of catchment surface consisting of permeable surfaces (e.g. yards, parks, woodlot, etc.)
Kinematic Wave Parameters	
Wetting Loss (mm)	Initial wetting of the catchment surface
Storage Loss (mm)	Precipitation depth required for filling the depressions on the catchment surface prior to occurrence of runoff
Start Infiltration (mm/hr)	The maximum rate of infiltration (Horton)
End Infiltration (mm/hr)	The minimum rate of infiltration (Horton)
Horton's Exponent (/hr)	Determines the rate of reduction of the infiltration rate reduction over time during rainfall
Inverse Horton's Exponent [/hr)	Determines the rate of recovery of the infiltration rate over time after rainfall has stopped
Manning's n	Roughness of the catchment surface. <i>Based on TRCA Standards</i>

The calculated catchment parameters were initially determined based on the available GIS data as presented in Section 3.1.1.2. Sensitivity analyses were completed on the lengths and slopes; it was determined that the values of these parameters were acceptable. The ratios of pervious and impervious areas were reviewed in consideration of directly connected and non-connected imperviousness. The following summarizes the conclusions of this assessment for each identified land use:

- The areas occupied by large buildings were considered to be 100% impervious and the runoff from these buildings was assumed to be directly connected to the drainage network (connected roof drains are typical for these developments).
- While the rooftops of small buildings are 100% impervious, we considered that the entire roof area will not be directly connected to the drainage network (i.e., some will be directed to the yards). In addition, we assumed a portion of the impervious rooftops will account for impervious cover from driveways and sidewalks which were not accounted for in the residential pervious areas. The final connected impervious area used in the MIKE URBAN model is 50% of the total small building areas within each catchment.
- The remaining land use areas classified as impervious (i.e., roads, parking lots, etc.) are assumed to be 100% impervious and directly connected to the drainage network. While this may not be the case in all circumstances it is a reasonable assumption for the majority of the study area.

The kinematic wave parameters were defined globally for each land use type and were initially set based on standard values (CVC 2011). These parameters were adjusted during the model calibration process. The initial and final parameter values are provided in Table 12.

Table 12 Kinematic Wave Hydrologic Parameters

Parameter	Initial *		Final	
	Pervious	Impervious	Pervious	Impervious
Wetting Loss (mm)	5.0	2.0	2.0	0.1
Storage Loss (mm)			5.0	2.0
Start Infiltration (mm/hr)	75	n/a	75	n/a
End Infiltration (mm/hr)	3	n/a	7.5	n/a
Horton's Exponent (/hr)	2.0	n/a	2.0	n/a
Inverse Horton's Exponent (/hr)	1.0	n/a	1.0	n/a
Manning's n	0.05	0.025	0.05	0.025

* Initial values were based on CVC Standard Parameters (CVC 2011)

4.3 Urban Model Calibration Results

Model calibration/validation runs were completed for the three identified rainfall events recorded at the Etobicoke Station (refer to Section 4.1) until a reasonable match was achieved. Comparisons of the measured versus modelled flows at the Etobicoke Station are presented in Figure 22 to Figure 24.

4.3.1 Etobicoke Station

For the July 18 to 19 calibration period the model results match reasonably well with the measured peak flows and volumes at the Etobicoke Station. The model slightly underestimated the peak flow for the first and third events, overestimated peak flow for the second event, and matched peak flow for the

fourth event. The flow volumes (area under the curve) match very well for the first, third, and fourth events, while the model overestimated volume for the second event.

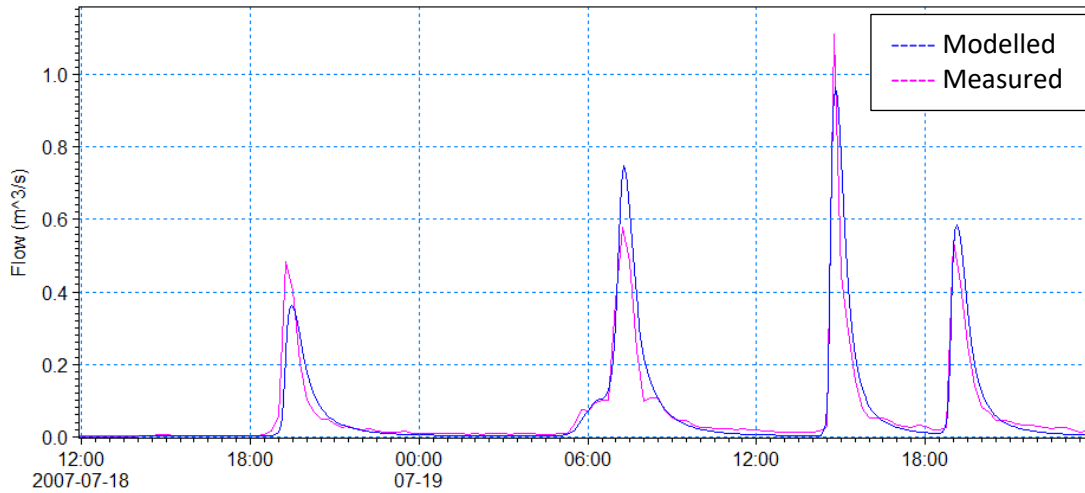

Figure 22 Measured vs. Modelled Flow - Etobicoke Station July 18 to 19

For the June 3 to 5 calibration period the model results match well with the measured peak flow, timing and volume at the Etobicoke Station for the small events on June 3 as well as the larger event on June 5. For the June 5 event the model underestimated peak flow by approximately 25% but the total flow volume is comparable.

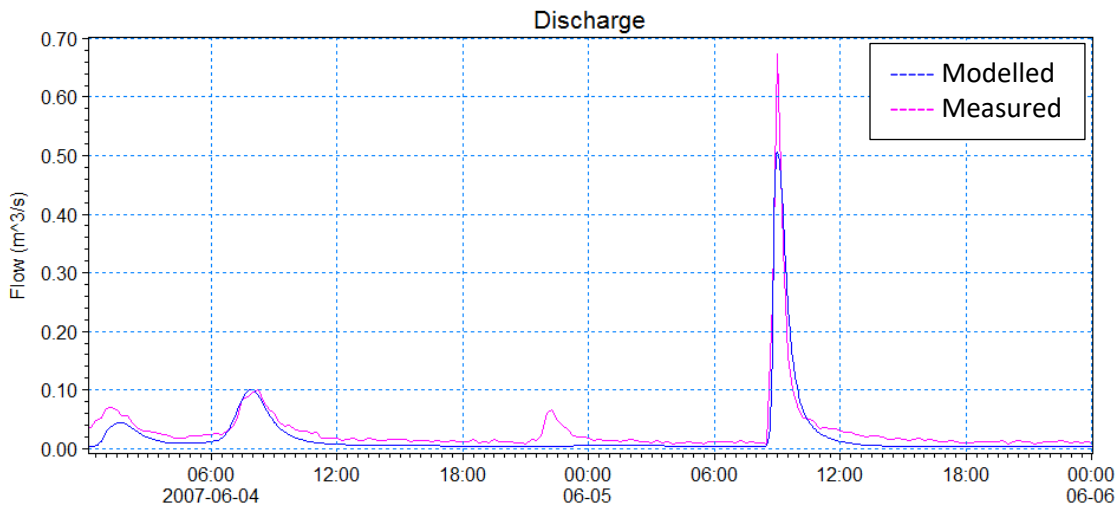

Figure 23 Measured vs. Modelled Flow - Etobicoke Station June 3 to 5

For the May 27 calibration period the model results closely match the total flow volume measured at the Etobicoke Station; however, peak flow is underestimated by approximately 20% and the response time is delayed by approximately 7 minutes.

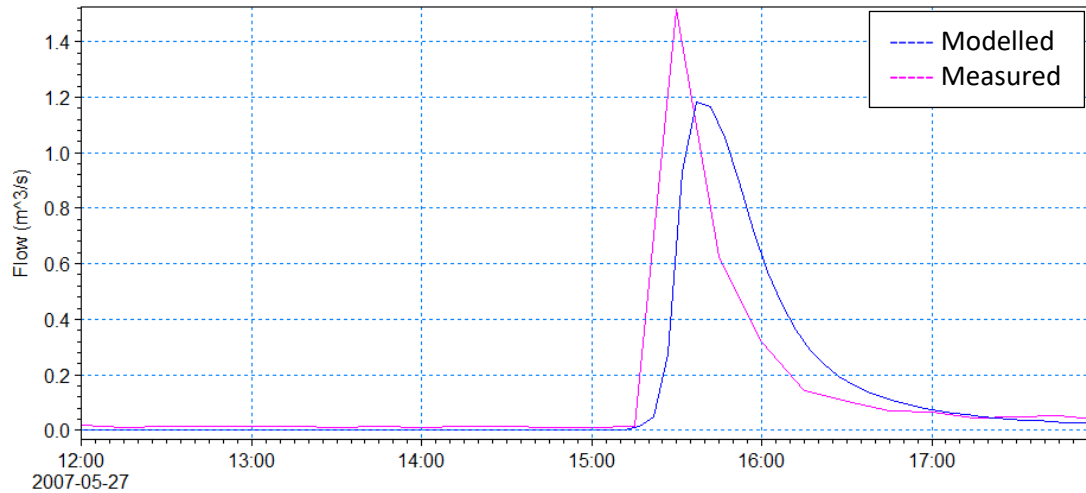

Figure 24 Measured vs. Modelled Flow - Etobicoke Station May 27

A verification process of flow volumes for each event was completed based on the calibrated model results. Table 13 summarizes the results of this assessment.

Table 13 Comparison of Measured and Modelled Event Volumes at Etobicoke Station

Event	Difference (m ³) *	% Difference
July 18 to 20, 2007	628.8	7%
June 5, 2007	-101.3	-6%
May 27, 2007	175.0	7%

* Modelled event volume minus measured volume. Positive number indicates modelled event has higher volume than measured; negative number indicates modelled event has lower volume than measured.

4.3.2 Church Station

For reference purposes the results at the Church Station are provided in Figure 25 to Figure 27.

For the July 18 to 19 calibration period at Church Station, the model overestimated the peak flows and volumes for all rainfall events. However, this is consistent with the comparison of total measured flows at each station where the flows at the Church Station were lower than expected. Due to these inconsistencies, calibrating using the Church Station would compromise the integrity of the hydrology model parameters and therefore the Etobicoke Station was used for calibration purposes.

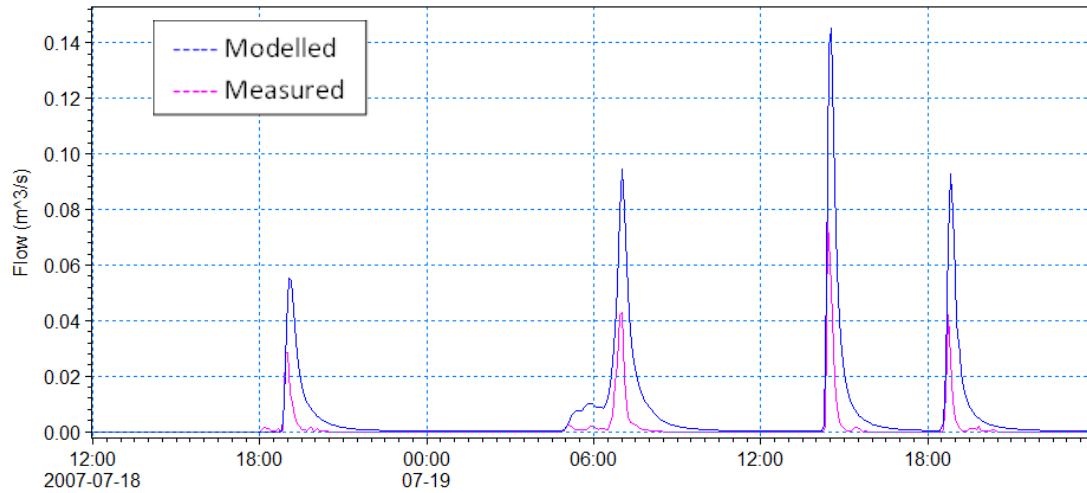

Figure 25 Measured vs. Modelled Flow - Church Station July 18 to 19

At the Church Station the model overestimates measured flow for the small events on June 3 but it provides a very good match for the event on June 5.

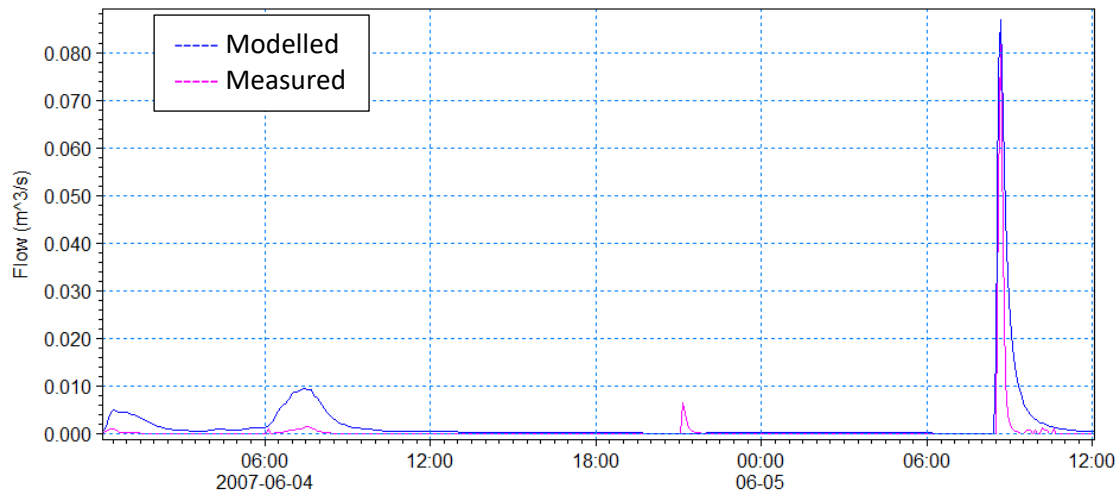

Figure 26 Measured vs. Modelled Flow - Church Station June 3 to 5

For the May 27 calibration period the results at the Church Station significantly overestimates the measured peak flow and volume.

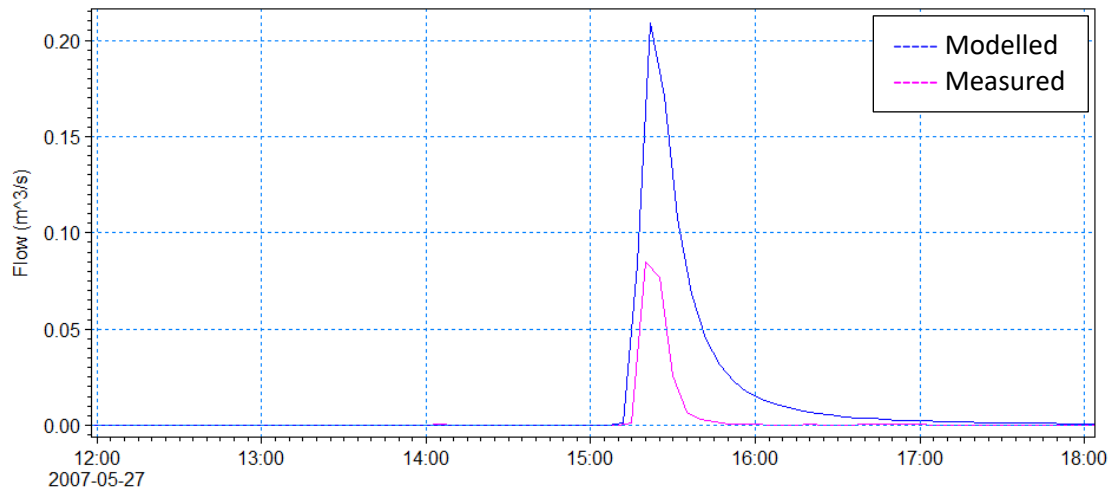

Figure 27 Measured vs. Modelled Flow - Church Station May 27

4.3.3 Summary

In general, the model provides a reasonably good match to the measured peak flow rates and overall volume at the Etobicoke Station for each of the three periods selected for calibration. Given the inconsistencies observed in the measured flows from the Church Station and the consistently good calibration achieved at the Etobicoke Station for all three calibration events, we proceeded with this version of the model. The differences between the observed and modelled data are consistent with industry standards as well as the calibration results from the broader watershed hydrology process.

4.4 Riverine Model Validation

Additional validation was completed to investigate discrepancies between the existing HEC-RAS model and the MIKE 11 model near Church Street. The validation exercise included assessment of the impacts of modelling the low flow channel within the concrete bypass channel.

4.4.1 Comparison of Water Surfaces

Differing water elevations computed by HEC-RAS and MIKE 11 were identified. To confidently proceed with utilization of the model results, the cause of these differences had to be determined. Figure 28 shows the simulated channel invert and water surfaces for the 50-year event in the MIKE 11 model and the existing HEC-RAS model (Valdor 2017). The figure highlights two areas where differences in water surfaces arise: downstream of the pedestrian bridge and in the vicinity of Church Street.

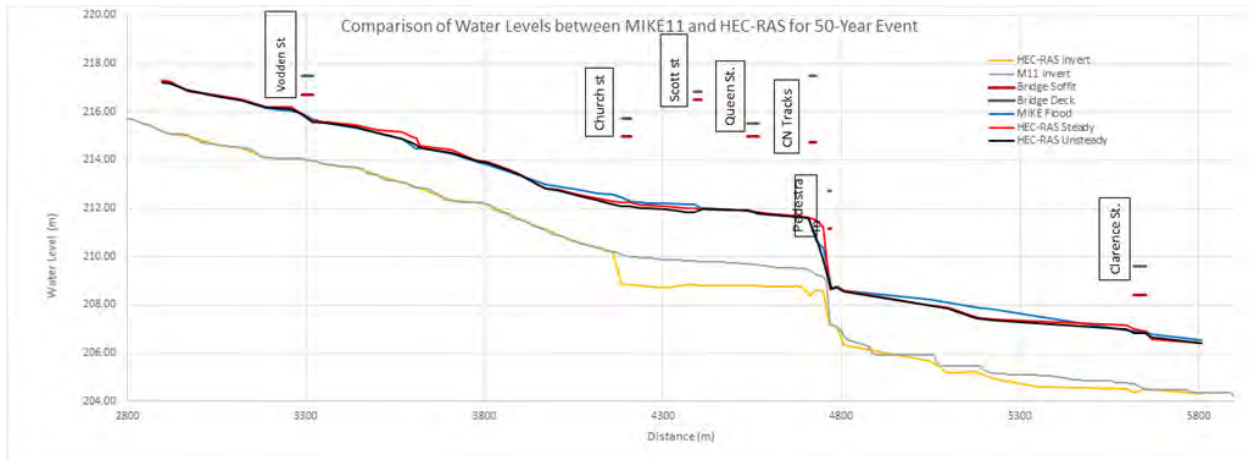

Figure 28 Comparison of Water Level between MIKE 11 and HEC-RAS for 50-Year Event

TRCA confirmed that the HEC-RAS model used existing HEC-RAS cross-sections downstream of the pedestrian bridge. These sections were based on standard topographic information (not LiDAR), downstream of cross-section 26.34. The MIKE 11 model used LiDAR data to generate cross-sections in the downstream portions. This difference in input data explains the water level and invert variations downstream of the pedestrian bridge.

The upstream end of the concrete bypass channel is situated at Church Street. During the *Phase 1* study, AMEC completed cross-section survey to characterize the low flow channel (AMEC 2012). This low flow channel within the concrete bypass channel was incorporated in the HEC-RAS model but not in the MIKE 11 model (as discussed in Section 3.2.2.2 the exclusion of the low flow channel was expected to have minimal impacts on the flood event water levels). However, the inclusion of the low flow channel within only the concrete portion of the creek creates an artificial abrupt drop in the invert of the HEC-RAS model at the upstream end of the concrete channel (refer to the yellow line in Figure 28). The impacts of this variation in water levels are discussed in the section below.

4.4.2 Impacts of Low Flow Channel

The abrupt drop in invert elevation and/or the difference in invert elevation within the bypass channel may be responsible for the differences seen in water levels between the HEC-RAS and the MIKE 11 results. Further investigation was undertaken to gain an understanding of these modelled differences at Church Street in order to ensure that the transition of inverts is simulated appropriately the in MIKE 11 model.

Figure 29 demonstrates the typical difference in cross-section between the HEC-RAS and MIKE 11 models within the concrete bypass channel, suggesting that the only significant difference between the modelled sections in this area is the low flow channel. In order to compare the effects of inclusion of the low flow channel, LiDAR-based cross-sections were input to the HEC-RAS model and the 50-year event was rerun.

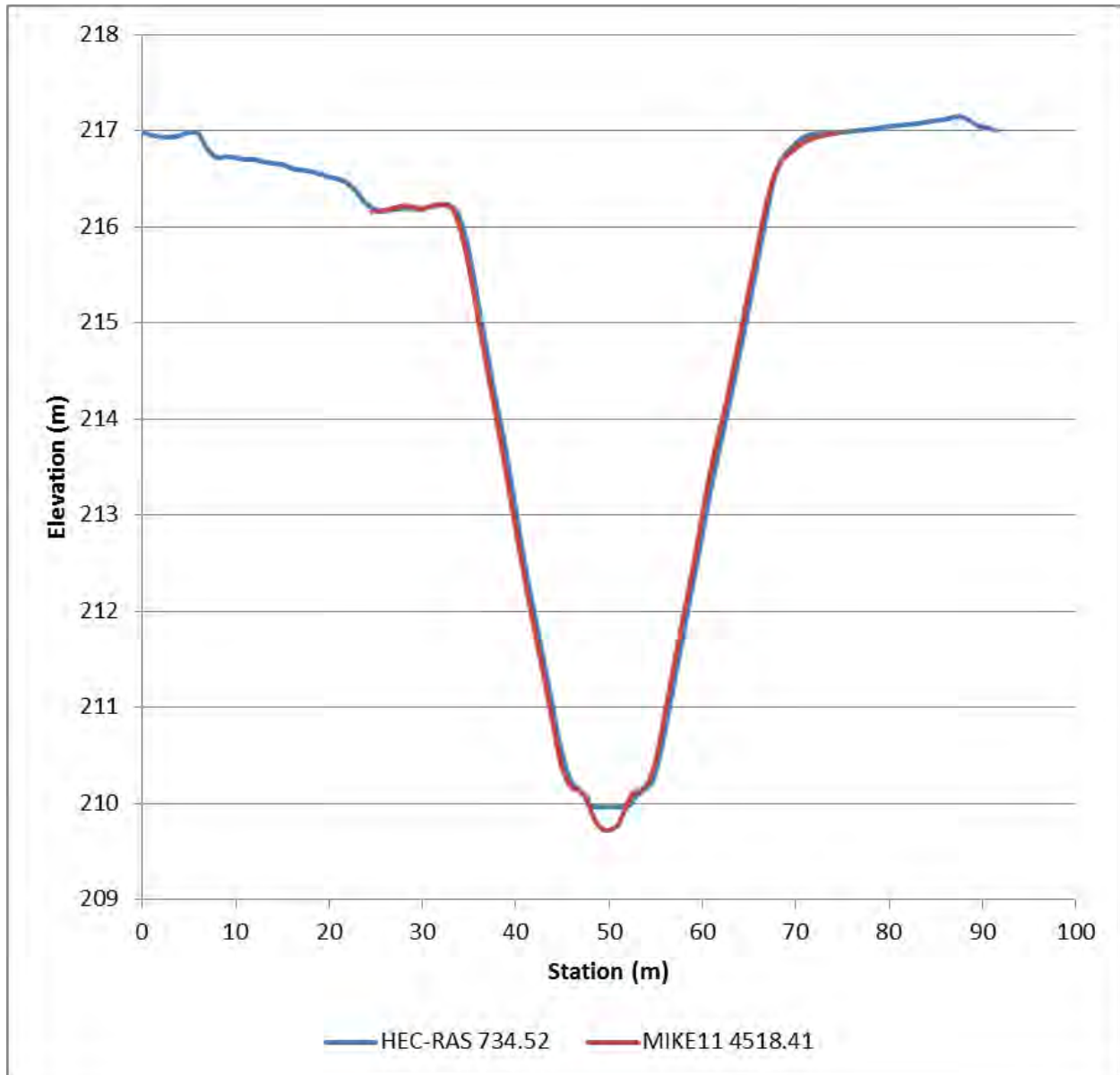

Figure 29 Cross-Section Comparison between MIKE 11 and HEC-RAS

The results of this analysis from the 50-year event are illustrated in Figure 30. This figure shows both the modelled inverts and water surfaces of the HEC-RAS model with the low flow channel, the HEC-RAS model without the low flow channel, and the MIKE 11 model (no low flow). The comparison of the two HEC-RAS model simulations confirms that the inclusion of the low flow channel causes a drop in water surface. Removing the low flow channel in the concrete section (and thus the sudden drop in inverts) results in agreement between the HEC-RAS model and MIKE 11 model upstream of Church Street.

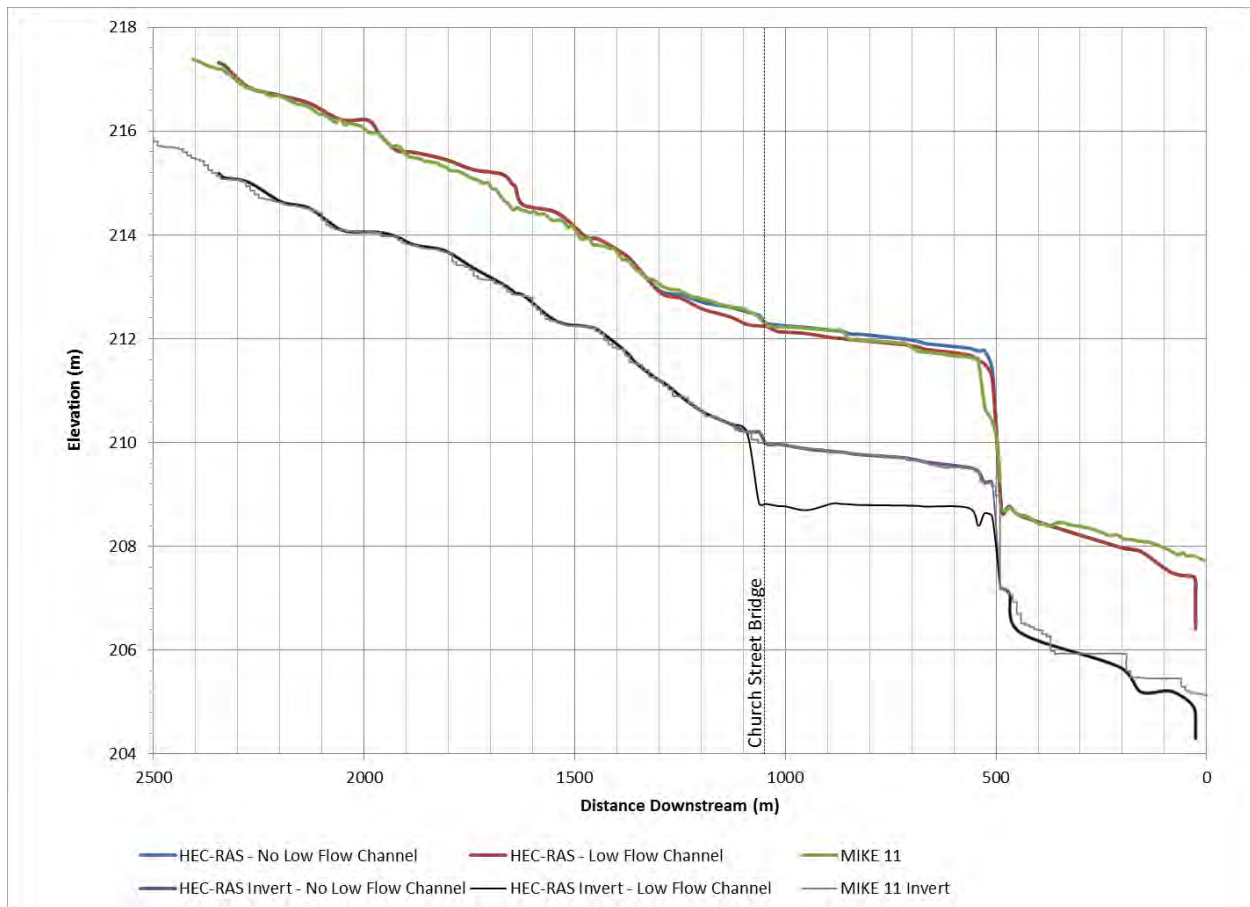

Figure 30 MIKE 11 vs. HEC-RAS Water Levels with and without Low Flow Channel

The aim of this assessment was not to determine or comment on which invert is correct, but rather to understand the causes of the differences between the resulting water elevations. The difference in water surface around Church Street between the two models was determined to be caused by the differences in the low flow channel between the model setups. The maximum difference between HEC-RAS water levels with and without the low flow channel is a decrease of 0.29 m, with an average decrease of 0.19 m. This average difference represents 7% of the total depth in the low flow channel and is therefore considered insignificant. In addition, inclusion of the concrete low flow channel has negligible effects on channel storage. Therefore, the concrete low flow channel does not need to be added into MIKE 11.

5 CHARACTERIZATION OF EXISTING FLOOD RISK

As part of this study Matrix completed the characterization of existing flood risk using the 3-way coupled MIKE FLOOD model over a range of design storm events. The following section summarizes the flood characterization including results of the design storm runs, and identification of flood mechanisms and areas of high, medium, and low flood risk.

5.1 Design Storm Runs

The calibrated existing condition 3-way coupled model was run under a variety of unsteady and steady state hydrologic flow scenarios to establish existing flood risk over a range of design storm events and the Regional Storm, as summarized in Table 14. The run numbers are correlated with the model results which are displayed in Map Sets 1 to 13. In each map set Sheet 1 displays modelling depth, Sheet 2 displays modelled velocity, Sheet 3 displays resultant depth × velocity, and Sheet 4 displays overall flood risk.

The Regional Storm event (Hurricane Hazel) was run in both steady state and unsteady state conditions; these are identified as run numbers 1 and 2, respectively. As discussed in Section 3.2.5.1, the unsteady state hydrographs were prepared as typical hydrographs with a rising limb, peak flow, and falling limb over the selected storm duration. The steady state inflows were prepared as ‘quasi-steady’ whereby the flow was gradually increased over a one hour period to achieve stability. The peak flow was then held constant for the remainder of the simulation time (dependent on design storm) to achieve steady state throughout the study area. As summarized in Table 14, run numbers 3 to 12 were conducted using a 12-hour AES rainfall distribution applied to both the riverine and urban networks. The 12-hour AES was selected because this storm distribution provides the most conservative estimate of peak flows in the riverine system (MMM 2013).

Upon review of the design storm model results, particularly within the downtown urban area, the surface flooding was not as extensive as expected. While there were a number of flooding locations throughout the study area, the limited amount of surface flooding during events in excess of the 10-year design storm for the sewer network raised concern. Typically, the Chicago storm rainfall distribution is used to generate peak flows in urban areas where the peak flows are largely influenced by rainfall intensity as opposed to rainfall depth. The Chicago storm distribution provides much higher peak intensities compared to the AES distribution and therefore typically produces more conservative flooding results in urban drainage systems. Therefore runs 11 and 12 were conducted for the 100-year and 10-year design events, respectively, with a 3-hour Chicago storm on the urban system and steady state peak flow from the 12-hour AES simulation to generate water levels in the riverine system. The results are shown on Map Sets 11 and 12 for the 100-year and 10-year runs, respectively. The 3-hour Chicago storm runs were carried forward for the flood characterization.

Consideration was also given to an ultimate worst-case scenario which includes the major planning event for both the riverine system (Regional steady state) and the urban major system (100-year 3-hour Chicago) occurring simultaneously. Run 13 represents this worst-case scenario, the results of which are shown in Map Set 13.

Table 14 Existing Condition Model Runs

Run No.	Storm Event	Riverine Model		Urban Model	
		Rainfall Distribution	Flow Condition	Rainfall Distribution	Flow Condition
1	Regional	n/a	Steady	n/a	Unsteady
2	Regional	n/a	Unsteady	n/a	Unsteady
3	350-year	12-hour AES	Steady	12-hour AES	Unsteady
4	350-year	12-hour AES	Unsteady	12-hour AES	Unsteady
5	100-year	12-hour AES	Unsteady	12-hour AES	Unsteady
6	50-year	12-hour AES	Unsteady	12-hour AES	Unsteady
7	25-year	12-hour AES	Unsteady	12-hour AES	Unsteady
8	10-year	12-hour AES	Unsteady	12-hour AES	Unsteady
9	5-year	12-hour AES	Unsteady	12-hour AES	Unsteady
10	2-year	12-hour AES	Unsteady	12-hour AES	Unsteady
11	100-year	12-hour AES	Steady	3-hour Chicago	Unsteady
12	10-year	12-hour AES	Steady	3-hour Chicago	Unsteady
13 ⁽¹⁾	“Worst-Case” Event ⁽¹⁾	Regional	Steady	100-year 3-hour Chicago	Unsteady

Notes:

(1) This run is intended to represent a worst-case scenario which includes the major planning events for the river (Regional steady state) and sewer network (100-year 3-hour Chicago) occurring simultaneously. This scenario will be carried forward for assessment of alternative mitigation measures.

For the steady state runs, the riverine system was run in steady state while the urban system utilized unsteady hydrograph input. Based on previous experience with the MIKE URBAN model, steady state inflows can unrealistically overload the sewer network and cause numerical blow-up errors. Numerical blow-up errors are typically a result of instabilities due to too much flow being conveyed from one cell to the next in a given time period and cause the model to crash. Therefore, use of hydrograph input was required to eliminate potential errors, particularly during the larger storm events. The urban system was run under unsteady conditions for all storm events, while the riverine flows were held steady to ensure that the timing of the peak flows in the urban network and the riverine system were simulated to coincide. This flow condition assumption represents the worst-case scenario. Given the intent of the study, we want to ensure the model is conservative in its flow estimates without being unrealistic.

5.2 Flood Characterization

Flood risk characterization and mapping is typically undertaken with consideration of three risk factors: depth, velocity, and depth-velocity product. In accordance with current Ministry of Natural Resources and Forestry (MNRF) practices, the following risk mapping criteria apply (Table 15). Low risk includes areas that are inundated but where vehicular and pedestrian access and egress are still feasible. Medium risk areas do not permit vehicular access and egress, but pedestrian access and egress is possible. High risk areas do not facilitate safe access of any kind. These flood risk criteria were used to develop the flood risk mapping presented as Sheet 4 in each of Map Sets 1 through 13.

Table 15 Flood Risk Criteria

Risk Level	Low	Medium	High *
Depth	≤ 0.3 m	> 0.3 m and ≤ 0.8 m	> 0.8 m
Velocity	≤ 1.7 m/s	≤ 1.7 m/s	> 1.7 m/s
Depth-Velocity Product	≤ 0.37 m ² /s	≤ 0.37 m ² /s	> 0.37 m ² /s

* Exceedance of any one of the criteria results in high risk.

5.2.1 Flood Mechanisms

The integrated model results were reviewed to assess flood conditions in the study area and identify areas at risk due to inadequate or underperforming infrastructure. This includes MIKE 21 results (depth, velocity, and depth × velocity mapping and dynamic result files), MIKE 11 results (longitudinal profiles and cross-sections), and MIKE URBAN results (sewer inflow, surcharge and longitudinal profiles). The flood mechanisms resulting in high, medium, and low flood risk were identified throughout the study area.

During the review of results, the following potential sources and causes of flooding in the urban and riverine environments were considered:

- riverine flooding
 - ✦ infrastructure capacity issues (bridges, culverts)
 - ✦ channel capacity issues (i.e., areas with constrictions, low points in banks)
 - ✦ backwater conditions
- urban flooding
 - ✦ infrastructure capacity issues (sewers, CBs)
 - ✦ overland flow path issues and topographic low points (on private or public lands)
 - ✦ right-of-way conveyance capacity issue
 - ✦ lot drainage issues
- combinations of urban and riverine issues
 - ✦ backwater conditions at outlets propagating issues into the upstream sewer network

The following subsections provide additional detail on the areas within the study area that are affected by each of the identified flood mechanisms.

5.2.1.1 Riverine Flooding

Riverine flooding occurs when water levels of rivers, streams, and creeks rise and overflow their banks, spilling onto adjacent areas. “Conservation Authorities are responsible for determining the hazard from

riverine flooding” (TRCA 2017). Riverine flooding may be caused by a number of mechanisms including structure capacity (i.e., bridges and culverts), channel conveyance capacity, backwater conditions, and combinations thereof.

To determine the potential source of riverine flooding within the study area, bridge capacities and soffit elevations were reviewed and are summarized in Table 16.

Table 16 Bridge Capacity

Bridge	MIKE 11 Chainage	Dimensions [H × W] (m)	Approx. Flow Area (m ²)	Soffit Elev. (m)	Regional Water Elevation (m)	Storm Event Causing Surcharge
Williams Pkwy	2395.52	4.3 × 14.9	52	221.84	222.01	Regional
Vodden St.	3304.92	2.7 × 20.0	39	216.70	217.46	350-year
Church St.	4195.78	4.5 × 21.5	68	214.52	214.50	Regional
Scott St.	4399.75	6.5 × 21.9	102	216.27	213.97	n/a
Queen St.	4553.61	5.6 × 21.7	85	215.28	213.74	n/a
CNR	4719.73	5.3 × 22.3	83	214.73	213.09	n/a
Pedestrian Bridge	4768.00	4.0 × 12.6	47	211.17	211.47	Regional
Clarence St.	5634.86	3.7 × 26.8	72	208.39	209.02	Regional
Main St. (North)	6164.16	4.1 × 51.2	150	208.04	207.78	n/a
Elgin Drive	7053.20	4.6 × 29.5	95	206.20	206.23	Regional
Main St. (South)	7663.89	3.5 × 28.3	81	203.80	204.51	Regional

Channel capacity restrictions may also lead to riverine flooding, in particular low banks which allow flow to spill from the main channel into the floodplain. Channel capacity restrictions are often linked to structure capacity issues.

Review of model results, particularly the worst-case event (Regional Storm event applied to riverine system with 100-year event applied to urban system) reveals a number of locations where flow spills beyond the typical floodplain. One such area is immediately upstream of Church Street where flow spills from the right bank toward Ken Whillans Drive. Flow overtops Church Street at the intersection with Ken Whillans Drive where it then proceeds into the Downtown Brampton SPA 3 through the historic valley corridor. Downstream of the Church Street bridge, flow is contained within the bypass channel (indicated by a dry right bank in the model results on Map Set 13). This suggests that the riverine flooding in this area is caused by a combination of low bank elevations and backwater upstream of Church Street. While the bridge opening area of the Church Street bridge is not particularly small, the soffit elevation is significantly lower than that of the Vodden Street bridge upstream and the Scott Street bridge downstream.

An additional area of focus is the tailwater area located near Mary Street and Moore Crescent. The tailwater area is located at the downstream end of the historic valley corridor, through which water flows during the Regional Storm event. In this area, particularly during the worst-case event, water

elevations in the creek create backwater conditions causing flooding to spill over the right bank and propagate upstream into the residential area.

5.2.1.2 Urban Flooding

Urban flooding includes “street flooding and basement flooding [which] occurs when there is more water than the local drainage system (sewers and streets) can handle, or when there is a lack of a major overland flow route from a low-lying area. Urban storm infrastructure is the responsibility of municipalities” (TRCA 2017). Flood mechanisms causing urban flooding include undersized inlets (i.e., CBs, ditch inlets, etc.), undersized sewers, ill-defined overland flow paths, low-lying areas with no outlet, and combinations thereof.

Assessments of the sewer system capacity were completed including both inlet and sewer pipe capacity. The 10-year 3-hour Chicago storm results were used for this assessment as this is the event typically used for sewer system capacity design. Figure 31 indicates the nodes which experience inlet capacity and/or surcharge issues during the 10-year Chicago event.

Based on the MIKE URBAN modelling, the inlets listed in Table 17 experience diverted runoff during the 10-year Chicago event, meaning they do not have capacity to capture the modelled runoff from the directly connected catchments. A total of 168 nodes experience diverted runoff, representing 12% of nodes in the study area.

The diverted runoff may be caused by a variety of reasons but one possible reason is that all inlets were modelled as single CBs. It is likely that some of these have double inlets or other configurations (i.e. ditch inlets, curb inlets, etc.). A field investigation of these locations was undertaken by City staff to inventory CBs experiencing diverted runoff. The findings of this investigation were incorporated into Figure 31. We recommend that nodes with double CBs be reflected as such in modelling for future studies; model updates will not be done for this study due to schedule constraints and the requirement for field survey. However, we anticipate that field confirmation of inlet types will not significantly impact overall modelling results for the Regional storm event.

Table 17 Nodes with Inlet Capacity Issues

Node ID							
MH_7	CB_59102	CB_29550	CB_31144	CB_28156	CB_19941	CB_1756	CB_12806
MH_34	CB_59101	CB_29511	CB_31143	CB_28154	CB_19940	CB_17556	CB_12801
MH_40	CB_59100	CB_32199	CB_31142	CB_27755	CB_19935	CB_17537	CB_12752
CB_7944	CB_44574	CB_32178	CB_31141	CB_2633	CB_19934	CB_17536	CB_10651
CB_7930	CB_44573	CB_32159	CB_31140	CB_2559	CB_1973	CB_1726	CB_10640
CB_7912	CB_44572	CB_31590	CB_31137	CB_2529	CB_19702	CB_17126	CB_10631
CB_7705	CB_44532	CB_31386	CB_29510	CB_2456	CB_19694	CB_17025	CB_10629
CB_7702	CB_30612	CB_31385	CB_29509	CB_22995	CB_1942	CB_17024	CB_10625
CB_7321	CB_30560	CB_31376	CB_29507	CB_22982	CB_18992	CB_13239	CB_10589

Node ID							
CB_64066	CB_30520	CB_31375	CB_29506	CB_22967	CB_18991	CB_13209	CB_10575
CB_59992	CB_30500	CB_31359	CB_29491	CB_22966	CB_18988	CB_13187	CB_10525
CB_59991	CB_30482	CB_31358	CB_29427	CB_21886	CB_18962	CB_13164	CB_10524
CB_59990	CB_30479	CB_31357	CB_29422	CB_21884	CB_18961	CB_13145	CB_10523
CB_59989	CB_30469	CB_31329	CB_29420	CB_21881	CB_18960	CB_13142	CB_10497
CB_59988	CB_30468	CB_31328	CB_29414	CB_21879	CB_18959	CB_13058	CB_10496
CB_59640	CB_30438	CB_31319	CB_29413	CB_21835	CB_1880	CB_13003	CB_10495
CB_59639	CB_30436	CB_31318	CB_29407	CB_21706	CB_1868	CB_12898	CB_10491
CB_59619	CB_3023	CB_31310	CB_29327	CB_21701	CB_1866	CB_12897	CB_10411
CB_59618	CB_3012	CB_31309	CB_29324	CB_21699	CB_1848	CB_12890	CB_10410
CB_59118	CB_29649	CB_31218	CB_29322	CB_20315	CB_1847	CB_12888	CB_10407
CB_59117	CB_29589	CB_31198	CB_29315	CB_19951	CB_1808	CB_12879	CB_10403

Table 18 lists the nodes that experience surcharge during the 10-year Chicago event. These nodes are discharging excess water from the sewers to the surface, indicating potential sewer capacity issues. A total of 140 nodes experience surcharge, representing 10% of nodes in the study area.

Given that some assumptions were made regarding sewer inverts, as discussed in Section 2.2.2.3, it cannot be confirmed at this time whether sewer capacity is the main cause of node surcharge. Therefore, these locations were identified for further investigation during future studies with a revised minor system following detailed survey of sewer system inverts.

Table 18 Nodes with Surcharge

Node ID							
CB_59619	CB_18959	CB_59988	CB_22966	CB_32199	MH_9046	CB_10625	CB_29505
CB_31137	CB_1726	CB_29324	CB_31376	CB_13164	CB_31142	CB_31357	MH_9098
CB_29327	CB_12744	CB_12879	CB_29511	CB_28156	CB_1808	CB_29509	CB_59100
CB_12857	CB_2632	MH_9021	CB_29510	CB_59640	CB_59639	CB_31318	MH_18279
CB_2633	CB_7705	CB_31198	CB_31140	MH_1066	CB_18992	CB_31358	CB_29550
CB_1880	CB_30469	CB_21835	CB_31143	CB_10626	CB_59991	CB_22982	CB_44573
CB_20021	CB_19702	CB_12801	CB_10629	MH_5525	CB_31310	CB_30500	MH_18317
CB_17025	CB_21879	CB_10574	CB_31141	CB_21881	CB_10411	MH_5489	MH_1
CB_2529	CB_44574	CB_31197	CB_18988	CB_17126	CB_21701	CB_59101	CB_10410
CB_59992	CB_18960	CB_10407	CB_10491	MH_17147	MH_6704	CB_59117	MH_18441
CB_30438	CB_28154	CB_31359	MH_9106	CB_21886	CB_21699	CB_10496	MH_52
CB_32200	CB_59989	MH_1073	CB_31328	CB_10524	CB_29413	MH_1287	MH_9099
CB_7930	CB_32159	CB_10495	MH_10124	CB_10631	CB_7702	CB_59118	MH_11615
CB_12752	CB_22995	CB_31144	CB_22967	CB_29491	MH_5476	CB_29589	MH_5551
CB_12794	CB_30612	CB_2559	CB_44532	CB_21885	CB_10525	CB_19934	MH_50353
CB_31218	CB_10640	CB_19935	MH_5478	CB_21884	CB_1866	MH_50187	MH_17168
CB_32178	CB_18991	CB_10575	CB_30520	CB_21883	CB_31375	CB_31385	
CB_12806	CB_13003	CB_29506	CB_19941	CB_31329	MH_5496	CB_31386	

Overland flow routes collect and convey major flows during storm events in excess of the sewer network (minor system) capacity. Typically municipal rights-of-way are designed to convey these excess flows (major system); however, in some cases these overland flow routes are not well defined or include low-lying areas. In these cases, water is able to pond on roadways and may spill onto private property. The locations listed in Table 19 indicate right-of-way conveyance issues where excess water depth, velocity, and/or the product of depth × velocity (D×V) leads to elevated flood risk.

Table 19 Right-of-Way Conveyance

Location	Risk Level (and Triggering Criteria)		
	Urban: 10-year 3-hour Chicago River: 10-year 12-hour AES	Urban: 100-year 3-hour Chicago River: 100-year 12-hour AES	Urban: 100-year 3-hour Chicago River: Regional Steady
Union Street Underpass	Medium (depth)	High (depth)	High (depth, D×V)
Queen Street Underpass	Medium (depth)	High (depth)	High (depth)
Theatre Lane	Medium (depth)	Medium (depth)	High (depth, D×V)
George Street, between Nelson Street and Wellington Street	Medium (depth)	Medium (depth)	High (depth, velocity, D×V)
Nelson Street, between Union Street and Main Street	Medium (depth)	Medium (depth)	High (depth, D×V)
Mill Street at Nelson Street	Low (depth)	Medium (depth)	Medium (depth)
Elizabeth Street	Low (depth)	Medium (depth)	Medium (depth)
Craig Street, between Mill Street and Elizabeth Street	Low (depth)	Medium (depth)	Medium (depth)
Wellington Street, between Mill Street and Elizabeth Street	Medium (depth)	Medium (depth)	Medium (depth)
Thomas Street, between Market Street and Church Street	Low (depth)	Medium (depth)	Medium (depth)
Fern Street	Low (depth)	Medium (depth)	Medium (depth)

5.2.2 Discussion

The review of flood mechanisms allowed for identification of a number of flood zones within the modelling extents. While the primary focus of this study is the Downtown Brampton SPA 3, other nearby existing flood zones were included to ensure that proposed remediation works do not worsen flooding in these areas. Table 20 provides a list of the identified flood zones, the type of flooding experienced, the primary flood mechanisms, and the risk level for each event. The flood zones are shown on Figure 32 in conjunction with the Regional event model results.

It is important to recognize the anticipated level of service associated with constructed flood infrastructure. In the case of urban-based flooding, where the flood model may identify overland flows in excess of the storm sewer system, the amount of overland flow might well be within expectations of original design. Storm sewers which are typically designed based on a 5 or 10-year storm return period are fully expected to be exceeded during a more infrequent event (e.g. 100 year storm), and thereby force overland flows to the streets. In the case of downtown Brampton, the original design standard for the storm sewer system appears to be met in most cases.

Similarly in the case of the concrete diversion channel for Etobicoke Creek, its original design intent was to pass the 350-year storm. The diversion channel adheres to this design expectation, and is only exceeded by storms greater than this, such as Hurricane Hazel.

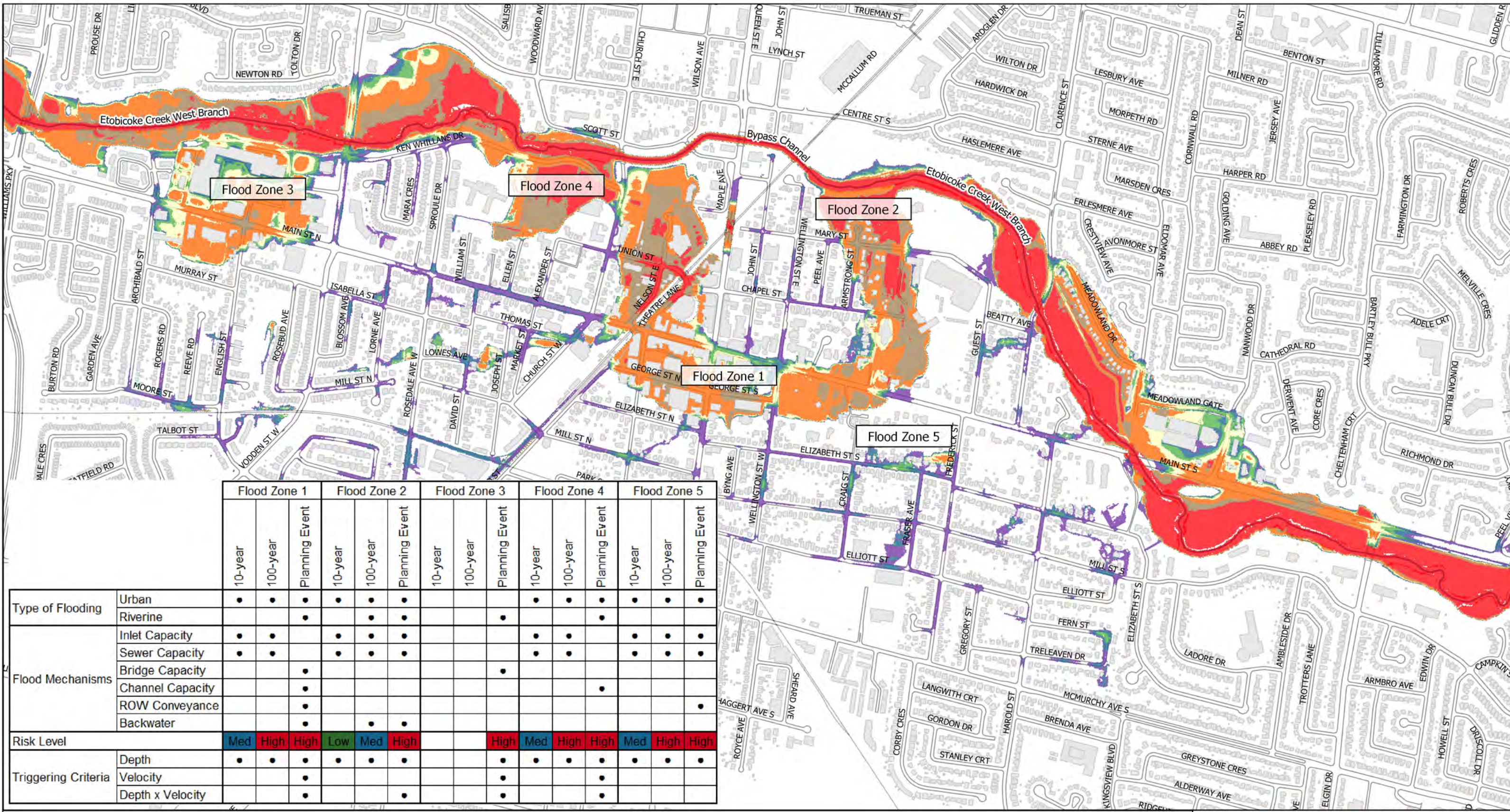

Figure Date: October 2, 2017

Legend

- Watercourse
- Max. Depth (m)
 - 0.50 - 0.80
 - 0.80 - 1.50
 - 1.50 - 2.00
 - > 2.00
- ≤ 0.10
- 0.10 - 0.30
- 0.30 - 0.50



Brampton Integrated Flood Study
Final Report

Project #22062

Flood Zones
Urban: 100-year, Riverine: Regional

Disclaimer: The information contained herein may be compiled from numerous third party materials that are subject to periodic change without prior notification. While every effort has been made by Matrix Solutions Inc. to ensure the accuracy of the information presented at the time of publication, Matrix Solutions Inc. assumes no liability for any errors, omissions, or inaccuracies in the third party material.

K. Molnar
K. Hofbauer
Figure 32

Table 20 Flood Zones

Location	Storm Event	Type of Flooding	Flood Mechanisms	Risk Level (and Triggering Criteria)
Zone 1: Downtown Brampton SPA 3	10-year Chicago	Urban	Inlet capacity Surcharge	Medium (depth)
	100-year Chicago	Urban	Inlet capacity Surcharge	High (depth)
	“Worst-Case” Event	Urban and Riverine	Bridge capacity (Church Street) Channel capacity Right-of-way conveyance	High (depth, velocity, D×V)
Zone 2: Tailwater area of SPA 3 (east of Mary Street)	10-year Chicago	Urban	Inlet capacity Surcharge	Low (depth)
	100-year Chicago	Urban and Riverine	Inlet capacity Surcharge Backwater	Medium (depth)
	“Worst-Case” Event	Urban and Riverine	Inlet capacity Surcharge Backwater	High (depth, D×V)
Zone 3: Kingspoint Plaza	10-year Chicago	n/a	n/a	n/a
	100-year Chicago	n/a	n/a	n/a
	“Worst-Case” Event	Riverine	Bridge capacity (Vodden Street)	High (depth, velocity, D×V)
Zone 4: Ken Whillans Drive and Central Public School Park	10-year Chicago	Urban	Inlet capacity Surcharge	Medium (depth)
	100-year Chicago	Urban	Inlet capacity Surcharge	High (depth)
	“Worst-Case” Event	Urban and Riverine	Channel capacity	High (depth, velocity, D×V)
Zone 5: Elizabeth Street and Frederick Street	10-year Chicago	Urban	Inlet capacity Surcharge	Medium (depth)
	100-year Chicago	Urban	Inlet capacity Surcharge	High (depth)
	“Worst-Case” Event	Urban	Inlet capacity Surcharge Right-of-way conveyance	High (depth)

6 CRITERIA AND BEST PRACTICES FOR FLOOD MITIGATION OPTIONS

A number of criteria and best practices were considered during the development and assessment of the flood mitigation alternatives. A summary of some key considerations are provided here.

6.1 Flood Risk Mitigation Options

There are countless measures that can be implemented to reduce flood risk including everything from education programs for residents to large scale built infrastructure. The provincial guidelines classify measures based on a number of factors. A summary of the classifications is provided below (MNRF 2002).

- permanent vs. non-permanent floodproofing
 - ✦ permanent – always in place, engineered to prevent failure during extreme events including sustained flooding or overtopping
 - ✦ non-permanent – may require operation or maintenance to ensure functionality, or could fail during extreme flood events
- active vs. passive floodproofing
 - ✦ active – requires some action (e.g., closing watertight doors or sandbagging) for the measure to be effective. Advance flood warning is required
 - ✦ passive – always in place and do not require flood warning or any other action to put the flood protection into effect
- dry vs. wet floodproofing
 - ✦ dry – keeps a development and its contents completely dry
 - ✦ wet – undertaken in anticipation of possible flooding while aiming to reduce flood damage to contents, and to reduce the cost of post flood clean up

While any combination of these classifications can help reduce risk, the provincial standards for flood hazard mapping require floodproofing measures to be permanent, passive, and dry. Therefore, in order to remove Downtown Brampton from the Regulatory floodplain, proposed flood remediation measures must adhere to these requirements.

6.2 Flood Protection Landforms

The TRCA is in the process of developing guidelines for the siting and design of structural components for FPLs for the MNRF to endorse these structures as providing permanent protection for use in the design of flood protection landforms within its jurisdiction. The document will focus on geotechnical requirements and will also include development setbacks and acceptable land uses on and adjacent to

the FPL. The following high level design considerations were used to generally establish the FPL footprints for the proposed alternatives:

- the FPL must fully mitigate flood risk to existing flood vulnerable areas (i.e., eliminate Regional Storm spill into SPA 3)
- the FPL must maintain the existing channel conveyance capacity
- the FPL cannot have any unmitigated impact on upstream or downstream water levels
- intrusions into the core of the FPL should be restricted/regulated to preserve the integrity of the FPL (i.e., services, deep rooted vegetation, etc.)
- the elevation of the core of the FPL should allow for 0.5 m of freeboard above the Regional Storm flood level
- fill slopes on the wet side (river side) of the FPL should be 5 to 10%
- fill slopes on the dry side of the FPL should be 1.5 to 2.5%
- the crest width must be 3 to 5 m
- local drainage should be directed away from the FPL
- no hydraulic connection is permitted between the wet and dry sides of the FPL
- no structure or foundation should be supported on or within the FPL
- critical infrastructure should not be located on, in, or beneath the FPL
- development should be set back 10 m from the dry side toe of slope

In order to be considered permanent and passive by MNRF the FPLs must be adequately designed to address all modes of failure such as overtopping, saturation, and boils (TRCA 2016).

“Engineered flood remediation works that qualify as permanent and passive under MNRF guidelines, such as a flood protection landform, would need to meet strict engineering and size criteria in order to remove an area from the Regulatory floodplain. In either case, the remediation works need to be constructed on public lands (or on private lands subsequently placed into public stewardship and control), follow a formal consultative process that respects the rights of all downstream riparian owners, and managed by a public agency with sustainable funding for operations and maintenance before Regulatory flood reduction benefits can be realized. These works will result in floodplain mapping in downstream areas that will show Regulatory flood limits being maintained or reduced.” (TRCA 2016)

6.3 City Road Design Guidelines

The existing Ken Whillans Drive acts as a barrier to flood flow and creates a large ineffective flow area upstream of Church Street. As such, we considered a road realignment option to reconnect the floodplain in this area. The City of Brampton Subdivision Design Manual (City of Brampton 2008) is the local resource for design of road works and civil infrastructure as needed for the proposed alternatives (refer to Section 8 for further details). The standards applicable to this study are summarized as follows:

- roads within the City of Brampton shall be built with an urban cross-section (i.e., with curb, gutter, and storm sewers) with sidewalks on both sides (for collector roads)
- horizontal and vertical control elements conform to the latest edition of Geometric Design Standards for Canadian Roads and Streets (TAC 2017) and include the following (assuming minor collector road):
 - ✦ pavement width 10 m
 - ✦ allowable grade 0.5 to 6.0%
 - ✦ minimum centreline radius 100 m

6.4 Floodplain Conveyance Improvements

Floodplains are natural areas which are flooded periodically during high flow events to dissipate energy. Floodplains provide additional flow area during high flow events thus reducing velocities and water elevations. Flood levels above the banks of the creek typically occur a few times a year (perhaps 2 to 4 times) and mostly in summer. When the flood level within the creek is above the banks, the creek will transport all manners of debris to the floodplain including sediment and loose vegetation.

The floodplain provides a place for a creek to dissipate energy and allows for debris accumulation where water is flowing slowly. However, water velocities in the floodplain are potentially dangerous to people during overbank floods and, particularly in urban areas with high intensity runoff response, can occur very quickly. In many cases historic urban development has encroached on the floodplain thereby reducing the active conveyance capacity of the creek and compromising its functionality during flood events. Numerous cases have been documented that river restoration including removal or setback of infilled embankments allows for restoring more frequent flooding in the floodplain and reduction in flood risk (Golfieri et al. 2017). Because of this, reconnection of the river to its floodplain is considered a best practice.

Within the study area there are three main reaches of the river where historic development has disconnected the river from a functional floodplain.

- Upstream of Church Street, Ken Whillans Drive separates the creek from the west floodplain. This reduces the active conveyance and functionality of the floodplain in this area.
- Within the bypass channel there is no floodplain available.
- Downstream of the bypass channel there are historical landfills within the floodplain that have raised the valley embankments and significantly reduces the floodplain area and associated conveyance capacity.

7 ASSESSMENT OF PHASE 1 ALTERNATIVES

The *Phase 1* study included a HEC-RAS hydraulic assessment of various flood mitigation alternatives and provided short-listed alternative recommendations. The conclusions of the study recognized the limitations of the completed 1D modelling and recommended that future assessments incorporate 2D hydraulic modelling for the study area. That is the basis for the current *Phase 2* study using MIKE FLOOD.

The current study assessed various elements of the short-listed alternatives from *Phase 1*, including the following:

- Tailwater Flood Protection Landform
- Ellen Street Flood Protection Landform
- Lower Bypass Channel
- Combination 2: Ellen Street FPL + Lower Bypass Channel
- Clarence Street Bridge Improvements

Details on the assessments of these alternatives are provided in the subsections below.

7.1 Ellen Street Flood Protection Landform

To assess the impact of the Ellen Street FPL as a standalone alternative, a simulation was completed in MIKE FLOOD. A crest elevation, location, and slope grading for the FPLs was selected during the *Phase 1* study based on the results of the HEC-RAS modelling. However, due to the difference in modelling techniques, it was expected that the flood elevations from the MIKE FLOOD results would be different than that of HEC-RAS. To avoid the need to do multiple iterations of crest elevations, the MIKE FLOOD surface was updated to include a blocked obstruction (i.e., a wall set to 'land value') along the proposed crest location. This setup prevents water from overtopping the crest and allows for choosing an appropriate crest elevation based on the MIKE FLOOD results. Detailed grading of the FPL was not modelled at this time. Further details of this alternative including result mapping are in Appendix F (Preliminary Alternative Assessment, Matrix October 2017).

Compared to existing conditions, the provision of the Ellen Street FPL causes the water elevation to increase by up to 1.0 m between Vodden Street and the downstream end of the bypass channel. The water depth on the wet side (river side) of the FPL is approximately 3.0 m under the Regional Storm event flow conditions. Considering that FPL grading was not incorporated into the model, the actual water elevations could be higher as a result of grading of the wet side of the FPL; however, this provides a good starting point for future combinations with other measures. The identified increase in flood depths upstream of the FPL will need to be mitigated through combinations with other measures (i.e., bridge improvements, channel lowering, etc.) and therefore the Ellen Street FPL is not recommended on its own.

7.2 Lower Bypass Channel

Similar to the Ellen Street FPL, the lowering of the bypass channel was initially assessed as a standalone measure. Consistent with recommendations in the *Phase 1* study, the bypass channel was lowered by 1.5 m from Church Street to its downstream end which is located at the pedestrian bridge crossing in Centennial Park. Matrix notes that the bridges in this modelled scenario were not widened to accommodate the channel lowering. Details of impacts to bridge structures will need to be considered in future studies. Further details of this alternative including result mapping are in Appendix F (Preliminary Alternative Assessment, Matrix October 2017).

The results indicate that lowering the bypass channel will provide notable benefit in the upstream portion of the Downtown Brampton SPA 3 between Church Street and the railway and at the intersection of George Street and Nelson Street (greater than 15 cm decrease in water level in this area). Lowering the bypass channel reduces the water elevation in the bypass channel by up to 1.3 m. However, this reduction in water elevation is localized to the bypass channel and does not propagate upstream of Church Street. There are no changes in water elevations where the spill occurs in North Rosalea Park and therefore channel lowering on its own is not recommended. Instead, we recommend that it be combined with other alternatives to address the spill (refer to sections below).

7.3 Phase 1 Combination 2 (Ellen Street FPL + Lower Bypass Channel)

The results of the two flood mitigation strategies discussed in Sections 7.1 and 7.2 indicate that neither the Ellen Street FPL nor bypass channel lowering alternatives on their own produce the desired reduction in flood levels through the Downtown Brampton SPA 3. As suggested in the *Phase 1* study there is a need to explore combinations of the alternatives to yield more successful overall results.

A MIKE FLOOD model simulation was developed to combine the Ellen Street FPL and the bypass channel lowering as presented in *Phase 1* short-listed Combination 2. As discussed under Section 7.1, the Ellen Street FPL was incorporated in the model through the use of a blocked obstruction to prevent water from overtopping; the actual crest elevation of the FPL was then identified based on the simulation results.

As expected, the results of the combined Ellen Street FPL and lowered bypass channel provide a decrease in flood elevations across the study area. Upstream of Church Street water elevations in the channel decreased by up to 0.70 m. Water depths through SPA 3 have also decreased by up to 1.0 m. The hydraulic modelling of this combined option included the urban network activated in the model. As such, there is a hydraulic connection across the FPL between the river and urban area via the storm sewer outfalls which allows flow to enter the urban area on the dry side of the FPL. The benefits of this alternative are deemed acceptable and therefore it has been carried forward for further analysis. However, considering that one of the requirements of FPLs (refer to Section 6.2) hydraulic connections across the FPL are not permitted. Therefore, in the future analysis, the hydraulic connection across the FPL has been resolved by removing the urban network component from the model simulations. In this

manner, there is no connection between the sewers on either side of the proposed FPL. One option to provide this disconnection is to install flap gates on the sewer outfalls to prevent water from the wet side of the FPL from spilling on the dry side via storm sewers.

7.4 Tailwater Flood Protection Landform

The existing condition flood characterization conducted using the 3-way coupled MIKE FLOOD model (discussed in Section 5) identifies considerable urban flooding within Downtown Brampton. In addition to the known riverine spill upstream of Church Street during the Regional Storm, the flooding is caused by urban sources including sewer backup and inlet capacity restriction during the design storm events. Both the urban flooding and riverine flooding follow the path of the historical river valley through SPA 3, outletting back into the creek in the vicinity of Mary Street and Moore Crescent (see flood characterization Map 13.1).

The dynamic nature of the MIKE FLOOD modelling allows for visualizing flow conveyance from the spill point upstream of Church Street downstream through the SPA as well as how the backwater propagates upstream around Mary Street, which is not apparent from steady state HEC-RAS results. Based on the existing condition MIKE FLOOD dynamic results, the provision of a tailwater FPL would block the outlet of major overland flow to the creek and potentially exacerbate flood risk within the SPA. The current study did not proceed with modelling the tailwater FPL in MIKE FLOOD.

7.5 Clarence Street Bridge Widening

The alternatives discussed in Sections 7.1 to 7.3 are aimed at addressing upstream flood conditions. The FPLs discussed in Section 7.4 was aimed at addressing downstream flood conditions. However, given that the tailwater FPLs would block the local drainage and exacerbate urban flooding, other measures were explored to mitigate downstream flooding.

The latest HEC-RAS model was obtained from TRCA to reassess the impacts of bridges downstream of the study area. This assessment was done in HEC-RAS due to the desired extent (up to 2 km downstream), as the MIKE FLOOD model does not extend far enough downstream. From review of the existing HEC-RAS water level results the Clarence Street bridge and the narrow river valley upstream creates a backwater effect contributing to high flood levels downstream of SPA 3. Additionally, the Main Street (structure ID EC23-3R), Elgin Drive, and Main Street (structure ID EC23-1R) bridges are also contributing to the backwater.

A scenario was assessed in HEC-RAS to review the potential benefits of widening these four bridges by removing them from the model. The outcome of this assessment confirms that widening the Clarence Street bridge reduces water levels at the downstream end of the study area. However, widening structures further downstream does not provide noticeable benefit within the study area. Water levels were reduced locally at each of the bridges downstream of Clarence Street but the reduction did not propagate upstream to the study area.

As a result of this assessment, the Clarence Street bridge widening (*Phase 1* Option A9) is deemed effective and has been carried through in the downstream options presented in Section 8.2.

7.6 Discussion of Phase 1 Alternatives

Neither the Ellen Street FPL (*Phase 1* A3) nor bypass channel lowering (*Phase 1* A5) alternatives on their own produce the desired reduction in flood levels through the Downtown Brampton SPA 3; however, examination of these preliminary results suggest that exploring combinations of the alternatives may yield more successful overall results. This was also recognized in the *Phase 1* study in which combined alternatives were short-listed.

The *Phase 1* study Combination 2 (A3 + A5) was analyzed which includes provision of the Ellen Street FPL in the upstream area combined with lowering the bypass channel by 1.5 m. MIKE FLOOD model results of this alternative suggest that it would reduce flood levels in the creek and prevent spill from occurring upstream of the bypass channel. The reduced flood levels in the creek alleviate surcharging backwater conditions to the urban system and therefore reduce urban flooding within SPA 3. Check valves may be considered for the sewer outlets to the creek to reduce the probability of backwater propagating into the urban drainage system. This alternative concept has been carried forward for further assessment.

The MIKE FLOOD modelling results of the Ellen Street FPL scenario indicate that tailwater conditions near Mary Street and Moore Crescent continue to cause backwater flooding and upstream improvements have no impact on backwater conditions at this location. Therefore, options to reduce the backwater, particularly aimed at reducing water levels in the creek downstream, are required. Based on review of the existing condition MIKE FLOOD results, it became apparent that provision of a tailwater FPL (*Phase 1* A8) will create a barrier preventing urban and overland floodwaters from exiting SPA 3. This option has not been carried forward for further assessment.

To explore additional measures to reduce backwater conditions, a HEC-RAS assessment was completed to assess bridge widening option for downstream tailwater mitigation by removing Clarence Street bridge and downstream bridges in the model. Based on the result, Clarence Street bridge removal produced notable benefits to reduce tailwater in the study area, while removal of bridges further downstream did not. As such, the Clarence Street bridge improvement alternative (*Phase 1* A9) has been carried forward in this study for further assessment in MIKE FLOOD.

8 REFINED FLOOD MITIGATION ALTERNATIVES

Based on the review of the *Phase 1* alternatives, additional mitigation alternatives were developed to address flooding within SPA 3. In particular, provision of an FPL in the upstream area combined with channel lowering would likely reduce spill into SPA 3 as well as reduce water elevations in the bypass channel thereby reducing the amount of urban flooding caused by backwater at the sewer outlets. Also,

options were developed to reduce backwater conditions in the downstream portion of SPA 3 including channel improvements and bridge upgrades.

The following six refined flood mitigation alternatives were considered and modelled including three upstream options and three downstream options:

- Upstream Option A: Ellen Street FPL
- Upstream Option B: Reconnected Floodplain
- Upstream Option C: Bypass Channel Entrance Feature
- Downstream Option 1: Centre Street Landfill Removal
- Downstream Option 2: Centennial Park Landfill Removal
- Downstream Option 3: Removal of Both Landfills

The upstream options were developed to prevent spill of the Regional Storm event into downtown via Church Street. The downstream options were developed to reduce the backwater into the residential area in the vicinity of Moore Crescent. These are the two main mechanisms of flooding within SPA 3.

The differentiation between flooding caused by riverine spill and urban infrastructure is crucial to the accurate definition of the SPA. Urban flooding is generally not to be considered within an SPA definition, unless the flooding can be shown to be directly linked to, and therefore attributed to, riverine-caused flooding. The 3-way integrated model developed in this *Phase 2* study evaluates flooding in the urban (i.e., storm sewers), channel/riverine, and overland flow systems. The overland flow portion of the model will represent and model both riverine floodplain (i.e. the above-bank riverine flows) and also urban-derived flows resulting from too much runoff in the sewer system. The model is useful in that all three of these types of conveyance can interact effectively, thereby providing a true picture and outcome for flood conditions that will be experienced. But at the same time, the 3-way model does not outwardly distinguish which flooding is purely riverine or purely urban. This lack of distinction becomes an issue in defining SPAs, which are based on riverine flows only. It also leads to difficulties in determining the net benefit of the mitigation measures relating to riverine spill conditions only, and to a lesser degree, urban conditions only.

Accordingly a separation of flooding-type and associated individual results is required when determining best ways to mitigate flooding. Separation of flood type is also crucial to properly defining SPAs. Mitigation measures anticipated for further definition in this *Phase 2* project were focused on improvements to the riverine system, not the urban sewer infrastructure. As such, modelling of the refined flood mitigation alternatives was done with and without the MIKE URBAN model activated to provide a more thorough understanding of the riverine hydraulic impact of the various mitigation measures. The inlet capacity and pipe capacity issues otherwise identified during the overall existing flood characterization can contribute to a significant amount of surface flooding.

To ensure that outflow from the urban network was accounted for in the river flows, the MIKE 11 inflow hydrographs were adjusted as appropriate using peak flows extracted from the VO model for the

appropriate subcatchments contributing to each sewer outlet. The result mapping for each of the alternatives discussed below include an outline of the riverine flood extent with the MIKE URBAN model deactivated as well as the ultimate flooding conditions with the urban system activated.

Table 21 summarizes the modelling simulations that were completed and indicates those that included the MIKE URBAN component of the model.

Table 21 Model Simulation Summary

Flood Mitigation Alternative	Completed Model Simulations		
	HEC-RAS	MIKE 11 + MIKE 21 + MIKE URBAN	MIKE 11 + MIKE 21
Upstream Option A Ellen Street FPL		✓	✓
Upstream Option B Reconnected Floodplain		✓	✓
Upstream Option C Bypass Channel Entrance Feature		✓	✓
Downstream Option 1 Centre Street Landfill Removal		✓	✓
Downstream Option 2 Centennial Park Landfill Removal		✓	✓
Downstream Option 3 Removal of Both Landfills		✓	✓
Bypass Channel Manning's n Assessment	✓		
Riverwalk within Lowered Bypass Channel	✓		
Riverwalk Option including Removal of Drop Structures in Bypass Channel	✓	✓	✓
Riverwalk Option without Floodplain Enhancement			✓

Conceptual designs for each of the refined flood mitigation alternatives have been prepared that include detailed grading plans for each (see Appendix H). Grading of the FPLs was done in consideration of the high level design considerations listed in Section 6.1, particularly that the wet side slopes are between 5 and 10%, and dry side slopes are between 1.5 and 2.5%. Road works associated with the upstream options including Ken Whillans Drive realignment and modifications to the Church Street profile are consistent with City of Brampton road design guidelines as listed in Section 6.3.

8.1 Upstream Options

All of the upstream options (i.e. options involving modifications to the upstream portion of the existing diversion channel near Church Street, such that spill through SPA 3 is mitigated) include lowering the bypass channel by 1.5 m from Church Street to the pedestrian bridge. From approximately 180 m

upstream of Church Street (at the property line of 93 Scott Street) to Church Street, all options include proposed lowering of the channel grades to eliminate the need for a drop structure thus allowing for a smooth transition from the existing grade upstream to the lowered bypass channel at Church Street. Maximizing channel capacity is the priority for this study and additional capacity may improve resiliency of the proposed work. However, future studies of mitigation will also be directed consider natural channel design processes at this location so as to not deteriorate existing conditions upstream and downstream of the study area.

A bypass channel lowering (1.5 m) was graded by Matrix (refer to Figure H-14 in Appendix H) and includes extending the 2:1 concrete side slopes of the bypass channel resulting in an additional 6 m of widening at the top. Considering utility and property impacts as discussed at various stages throughout the project, the side on which widening occurs varies along the length of the bypass channel between the left bank, right bank, and split between both banks.

The following sections provide descriptions of each of the proposed upstream alternatives and the associated results. The result discussions are primarily focused on the specific mitigation measure; however, due to the nature of the modelling setup, the benefits associated with the bypass channel lowering are also mentioned as appropriate.

8.1.1 Upstream Option A: Ellen Street FPL

As shown in Figure 33, Upstream Option A includes the Ellen Street FPL as presented in the *Phase 1* study as Alternative A3 Option 3 (AMEC 2016) and presented in Section 7.1 in addition to the channel lowering as discussed under Section 7.2. A crest elevation (215.80 m) and desired slope grading for the FPLs was selected during the *Phase 1* study based on the results of the HEC-RAS modelling. However, due to the difference in modelling techniques used in the present study, it was expected that the flood elevations from the MIKE FLOOD results would be different than that of HEC-RAS. To avoid the need to do multiple iterations of crest elevations, the MIKE FLOOD surface was updated to include a blocked obstruction (i.e., wall set to 'land value') along the proposed crest location. This setup prevents water from overtopping the crest and allows for choosing an appropriate crest elevation based on the MIKE FLOOD results following the model simulation. Surface grading was completed by Matrix (refer to figures H-01 to H-02 in Appendix H) following the model simulation to determine the conceptual footprint of the FPL. This FPL grading was not included in the hydraulic assessment.

The results from the Ellen Street FPL Upstream Option A simulation are provided in Figure 33 for the Regional Storm event. Compared to existing conditions, the Ellen Street FPL in combination with the bypass channel lowering provides up to 0.46 m decrease in water depth in the channel upstream of Church Street, with a corresponding decrease in flood depth upstream of the FPL of up to 0.19 m. While it was anticipated that the flood elevation upstream of the FPL would increase due to the blockage created by the FPL, the channel lowering provides a relief in downstream water levels thereby contributing to an overall reduction in water levels upstream.

Downstream of Church Street the maximum water depth within the bypass channel has increased; however, these increases can be attributed to the fact that the FPL forces flow to stay within the channel as opposed to spilling into SPA 3 thereby increasing depth. Additionally, lowering the bypass channel inherently increases the water depth as the invert is lowered but tailwater elevations remain unchanged. A summary of water depths and elevations at a number of locations is provided in Table 22, which indicates that elevations have not increased substantially. Also, the results in Figure 33 indicate that flow is maintained within the bypass channel and does not spill and therefore, increases in elevation through the bypass channel is deemed acceptable.

Table 22 MIKE 11 Result Summary (without MIKE URBAN) – Upstream Option A

Location	MIKE 11 Chainage	Depth (m)		Elevation (m)	
		Existing	Upstream A	Existing	Upstream A
Upstream of Church Street	4183.44	4.65	6.17	214.71	214.42
Downstream of Church Street	4209.34	4.31	6.00	214.31	214.27
Upstream of Scott Street	4388.41	4.36	6.18	214.17	214.20
Downstream of Scott Street	4408.41	4.06	6.14	213.85	214.20
Upstream of Queen Street	4538.41	4.10	6.22	213.81	214.24
Downstream of Queen Street	4568.41	4.10	6.24	213.75	214.19

The modelled water elevation adjacent to the Ellen Street FPL ranges from 214.55 m to 214.75 m. Allowing for 0.5 m of freeboard, the required FPL core crest elevation would need to be approximately 215.25 m with additional allowance for topsoil, cover, etc. Considering that the modelling did not incorporate the FPL grading at this time, the crest elevation may need to be higher to accommodate grading on the wet side of the FPL; however, this provides a good starting point for future analysis.

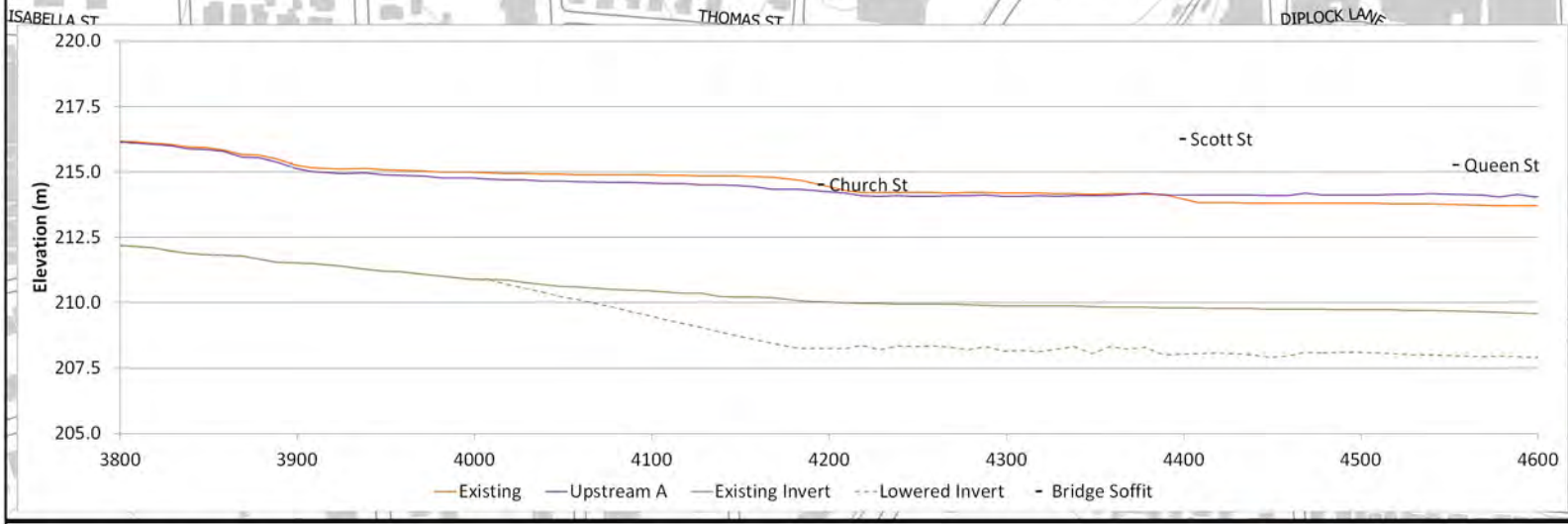
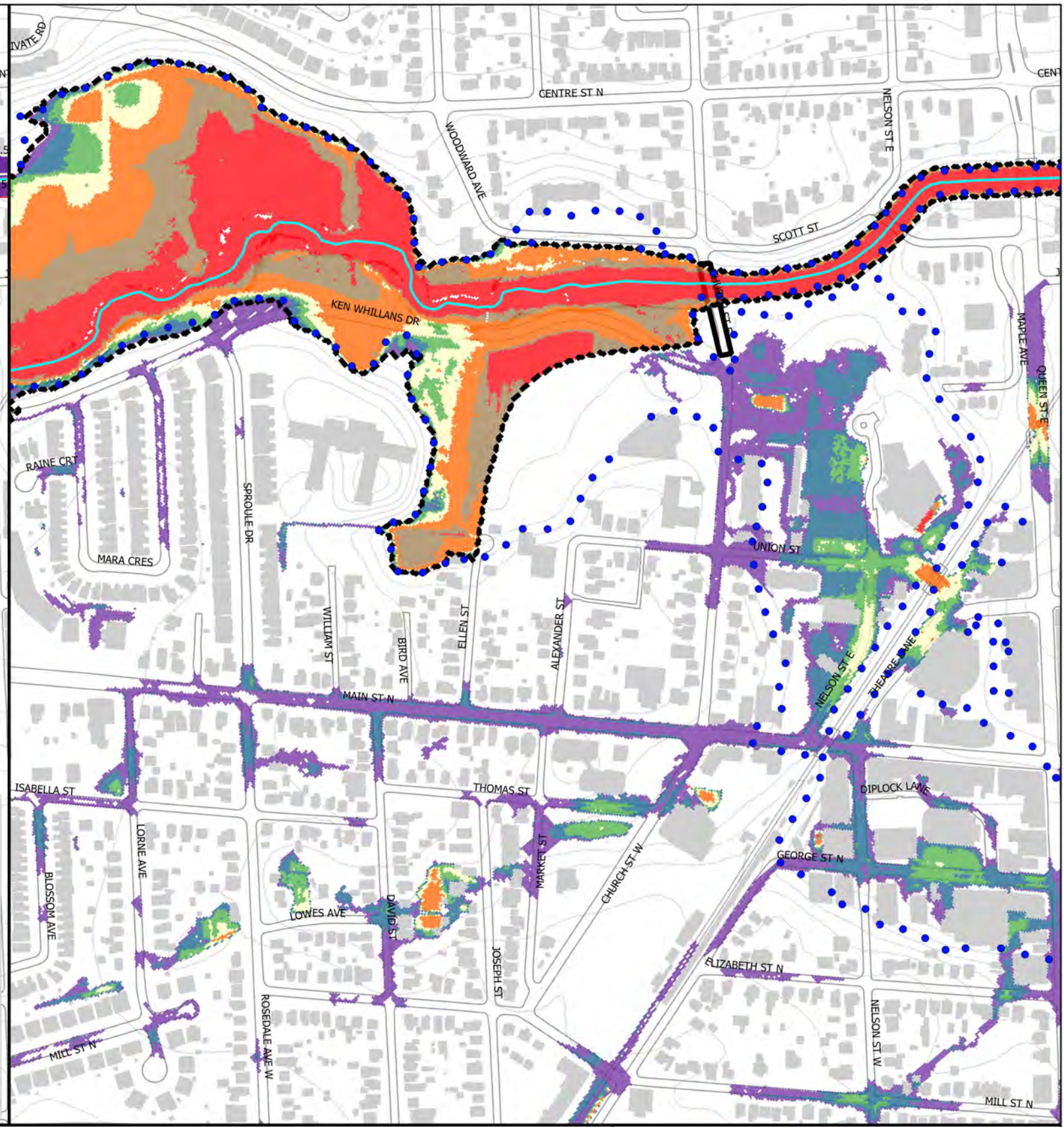
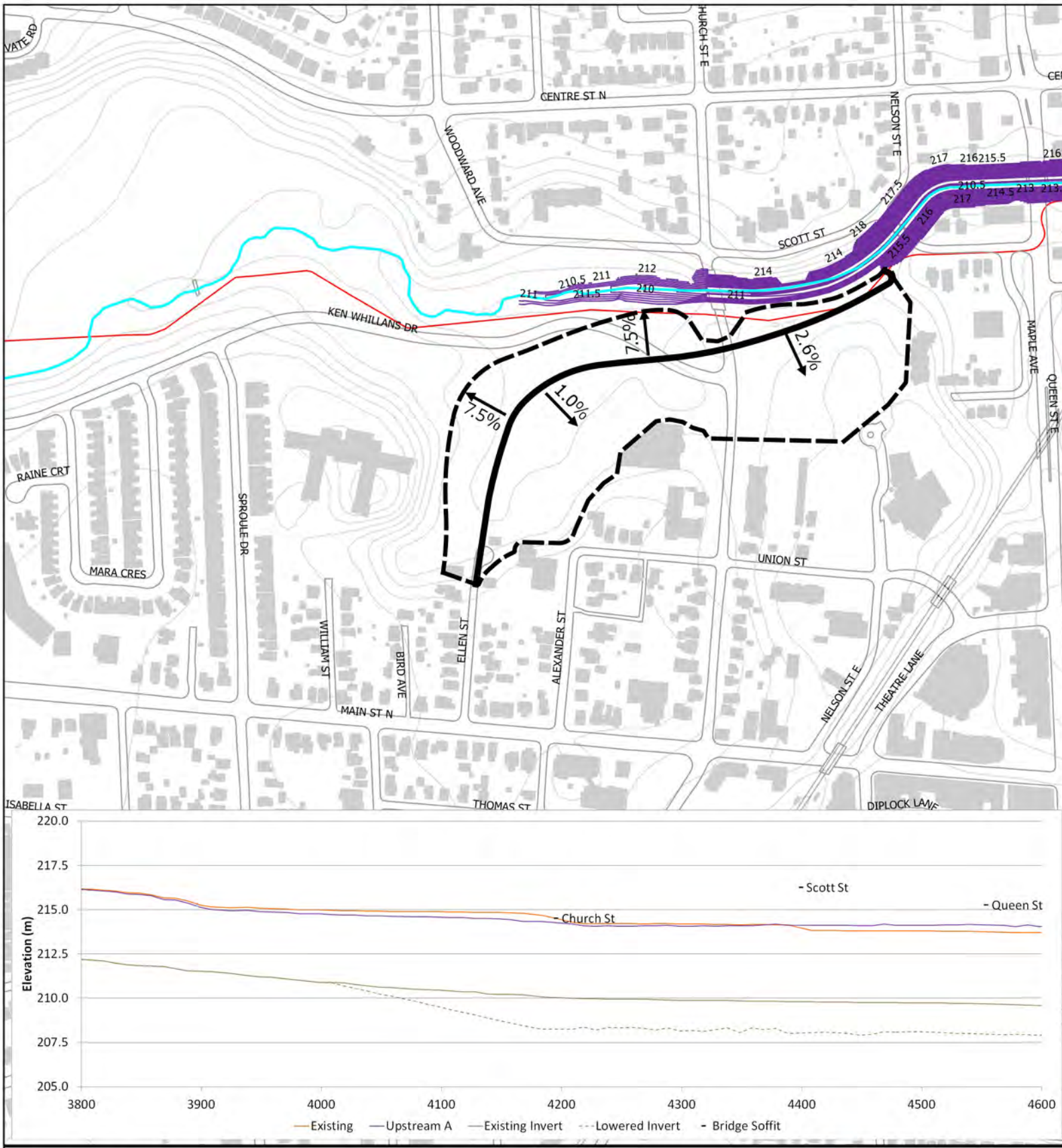

Run Date: December 17, 2017
 Figure Date: December 22, 2017

Note: Proposed alternatives will have impacts on various utilities, most notably the trunk sanitary sewer along the creek. Utility relocation details are to be determined at a later stage.

- Buildings
- Watercourse
- Existing Contours
- Proposed Contours
- Trunk Sanitary Sewer
- FPL Crest
- FPL Footprint
- Max. Depth (m)
- <= 0.10
- 0.10 - 0.30
- 0.30 - 0.50
- 0.50 - 0.80
- 0.80 - 1.50
- 1.50 - 2.00
- > 2.00
- Riverine Flood Extent
- Existing Floodline (2017)

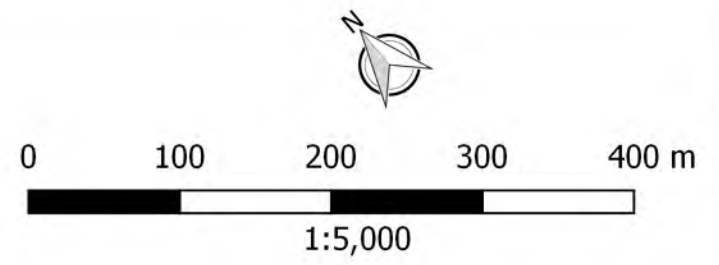

Matrix Solutions Inc.
 ENVIRONMENT & ENGINEERING

Brampton Integrated Flood Study
 Final Report

Project #22062

Upstream Option A Ellen Street FPL
 Urban: 100-year, Riverine: Regional

Disclaimer: The information contained herein may be compiled from numerous third party materials that are subject to periodic change without prior notification. While every effort has been made by Matrix Solutions Inc. to ensure the accuracy of the information presented at the time of publication, Matrix Solutions Inc. assumes no liability for any errors, omissions, or inaccuracies in the third party material.

K. Molnar
 K. Hofbauer

Figure 33

8.1.2 Upstream Option B: Reconnected Floodplain

Refer to Figure 34 for the detailed schematic of Upstream Option B. The existing Ken Whillans Drive acts as a barrier to flood flow upstream of Church Street creating a large ineffective flow area bound by Ken Whillans Drive to the east, the river valley wall to the west, and the Church Street bridge to the south. The proposed Upstream Option B is aimed at removing this ineffective flow area and reconnecting the floodplain in addition to the channel lowering as discussed under Section 8.

Under this option Ken Whillans Drive is realigned to the west to more closely follow the western edge of the valley. Some grading along Church Street will also be required to accommodate the relocated intersection. The conceptual Ken Whillans Drive realignment was graded with consideration for City of Brampton road design guidelines. Additionally, the park area between the proposed Ken Whillans Drive realignment and the creek will be regraded with gentle slopes toward the creek. This option provides connectivity between the park area and the creek by removing the barrier that the existing road presents and also provides opportunities to integrate urban design visions in this area. Refer to figures H-03 to H-05 in Appendix H for detailed grading and figures H-08 to H-10 for plan and profile of the Ken Whillans Drive realignment.

Based on initial model runs, a small amount of spill occurred across Church Street and from the right bank immediately downstream of Church Street. As such, a blocked obstruction was added to the model to prevent spill at these locations as displayed on Figure 34. This allows for determining the elevation to which an FPL would be required without the need for iterative modelling.

The results are shown on Figure 34 including maximum water depth. Note that these results include the modelled blocked obstruction to prevent the spill upstream of Church Street. Compared to existing conditions, reconnecting the floodplain indicates up to 1.79 m increase in flood depth between the realigned Ken Whillans Drive and the creek. However, this increase is expected since the ground elevation was lowered by up to 2.0 m in the vicinity of the existing Ken Whillans Drive alignment. In comparing water elevations, the reconnected floodplain option results in an average decrease in water elevation of 0.29 m upstream of Church Street with localized changes ranging from -0.76 m to 0.15 m.

A summary of water depths and elevations at key locations are provided in Table 23. As previously discussed increases in depth can be attributed to the fact that the reconnected floodplain forces flow to stay within the channel as opposed to spilling into SPA 3 thereby increasing depth through the bypass channel. Additionally, lowering the bypass channel inherently increases the water depth as the invert is lowered but the tailwater elevation remains unchanged.

Table 23 MIKE 11 Result Summary (without MIKE URBAN) – Upstream Option B

Location	MIKE 11 Chainage	Depth (m)		Elevation (m)	
		Existing	Upstream B	Existing	Upstream B
Upstream of Church Street	4183.44	4.65	6.22	214.71	214.47
Downstream of Church Street	4209.34	4.31	6.03	214.31	214.29
Upstream of Scott Street	4388.41	4.36	6.19	214.17	214.21
Downstream of Scott Street	4408.41	4.06	6.15	213.85	214.22
Upstream of Queen Street	4538.41	4.10	6.24	213.81	214.26
Downstream of Queen Street	4568.41	4.10	6.26	213.75	214.21

The modelled water elevation near Church Street is 214.6 m. To prevent road overtopping, the road elevation should be above this elevation. Alternatively, an FPL with a core crest elevation of 215.1 m (to accommodate freeboard) may be provided with the crest following the Church Street alignment.

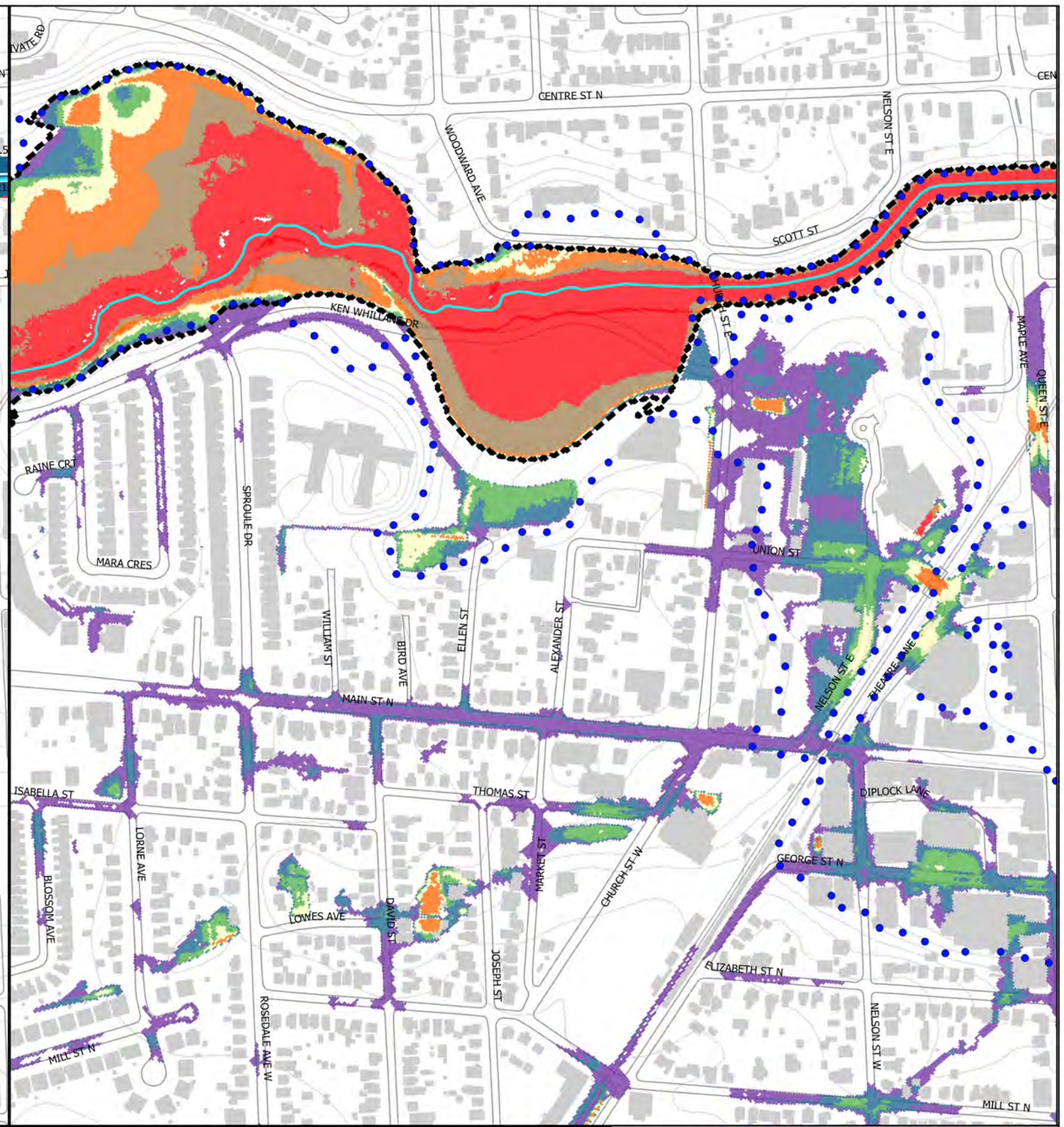
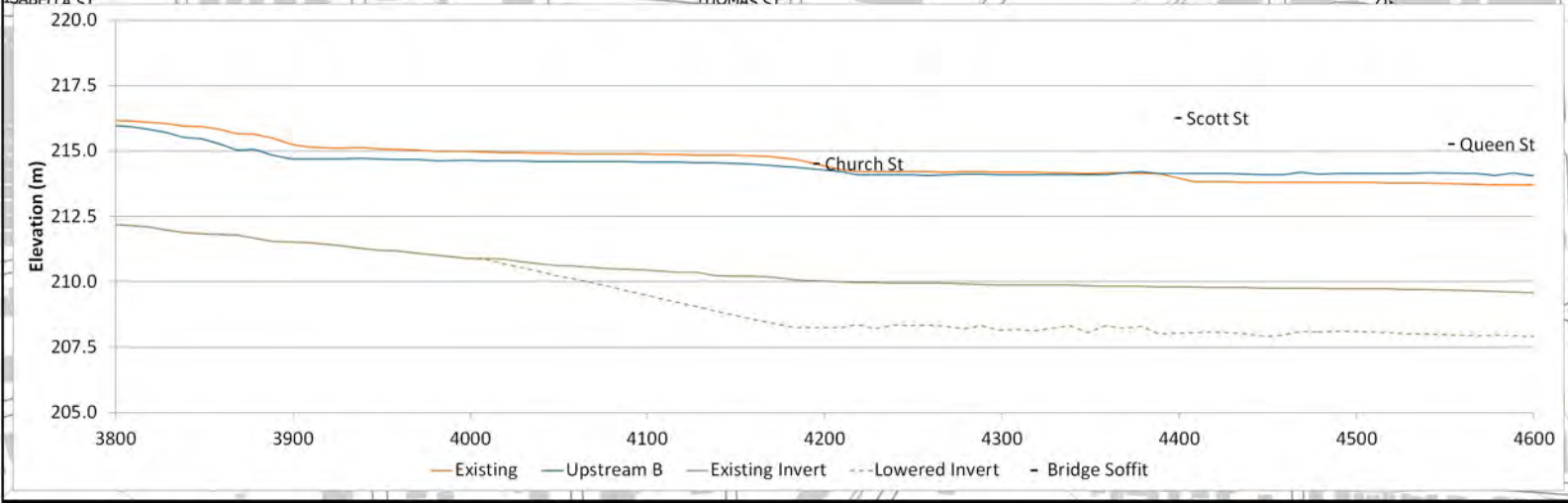
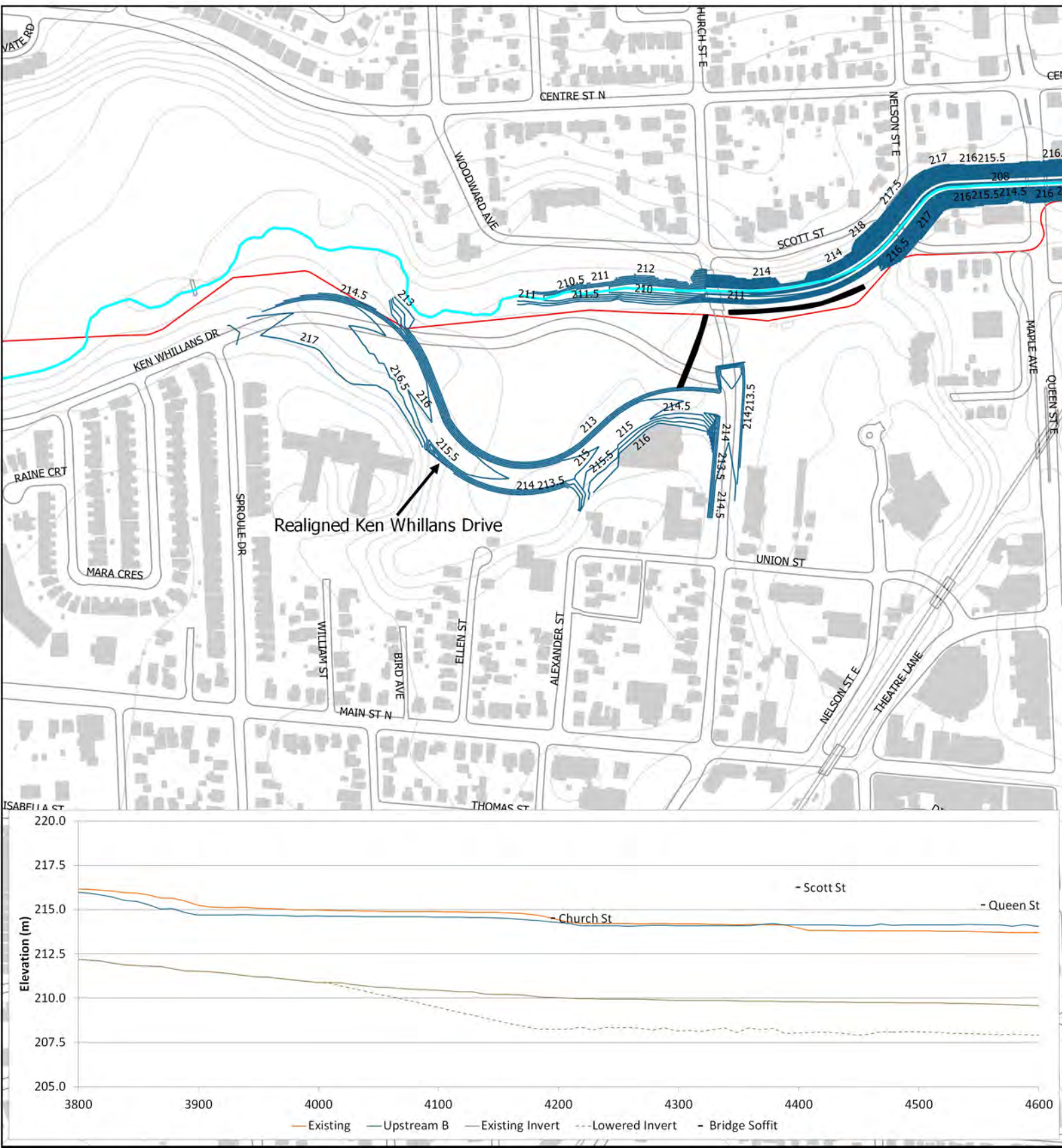

Run Date: December 14, 2017
 Figure Date: December 22, 2017

Note: Proposed alternatives will have impacts on various utilities, most notably the trunk sanitary sewer along the creek. Utility relocation details are to be determined at a later stage.

- Buildings
 - Watercourse
 - Existing Contours
 - Proposed Contours
 - Trunk Sanitary Sewer
 - Modelled Obstruction
- Max. Depth (m)
 - <= 0.10
 - 0.10 - 0.30
 - 0.30 - 0.50
 - 0.50 - 0.80
 - 0.80 - 1.50
 - 1.50 - 2.00
 - > 2.00
 - Riverine Flood Extent
 - Existing Floodline (2017)

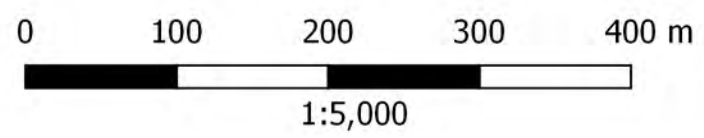

Matrix Solutions Inc.
 ENVIRONMENT & ENGINEERING

Brampton Integrated Flood Study
 Final Report

Project #22062

Upstream Option B Reconnected Floodplain
 Urban: 100-year, Riverine: Regional

Disclaimer: The information contained herein may be compiled from numerous third party materials that are subject to periodic change without prior notification. While every effort has been made by Matrix Solutions Inc. to ensure the accuracy of the information presented at the time of publication, Matrix Solutions Inc. assumes no liability for any errors, omissions, or inaccuracies in the third party material.

K. Molnar
 K. Hofbauer
 Figure 34

8.1.3 Upstream Option C: Bypass Channel Entrance Feature

Refer to Figure 35 for details and results of Upstream Option C. This option expands on the concept discussed in Upstream Option B in which Ken Whillans Drive is realigned to reconnect the Etobicoke Creek floodplain upstream of Church Street. Through review of previous modelling it became evident that the Church Street bridge embankments were creating a significant backwater effect and therefore widening of the bridge through this area will reduce flood elevations. To further enhance the hydraulic performance of the reconnected floodplain provided by relocating Ken Whillans Drive, Upstream Option C includes an FPL shaped such that it redirects any spill flow in the Church Street area back toward the creek through Rosalea Park. This proposed FPL would be located in Rosalea Park south of Church Street (refer to figures H-06 to H-07 in Appendix H). Since initial runs indicated spill around the FPL, a blocked obstruction wall, crossing Church Street west of the new intersection with Ken Whillans Drive, was added to the model to prevent spill. This issue would need to be resolved as part of future studies if this option is carried forward.

The results of the model simulation for this option are shown on Figure 35 including maximum water depth on the surface and within the channel. A summary of changes in water depth and elevation are provided in Table 24. As expected, there are local increases in depth around the existing Church Street bridge. This is because the bridge embankments were removed under this option and therefore the ground elevation has been reduced.

Table 24 MIKE 11 Result Summary (without MIKE URBAN) – Upstream Option C

Location	MIKE 11 Chainage	Depth (m)		Elevation (m)	
		Existing	Upstream C	Existing	Upstream C
Upstream of Church Street	4183.44	4.65	6.54	214.71	214.79
Downstream of Church Street	4209.34	4.31	6.47	214.31	214.73
Upstream of Scott Street	4388.41	4.36	6.19	214.17	214.21
Downstream of Scott Street	4408.41	4.06	6.15	213.85	214.21
Upstream of Queen Street	4538.41	4.10	6.23	213.81	214.25
Downstream of Queen Street	4568.41	4.10	6.25	213.75	214.20

The modelled water elevation in the vicinity of the bypass channel entrance where the proposed FPL is located and along Church Street to the west is 214.66 m. To prevent flow from spilling along Church Street to the west and around the FPL, the road elevation west of the FPL should be above this elevation plus applicable freeboard. This road regrading will require future discussion with the City engineer as part of future studies to review acceptable road grades on Church Street and the associated property impacts. Refer to Figure H-11 in Appendix H for plan and profile of the Church Street works.

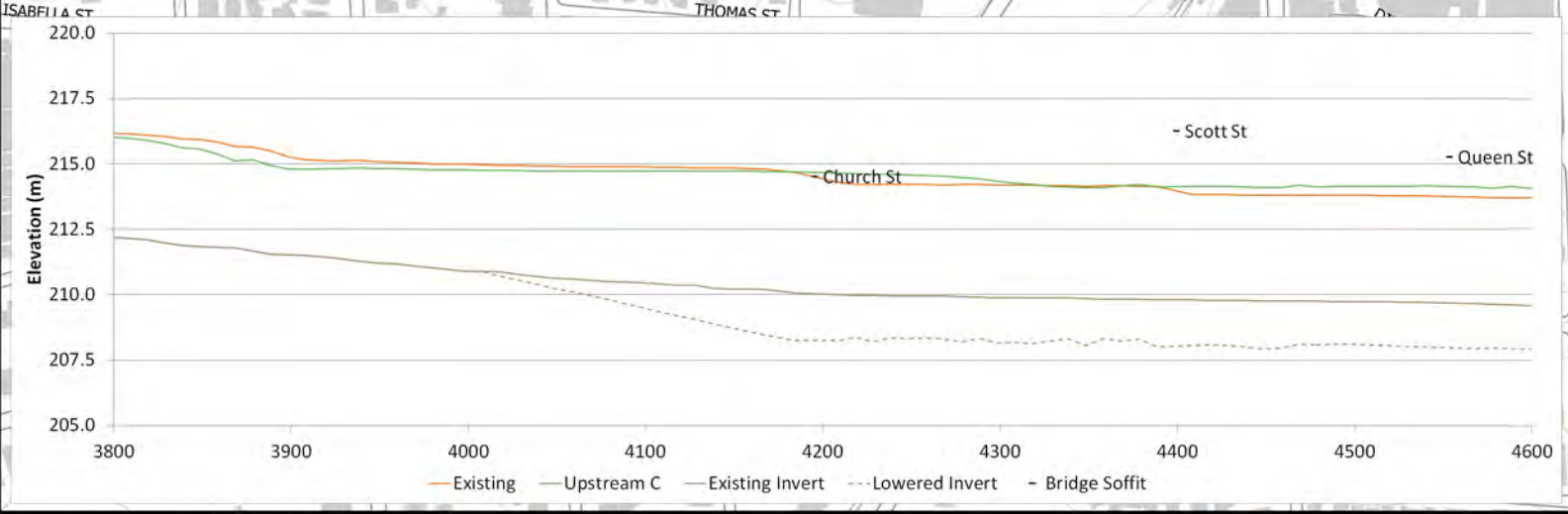
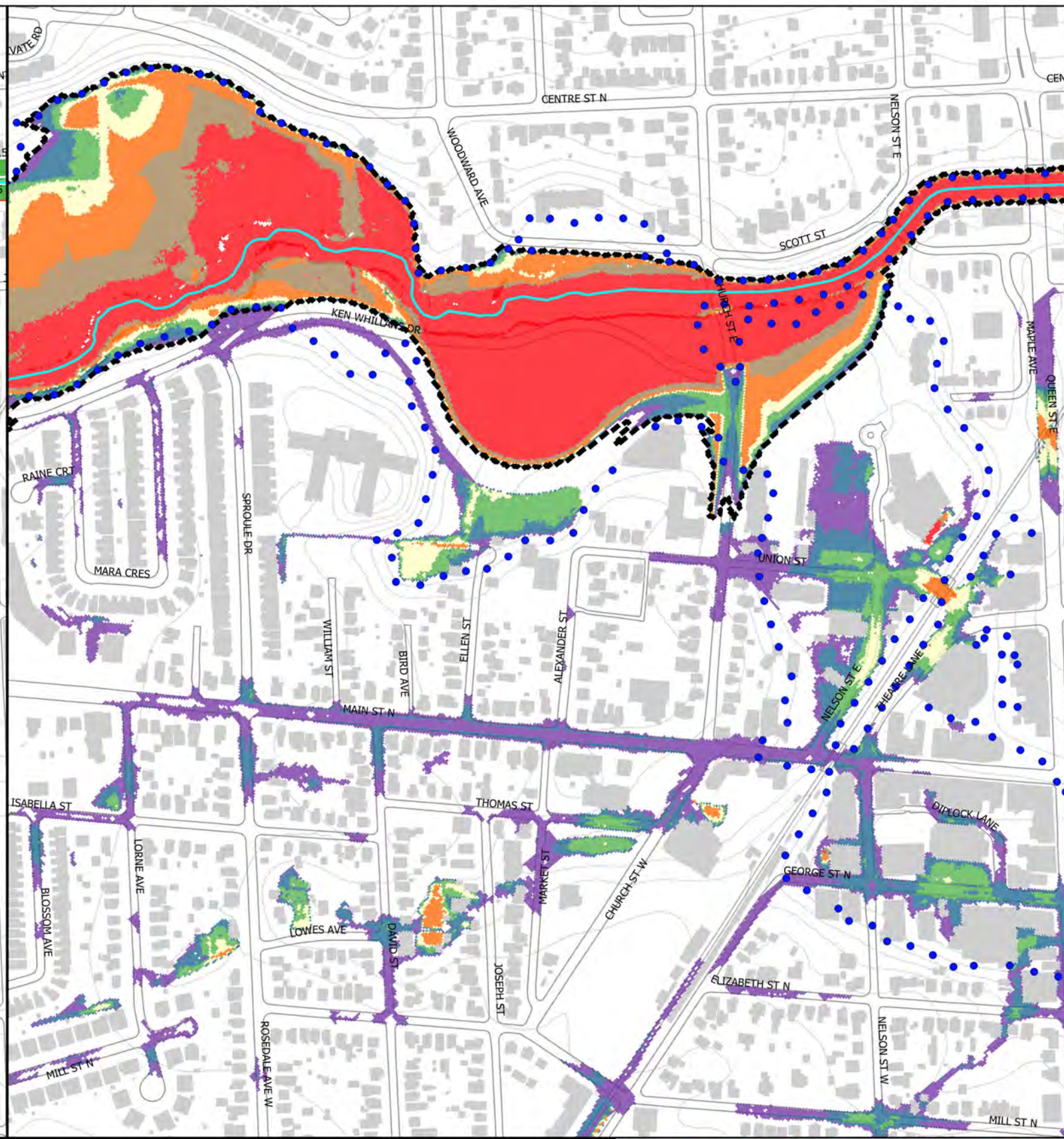
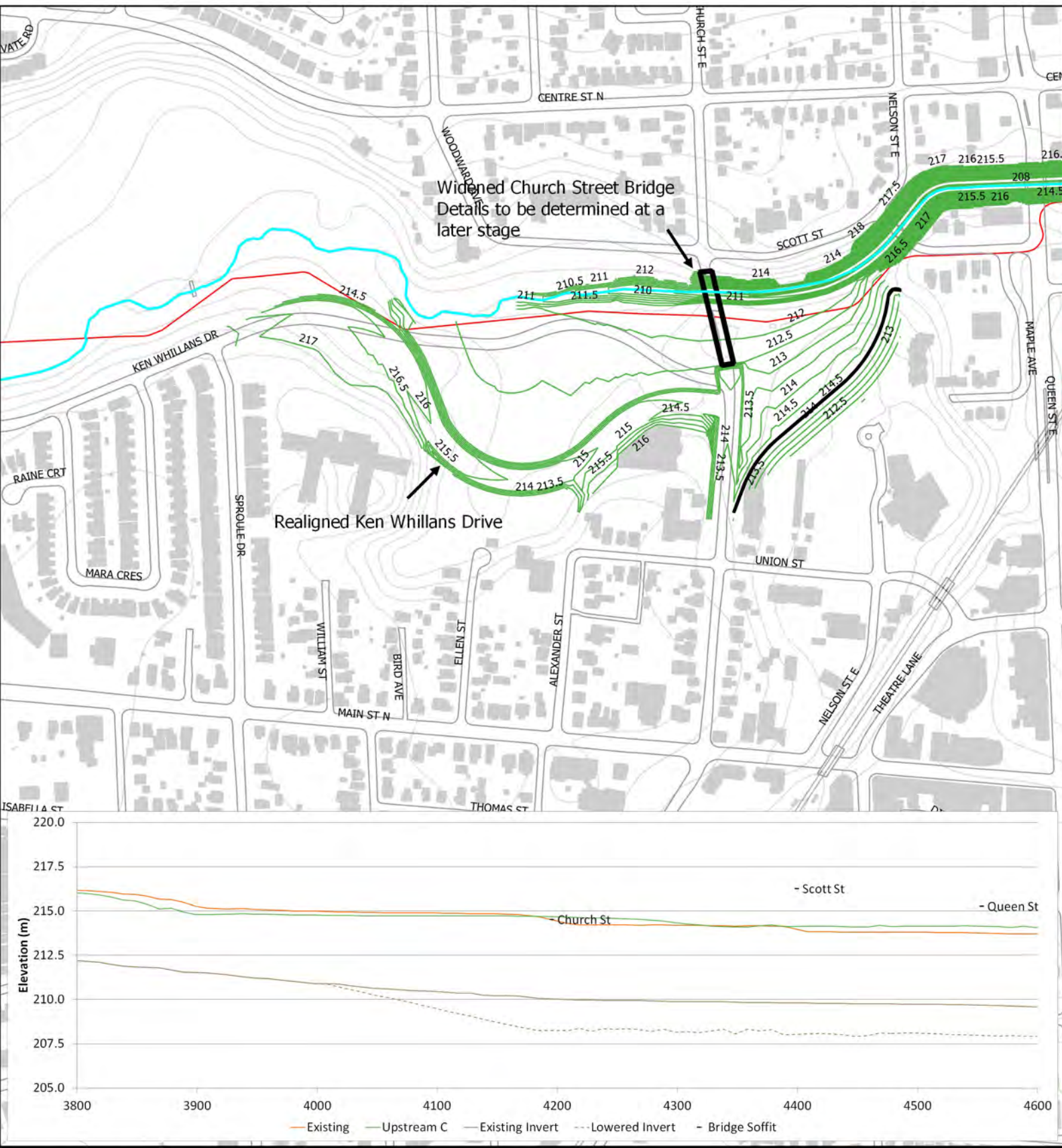

Run Date: December 8, 2017
 Figure Date: December 22, 2017

Note: Proposed alternatives will have impacts on various utilities, most notably the trunk sanitary sewer along the creek. Utility relocation details are to be determined at a later stage.

- Buildings
- Watercourse
- Existing Contours
- Proposed Contours
- Trunk Sanitary Sewer
- FPL Crest
- Max. Depth (m)
 - <= 0.10
 - 0.10 - 0.30
 - 0.30 - 0.50
 - 0.50 - 0.80
- 0.80 - 1.50
- 1.50 - 2.00
- > 2.00
- Riverine Flood Extent
- Existing Floodline (2017)

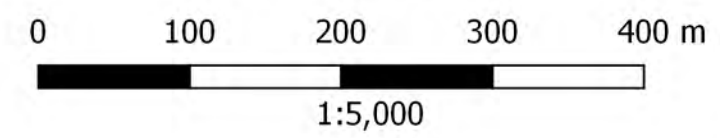

Matrix Solutions Inc.
 ENVIRONMENT & ENGINEERING

Brampton Integrated Flood Study
 Final Report

Upstream Option C Bypass Channel Entrance Feature
 Urban: 100-year, Riverine: Regional

Disclaimer: The information contained herein may be compiled from numerous third party materials that are subject to periodic change without prior notification. While every effort has been made by Matrix Solutions Inc. to ensure the accuracy of the information presented at the time of publication, Matrix Solutions Inc. assumes no liability for any errors, omissions, or inaccuracies in the third party material.

K. Molnar
 K. Hofbauer
 Figure 35

8.2 Downstream Options

All three downstream options (i.e. options meant to mitigate against backwater effects resulting from the existing Etobicoke Creek configuration downstream of the diversion channel) were modelled to include widening of the Clarence Street bridge from 26.8 m to 48 m (*Phase 1 A9*), as review of preliminary model results suggest that this bridge contributes to a significant backwater effect in the study area (refer to Section 7.5).

Additionally, review of preliminary results indicate that the upstream and downstream options are hydraulically separate and therefore various upstream and downstream options were paired and run simultaneously to maximize simulation efficiency. While local works in the upstream and downstream areas have discrete hydraulic benefit, the downstream options were modelled to include the bypass channel lowering and widening. This methodology assumes that the upstream spill has been addressed and all flow is conveyed downstream through the bypass channel. Without this assumption, the downstream recommendations would not be adequately sized to handle the Regional Storm flows, nor would their benefits be successfully assessed, since spill from the channel upstream reduces the peak flows in the bypass channel.

The following sections provide descriptions of each of the proposed downstream alternatives and the associated results. The result discussions are primarily focused on the specific mitigation measure; however, due to the nature of the modelling setup, the benefits associated with the Clarence Street bridge widening are also mentioned, as appropriate, since the Clarence Street bridge widening was incorporated into all three downstream options.

8.2.1 Downstream Option 1: Centre Street Landfill Removal

Refer to Figure 36 for details and results of Downstream Option 1. There is an existing historical landfill on the east bank of Etobicoke Creek south of the CN Railway known as the Centre Street landfill. Based on review of grades in this area in combination with preliminary hydraulic modelling results, this landfill presents a minor pinch point in the river valley as compared to upstream and downstream reaches thereby contributing to backwater conditions upstream. Downstream Option 1 includes removal of the Centre Street landfill and regrading the lands to increase the available floodplain area. The proposed grades will be reduced by up to 3 m within the landfill area.

There is also an existing park situated on top of the Centre Street landfill including tennis courts, soccer fields, a playground, and trail system. The proposed grading plan (refer to figures H-12 and H-13 in Appendix H) allows for maintaining the existing tennis courts, though relocations of other facilities will be required. Note that pending confirmation of City and TRCA standards, these uses may be permitted within the new floodplain area. The grading was completed such that there is a 10 m buffer between the rear yards backing onto the east bank and the proposed grading; no impact to private property was assumed for the hydraulic assessment.

Grading works and mitigation at this location will also require consideration that a *Reach Management Strategy* be implemented by TRCA. This type of strategy includes a long term, in-perpetuity approach to actively managing the condition of the lands such that their hydraulic floodplain characteristics are maintained. A *Reach Management Strategy* differs significantly from a passive approach to managing floodplain lands whereby areas might or might not be targeted for naturalization. The key to an effective Reach Management Strategy is ongoing preservation of hydraulic characteristics, to preserve roughness through active vegetation management and associated activities. Otherwise, a backwater condition could develop in the valley/floodplain from a change (i.e. increase) in roughness over time.

The results of Downstream Option 1 are shown on Figure 36 including maximum water depth in the floodplain and within the channel. As anticipated, due to the lowered grades in the floodplain on the east bank, water depths in this area increased by an average of 2.4 m; however, the extent of spill has not increased significantly and is maintained within City-owned lands. No impact to residential properties along the east bank will occur. Compared to existing conditions, removal of the Centre Street landfill does not provide significant benefit to reduce flood extent within the downstream portion of SPA 3. Backwater conditions propagate upstream to Gage Park with a maximum water elevation of 210.82 m. There is a notable decrease in water depths through SPA 3 ranging between a 0.32 m and 1.03 m reduction in water depth. However, a significant portion of this mitigation is due to the eliminated spill upstream; the reduction in backwater resulting from the Centre Street landfill is a lesser contributing factor.

A comparison of water depths and elevations within the creek are provided in Table 25 to quantify the reduction in backwater effect. As shown, the Centre Street landfill removal shows a maximum decrease in water level of 0.55 m; however this decrease is primarily limited to the 1D channel due to its location. Other considerations related to removal of the Centre Street landfill are discussed in detail in the waste delineation report (WSP 2018). Due to the limited hydraulic benefit shown by this option, removal of the Centre Street landfill on its own is not further assessed.

Table 25 MIKE 11 Result Summary (without MIKE URBAN) – Downstream Option 1

Location	MIKE 11 Chainage	Depth (m)		Elevation (m)	
		Existing	Downstream 1	Existing	Downstream 1
Upstream of CN Rail	4712.23	4.29	6.28	213.70	214.17
Downstream of CN Rail	4729.09	3.18	5.46	212.43	213.14
Adjacent to Moore Street	4938.41	5.34	4.84	211.27	210.77

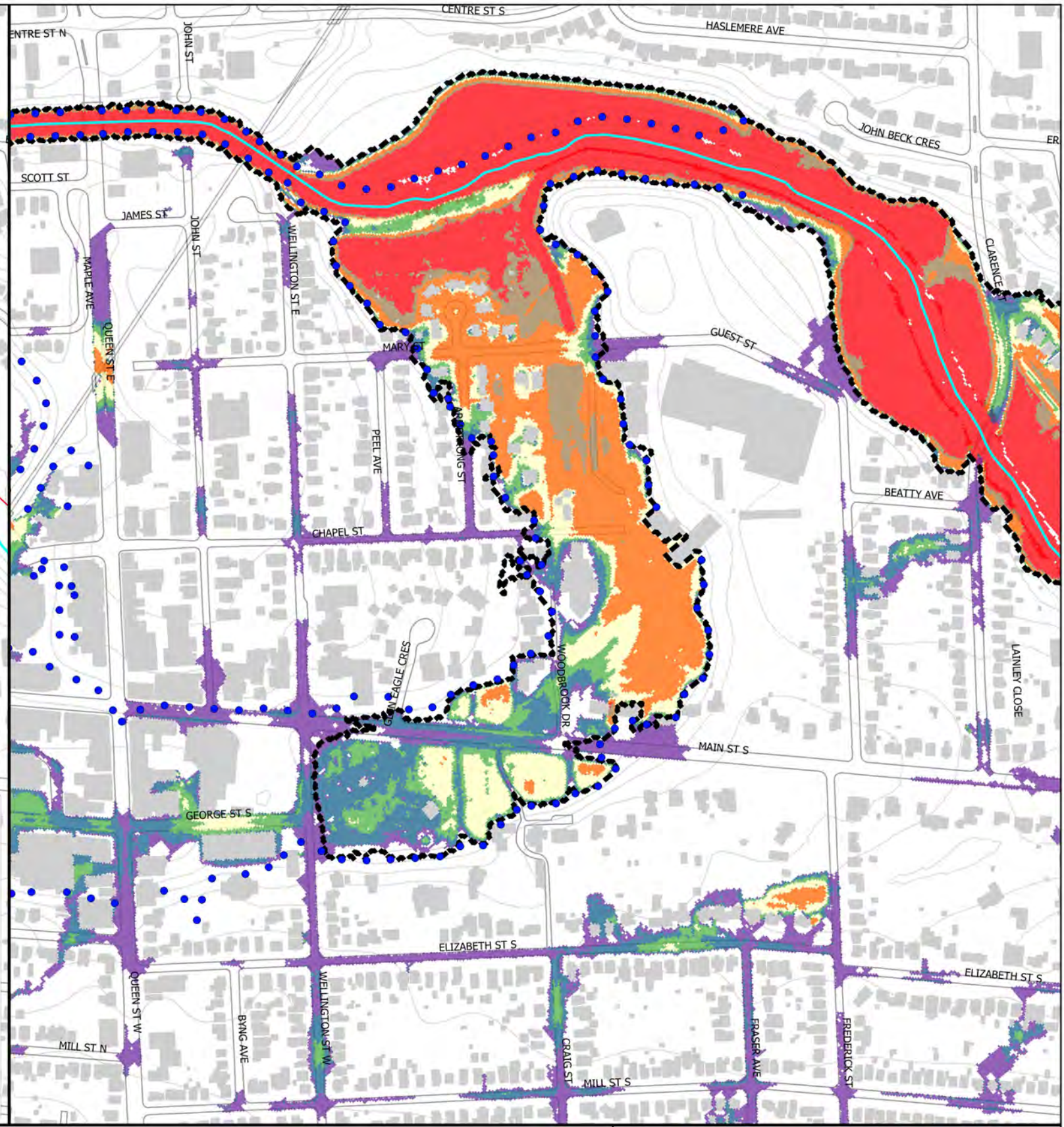
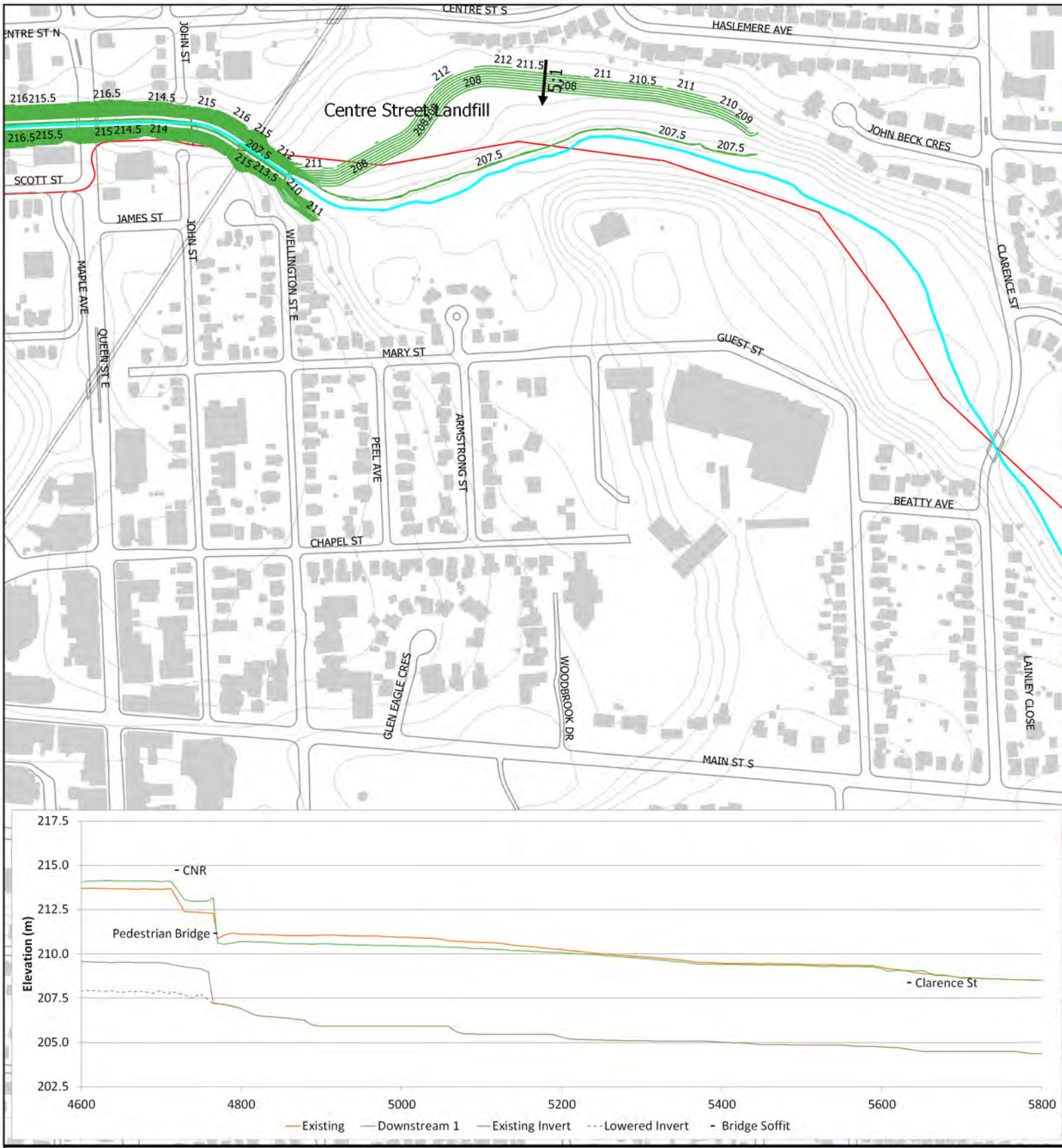

Run Date: December 17, 2017
 Figure Date: December 22, 2017

Note: Proposed alternatives will have impacts on various utilities, most notably the trunk sanitary sewer along the creek. Utility relocation details are to be determined at a later stage.

- Buildings
- Watercourse
- Existing Contours
- Proposed Contours
- Trunk Sanitary Sewer
- Max. Depth (m)
 - <= 0.10
 - 0.10 - 0.30
 - 0.30 - 0.50
 - 0.50 - 0.80
- 0.80 - 1.50
- 1.50 - 2.00
- > 2.00
- Riverine Flood Extent
- Existing Floodline (2017)

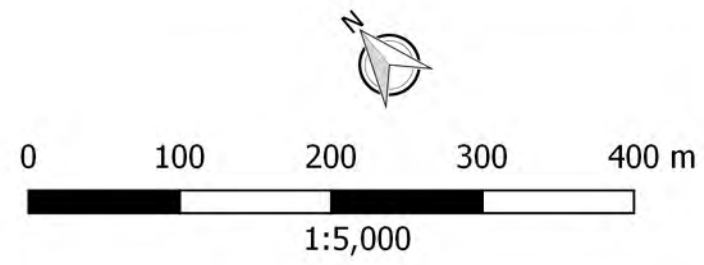

Matrix Solutions Inc.
 ENVIRONMENT & ENGINEERING

Brampton Integrated Flood Study
 Final Report

Project #22062

Downstream Option 1 Centre Street Landfill Regrading/Removal
 Urban: 100-year, Riverine: Regional

Disclaimer: The information contained herein may be compiled from numerous third party materials that are subject to periodic change without prior notification. While every effort has been made by Matrix Solutions Inc. to ensure the accuracy of the information presented at the time of publication, Matrix Solutions Inc. assumes no liability for any errors, omissions, or inaccuracies in the third party material.

K. Molnar
 K. Hofbauer

Figure 36

8.2.2 Downstream Option 2: Centennial Park Landfill Removal

Refer to Figure 37 for details of Downstream Option 2. There is an existing historical landfill on the west bank of Etobicoke Creek west of Mary Street/Guest Street known as the Centennial Park landfill. Similar to the discussion provided above, based on review of grades in this area in combination with preliminary hydraulic modelling results this landfill presents a significant pinch point in the river valley causing a backwater effect upstream. This backwater effect contributes to the tailwater condition and flooding through the downstream portion of the SPA. In comparison to the valley width immediately downstream of the landfill (approx. 260 m), the width of the valley adjacent to the Centennial Park landfill is 130 m. Review of the existing water elevation profile in this area confirms that this constriction causes an increase in water elevation upstream of the landfill.

Downstream Option 2 consists of removing the Centennial Park landfill and regrading the lands to increase the available floodplain area. The proposed grades (refer to figures H-12 and H-13 in Appendix H) will be reduced by up to 7 m. Sitting atop the Centennial Park landfill is Royal Canadian Legion Branch 15 and its associated lawn bowling facility. The regrading works proposed under this option would require removing/relocating these facilities.

Maximum depth results for Downstream Option 2 are shown on Figure 37. Compared to existing conditions, removal of the Centennial Park landfill in combination with the Clarence Street bridge widening provides significant benefit to flooding within the downstream portion of SPA 3; backwater conditions only propagate approximately 375 m upstream to Main Street with a maximum water elevation of 209.87 m west of Mary Street. There is also a significant decrease in water depths through SPA 3, ranging between a 0.69 m and 1.5 m reduction in water depth. The decreases in water depths through the downstream portion of SPA 3 are primarily due to the Centennial Park landfill removal and the associated reduction in backwater resulting from the pinch point that the Centennial Park landfill creates. Note that the eliminated spill upstream is a lesser contributing factor.

A summary of channel depths and elevations are provided in Table 26. The channel depth is reduced by up to 1.0 m downstream of the pedestrian bridge; however, the reduction is diminished downstream with minimal changes immediately upstream of Clarence Street. The Clarence Street bridge is still submerged indicating that the 48 m bridge span is likely not large enough to convey the flows at this location. Additional study is required to determine the ultimate bridge span.

Table 26 MIKE 11 Result Summary (without MIKE URBAN) – Downstream Option 2

Location	MIKE 11 Chainage	Depth (m)		Elevation (m)	
		Existing	Downstream 2	Existing	Downstream 2
Upstream of CN Rail	4712.23	4.29	6.28	213.70	214.17
Downstream of CN Rail	4729.09	3.18	5.36	212.43	213.05
Adjacent to Moore Street	4938.41	5.34	4.48	211.27	210.42

Due to the significant reduction in grade elevations in the floodplain on the west bank, water depths in this area increase locally by an average of 0.14 m; however, this is expected and does not extend into privately-owned lands.

The grading plan for Downstream Option 2 maintains a buffer between Guest Street and the top of the proposed valley; in doing so, the entire landfill has not been removed. Other considerations related to removal of the Centennial Park landfill are discussed in detail in the waste delineation report (WSP 2018). It is anticipated that additional fill removal will not provide a significant additional benefits to the flood risk reduction presented herein; however, this should be explored in further detail during the future EA stage.

8.2.3 Downstream Option 3: Removal of Both Landfills

This option is a combination of Downstream Options 1 and 2 in which both landfills are proposed for removal. This option creates a channel valley similar in size to the downstream reaches. Refer to Figure 38 for details and results of Downstream Option 3 (refer to figures H-12 and H-13 in Appendix H for plan and profile drawings).

The results of Downstream Option 3 are similar to that of Downstream Option 2, with a significant reduction in water levels in the downstream portion of SPA 3 ranging from 0.90 m to 1.5 m reductions in water depth. The channel depth and elevations are provided in Table 27. Depth is reduced by up to 1.10 m downstream of the pedestrian bridge; however, the reduction is diminished downstream with minimal changes immediately upstream of Clarence Street. Similar to Downstream Option 2, the 48 m Clarence Street bridge is submerged. Additional study is required to determine the ultimate bridge span.

Further details are provided in the waste delineation report (WSP 2018).

Table 27 MIKE 11 Result Summary (without MIKE URBAN) – Downstream Option 3

Location	MIKE 11 Chainage	Depth (m)		Elevation (m)	
		Existing	Downstream 3	Existing	Downstream 3
Upstream of CN Rail	4712.23	4.29	6.29	213.70	214.18
Downstream of CN Rail	4729.09	3.18	5.45	212.43	213.13
Adjacent to Moore Street	4938.41	5.34	4.28	211.27	210.21

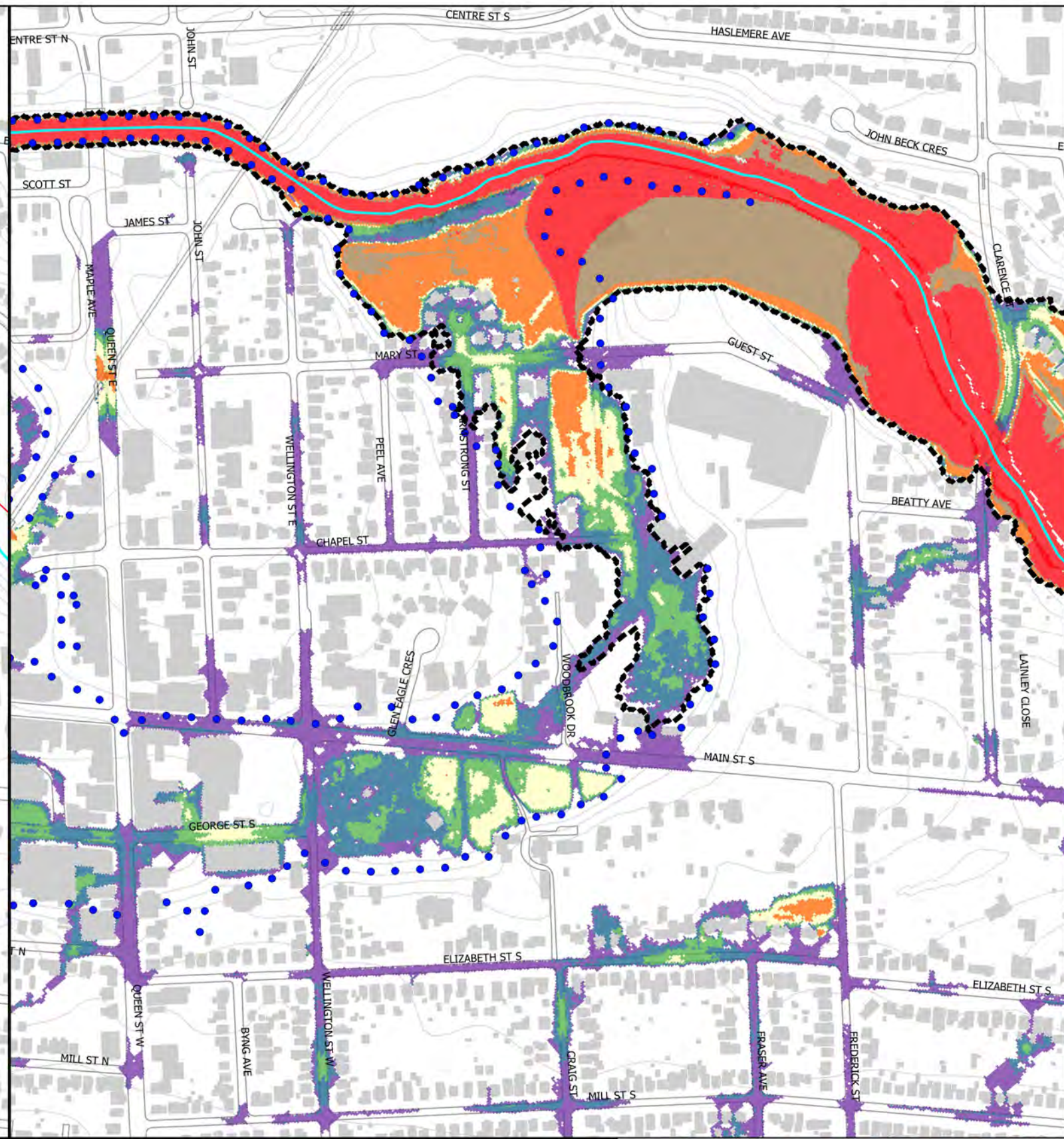
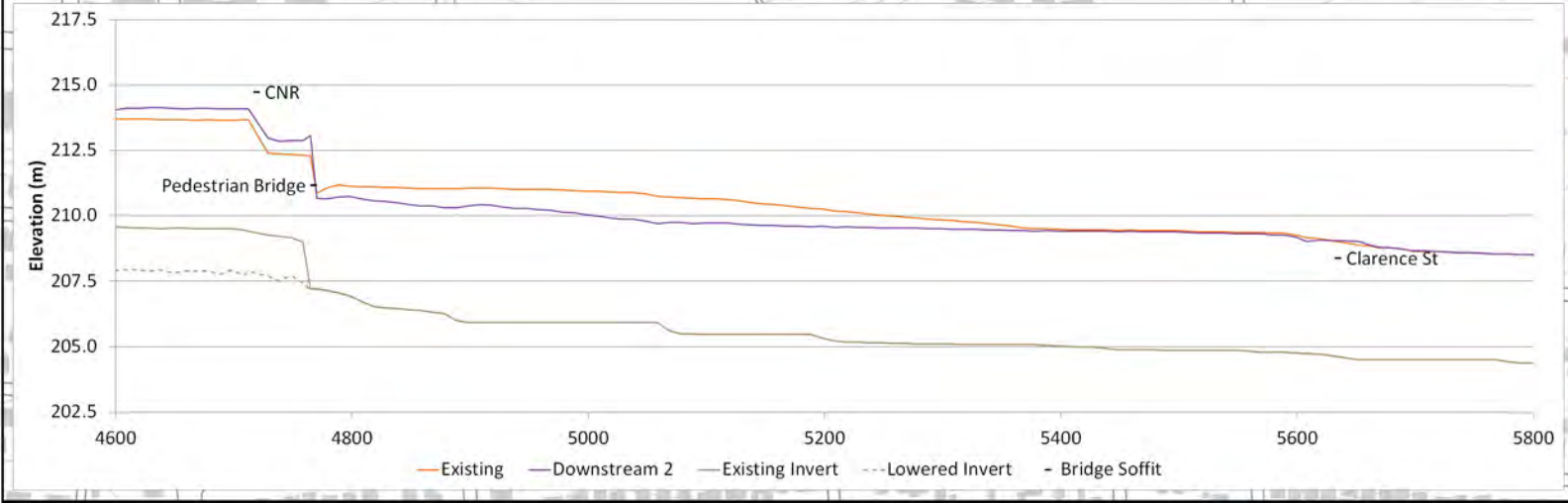
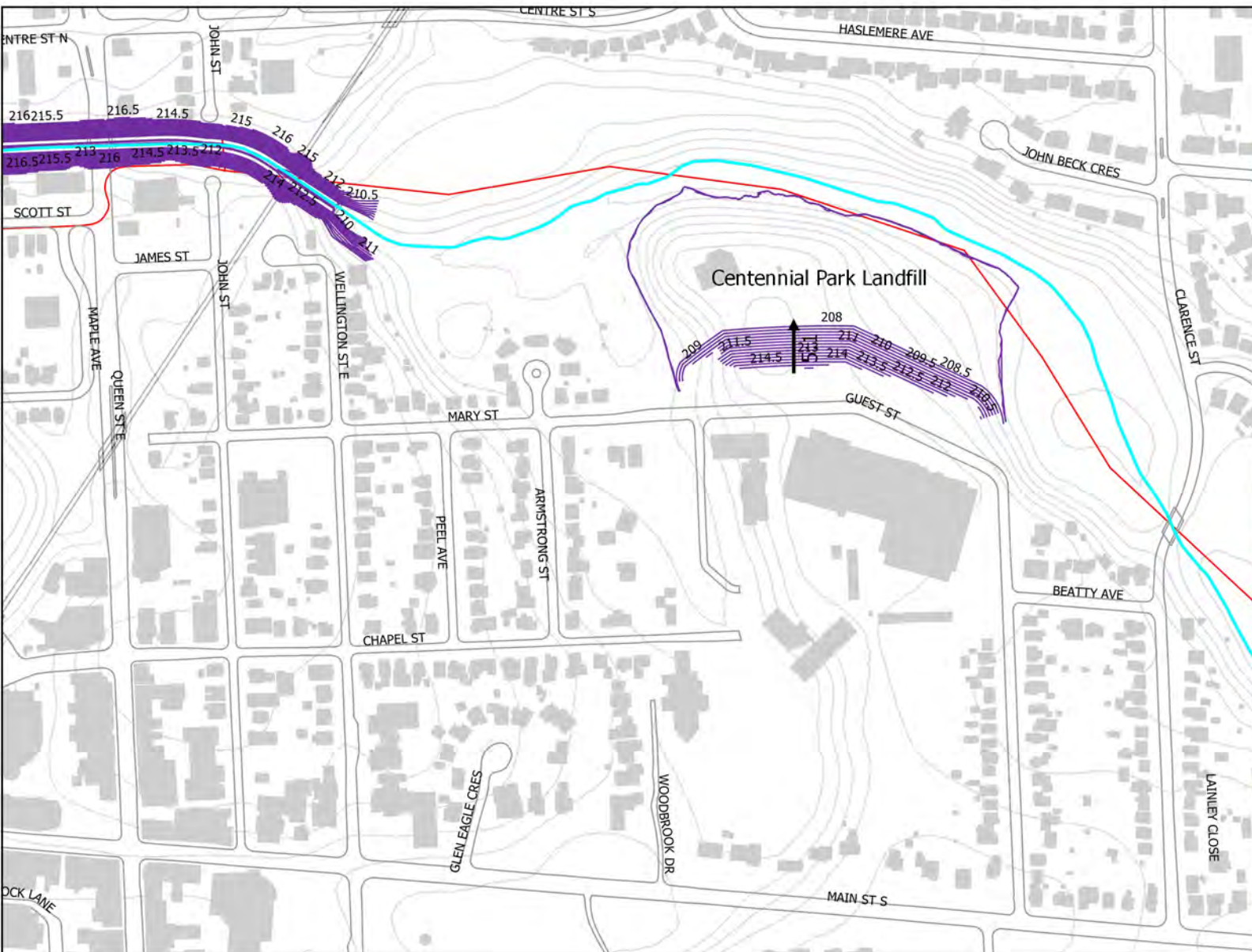

Run Date: December 14, 2017
 Figure Date: December 22, 2017

Note: Proposed alternatives will have impacts on various utilities, most notably the trunk sanitary sewer along the creek. Utility relocation details are to be determined at a later stage.

- | | | |
|----------------------|------------------------|---------------------------|
| Buildings | Max. Depth (m) <= 0.10 | 0.80 - 1.50 |
| Watercourse | 0.10 - 0.30 | 1.50 - 2.00 |
| Existing Contours | 0.30 - 0.50 | > 2.00 |
| Proposed Contours | 0.50 - 0.80 | Riverine Flood Extent |
| Trunk Sanitary Sewer | | Existing Floodline (2017) |

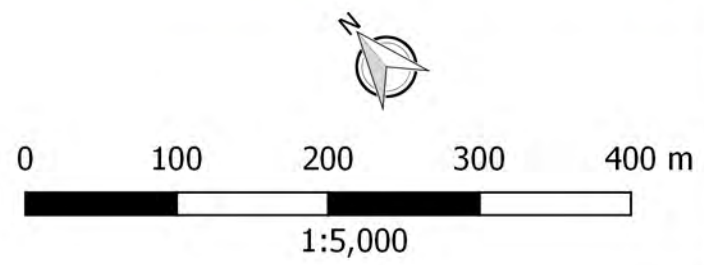

Matrix Solutions Inc.
 ENVIRONMENT & ENGINEERING

Brampton Integrated Flood Study
 Final Report
 Project #22062

Downstream Option 2 Centennial Landfill Regrading/Removal
 Urban: 100-year, Riverine: Regional

Disclaimer: The information contained herein may be compiled from numerous third party materials that are subject to periodic change without prior notification. While every effort has been made by Matrix Solutions Inc. to ensure the accuracy of the information presented at the time of publication, Matrix Solutions Inc. assumes no liability for any errors, omissions, or inaccuracies in the third party material.

K. Molnar
 K. Hofbauer

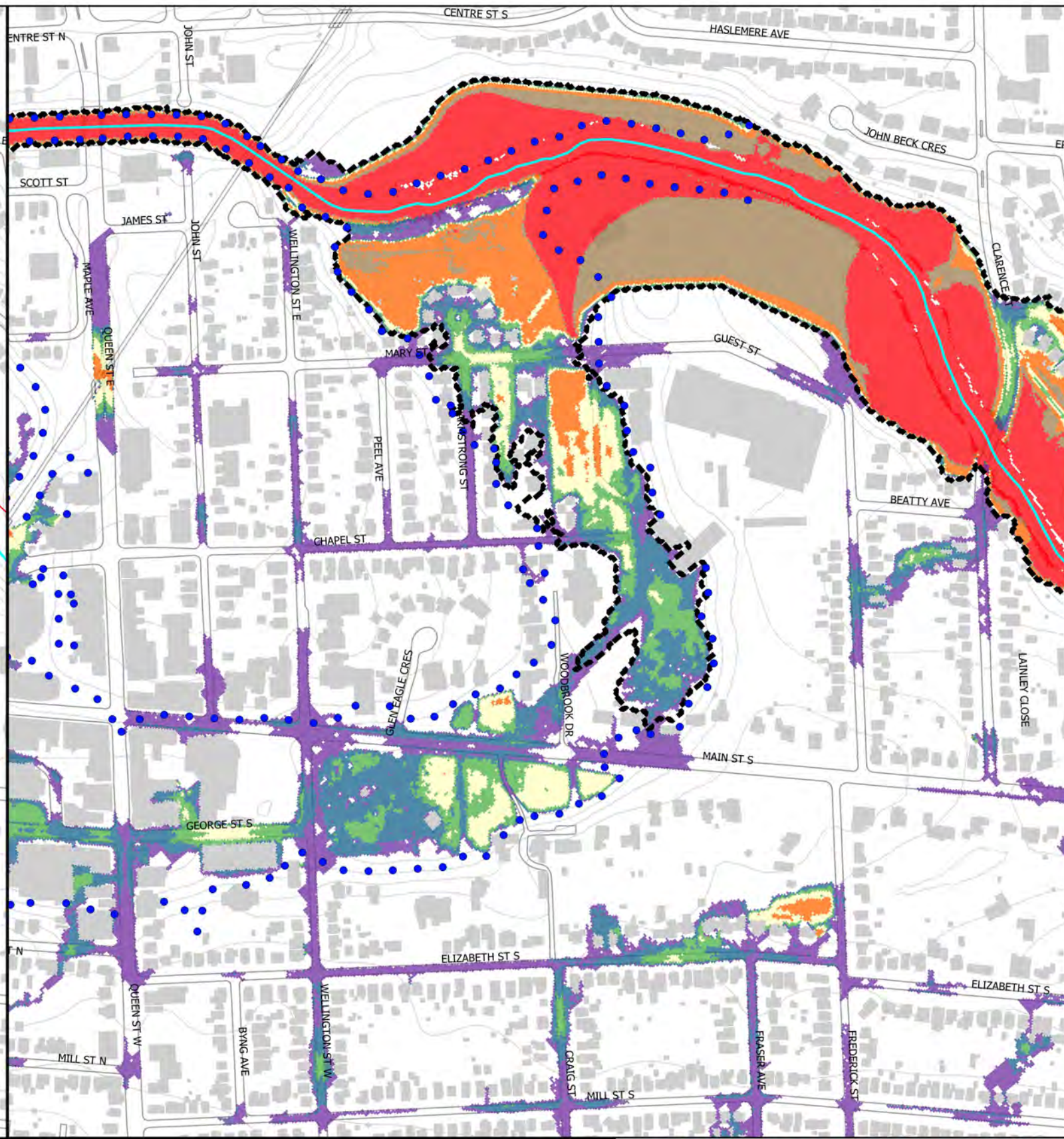
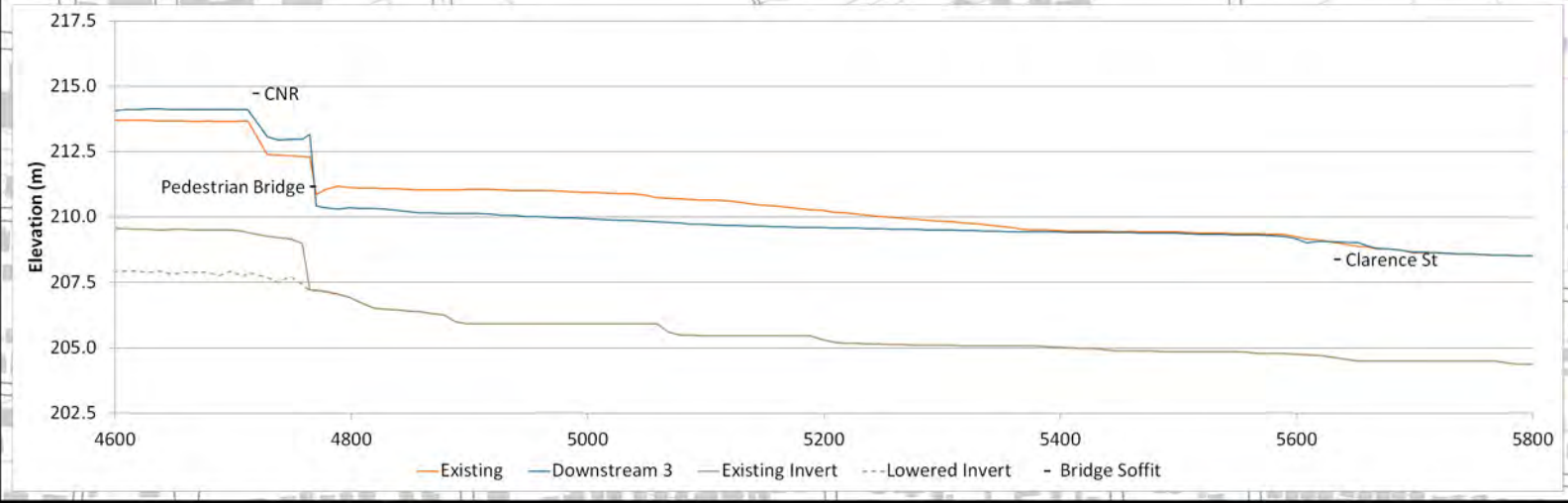
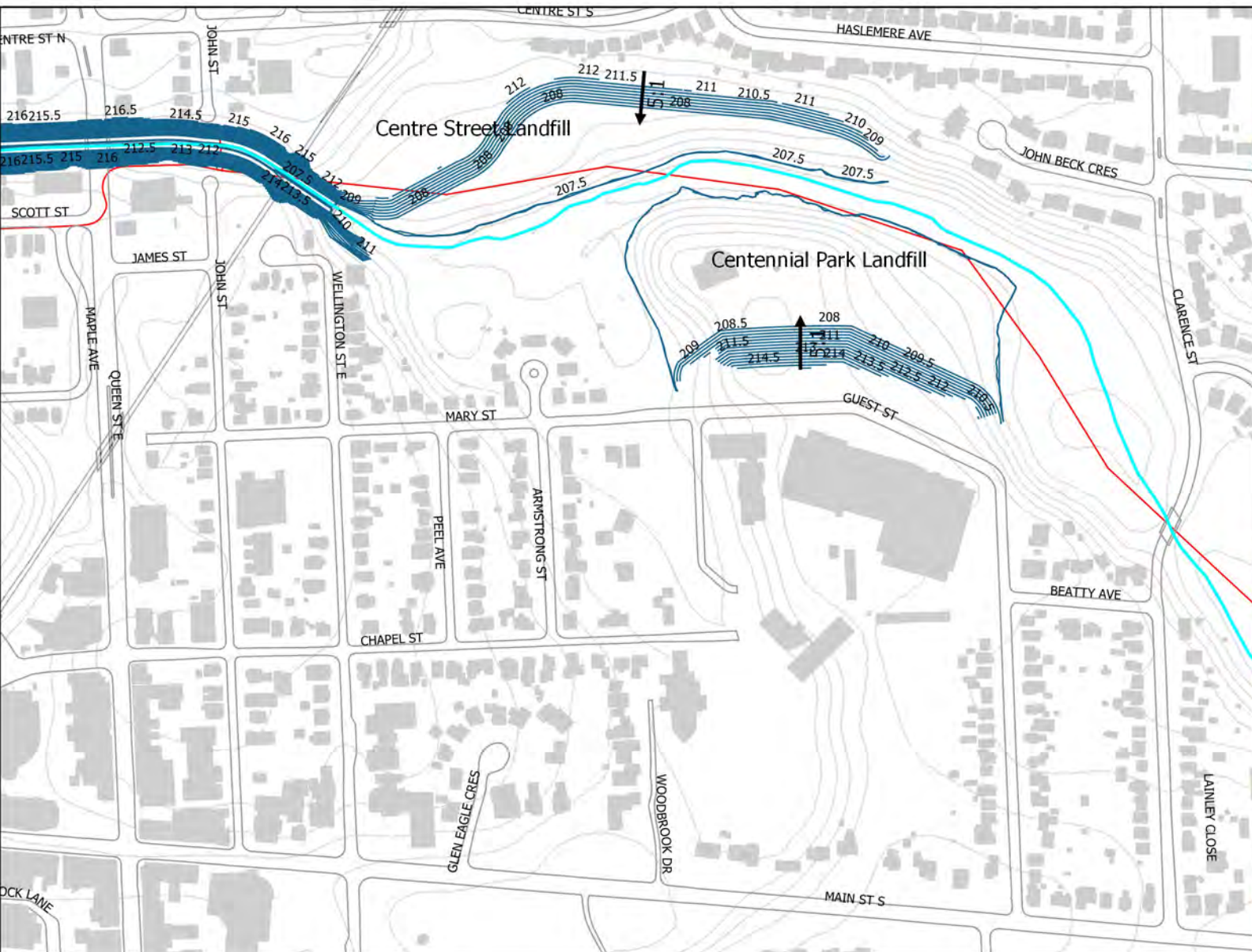

Run Date: December 8, 2017
 Figure Date: December 22, 2017

Note: Proposed alternatives will have impacts on various utilities, most notably the trunk sanitary sewer along the creek. Utility relocation details are to be determined at a later stage.

- Buildings
- Watercourse
- Existing Contours
- Proposed Contours
- Trunk Sanitary Sewer
- Max. Depth (m) <= 0.10
- 0.10 - 0.30
- 0.30 - 0.50
- 0.50 - 0.80
- 0.80 - 1.50
- 1.50 - 2.00
- > 2.00
- Riverine Flood Extent
- Existing Floodline (2017)

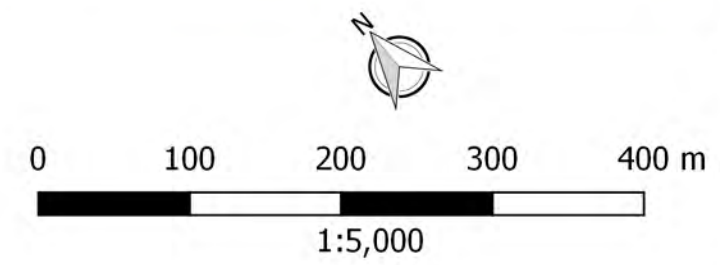

Matrix Solutions Inc.
 ENVIRONMENT & ENGINEERING

Brampton Integrated Flood Study
 Final Report

Downstream Option 3 Both Landfill Regrading/Removal
 Urban: 100-year, Riverine: Regional

Disclaimer: The information contained herein may be compiled from numerous third party materials that are subject to periodic change without prior notification. While every effort has been made by Matrix Solutions Inc. to ensure the accuracy of the information presented at the time of publication, Matrix Solutions Inc. assumes no liability for any errors, omissions, or inaccuracies in the third party material.

K. Molnar
 K. Hofbauer
Figure 38

8.3 Riverwalk Widened Channel Options

Part 2 of the current *Phase 2* study (SGL and FORREC material submitted under separate cover) is focused on the urban design component of the Downtown Brampton flood risk analysis, particularly the proposed Riverwalk, a multi-use recreation trail. The urban design team has indicated a desire for a future trail system adjacent to the creek which will unlock the potential for urban growth and development. The following assessments and alternatives were developed to determine the hydraulic requirements to integrate the urban design with the flood risk protection components.

8.3.1 Bypass Channel Manning's n Assessment

As part of the urban design component of the proposed Riverwalk multi-use trail being undertaken as Part 2 of this study, a number of urban design plans are being considered which have the potential to change the existing surface treatment (concrete) through the bypass channel (i.e., stepped features, plantings, etc.). Changes to the surface treatment will have an impact on the channel roughness and in turn will impact the hydraulic performance of the bypass channel. An assessment of impacts associated with increased Manning's n through the bypass channel was completed.

The roughness assessment was undertaken using the existing HEC-RAS model (Valdor 2017) which allows for a more time-effective method of testing numerous scenarios, as the run times are drastically shorter than those of the MIKE FLOOD model. A memorandum summarizing the bypass channel Manning's n assessment is provided in Appendix G.

In summary, if a surface treatment other than concrete is proposed by the urban design team, the base width of the bypass channel will need to be increased to accommodate the increased roughness and thereby prevent spill. The required increase in channel size will depend on the ultimate roughness, to be determined by TRCA, with likely inclusion of a *Reach Management Strategy* as is explained in Section 8.2.1.

8.3.2 Riverwalk Within Lowered Bypass Channel

The proposed Riverwalk urban design concept includes provision of a multi-use trail along Etobicoke Creek through the study area. To ensure the proposed urban design concept does not adversely impact hydraulics and does not pose a threat to public safety, Matrix completed a HEC-RAS hydraulic assessment to determine the minimum cross-section width required for hydraulic performance and the required elevation of the trail such that it is dry up to and including the 100-year design storm. The aim is to present a trail system at an elevation such that the flood risk for people using it is reasonably acceptable.

For this assessment the cross-sections in HEC-RAS were first modified to reflect lowering the bypass channel by 1.5 m, which was determined to be a viable flood mitigation alternative through preliminary screening discussed above (Section 7.2). The results of this model were reviewed to determine the

100-year flood elevation at each cross-section. The cross-sections were then modified a second time to include a 10 m wide bench for the proposed Riverwalk at the 100-year water elevation.

Based on the results, this mitigation option produces marginal improvements in flood elevations beyond those of the lowered bypass channel (Section 7.2). As such, this alternative is not recommended independently. However, this option could replace the lowered bypass channel option presented in each of the options in Section 8.1.

8.3.3 Riverwalk and Removal of Drop Structures in Bypass Channel

During the original *Phase 1* study (AMEC), the bypass channel lowering was limited to 1.5 m due to conflicts with a trunk sanitary sewer which crosses the river at multiple locations. Of particular concern was the relatively shallow sanitary trunk crossing at the railway bridge. The 1.5 m bypass channel lowering was based on maintaining 1 m of cover above the obvert of the sanitary trunk. This limitation caused the remnant of a 0.9 m drop at the downstream end of the bypass channel with the lowered options previously presented.

Matrix explored an additional option which includes realigning the sanitary trunk sewer to allow for further lowering of the bypass channel by up to 2.6 m. This eliminates the need for a drop structure downstream of the pedestrian bridge as was present in the previous option. Refer to Figure 39 for a schematic of the sanitary realignment concept. Further review of the implications and feasibility of the realignment are anticipated at future considerations of design that will be part of the Environmental Assessment phase of this project.

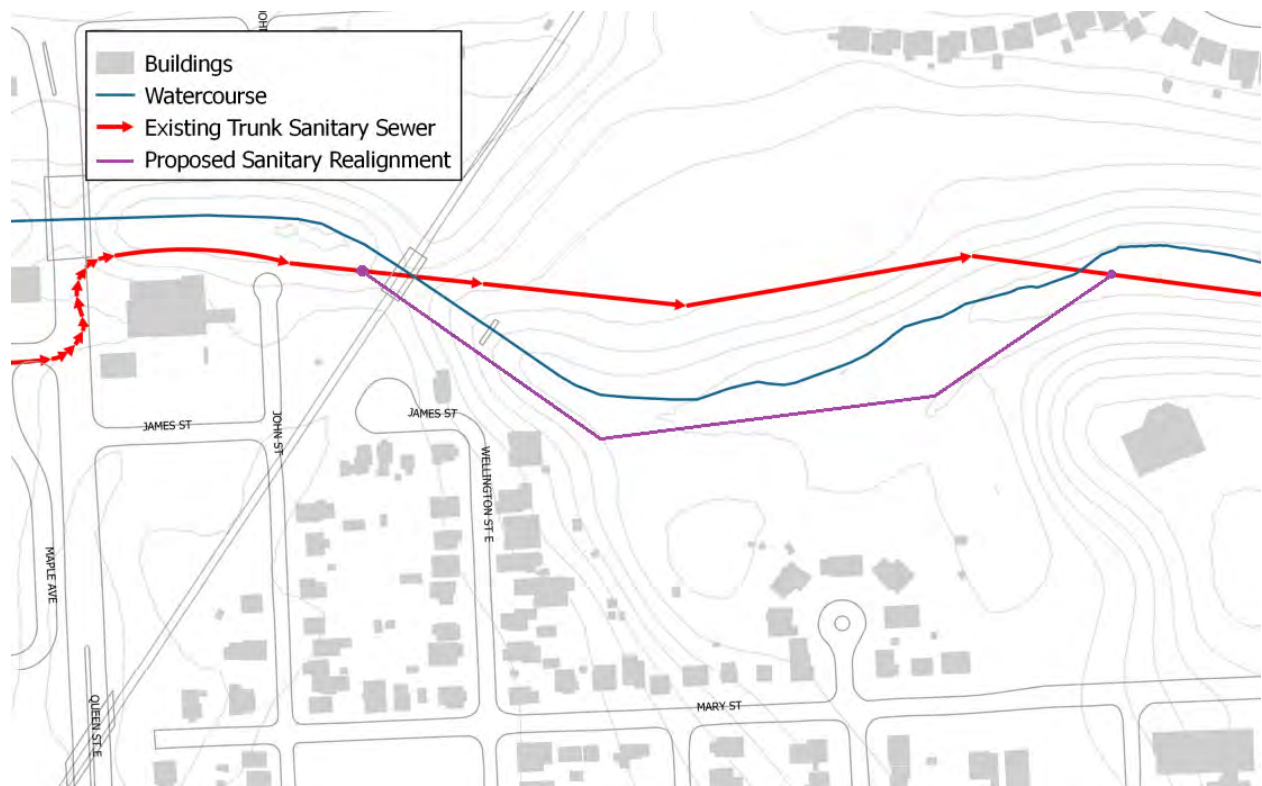

Figure 39 Sanitary Realignment Concept

Using the same method as described in Section 8.3.2, a HEC-RAS hydraulic assessment was undertaken to first lower the bypass channel cross-sections by up to 2.6 m and, based on these results, adjust the cross-sections to incorporate a 10 m wide bench at the 100-year water level for the Riverwalk. The HEC-RAS results for this option revealed a promising reduction in flood elevations and as such this alternative was carried forward for detailed modelling in MIKE FLOOD.

The MIKE FLOOD model was updated to incorporate the proposed Riverwalk and associated widening. Specifically, the MIKE 11 cross-sections between river station 4088.41 and 4878.41 were updated based on the HEC-RAS cross-sections from the preliminary modelling. In addition, the modelling was done with no bridges in the model along the bypass channel (i.e., Church Street, Scott Street, Queen Street, CNR, and pedestrian bridges were removed). To accommodate the 10 m corridor for the proposed Riverwalk, widening of the bridges along the bypass channel is required. Based on results of previous options, the bridges along the bypass channel contribute to backwater effects and the spill upstream of Church Street. To avoid the need to perform multiple model iterations of bridge span to ensure no spill occurs upstream of Church Street, the bridges were removed from the model. We recommend that the bridges be designed to have a clear span wide enough such that they do not have an impact on the Regional flood elevations. As such, the recommended clear span widths are provided in Table 28, which were estimated based on the Regional flood elevations from MIKE FLOOD plus 0.5 m of freeboard.

The modelling of this option includes a combination of the previously identified flood mitigation alternatives that were identified to provide hydraulic benefit. The following components are included in this modelled alternative:

- Ken Whillans Drive realignment and the resultant reconnected floodplain
- bypass channel lowering by up to 2.6 m in combination with sanitary realignment to remove drop structure
- bypass channel widening by up to 15 m to accommodate a 10 m wide Riverwalk trail at the 100-year water level
- increased roughness of bypass low flow channel to 0.035 in the centre and 0.025 on the banks to simulate natural channel features through bypass channel (i.e., non-concrete low flow channel, bricks on the banks, etc.)
- removal of all bridges along the bypass channel from the model to simulate clear span structures spanning the widened channel and Riverwalk
- removal of one or both landfills to maximize floodplain conveyance capacity downstream
- Clarence Street bridge widening from 26.8 to 48.0 m
- MIKE URBAN model deactivated to allow for assessing the hydraulic benefit of the proposed works on riverine flood conditions

Table 28 Recommended Bridge Span

Bridge Location	Existing Soffit Elevation	Recommended Soffit Elevation	Existing Span	Recommended Minimum Span for Hydraulics
Church Street	214.52 m	212.92 m	21.5 m	42 m
Scott Street	216.27 m	212.35 m	21.9 m	38 m
Queen Street	215.28 m	211.77 m	21.7 m	36 m
CNR	214.73 m	211.04 m	22.3 m	34 m
Pedestrian Bridge	211.17 m	210.90 m	12.6 m	40 m

Notes:

⁽¹⁾ Minimum soffit elevation at Regional water elevation + 0.5 m freeboard.

The results of the MIKE FLOOD modelling are shown on Figure 40.1 to 40.4 including depth, velocity, D×V, and flood risk. The results indicate that this option is effective in eliminating the spill upstream of Church Street. The maximum water elevation upstream of Church Street is 213.03 m, which provides 0.4 m of freeboard from the existing Church Street elevation.

At the downstream end, the water elevations have decreased by an average of 1.5 m, reaching a maximum of 209.8 m. The flood extents are significantly reduced, extending to just east of Main Street; no overtopping of Main Street occurs. Review of the velocity and D×V mapping (Figures 40.2 and 40.3, respectively), it is evident that the flooding in the downstream area is primarily due to backwater (minimal velocity). Additionally, safe pedestrian ingress/egress is feasible from all residential properties along Mary Street as well as the seniors' residence, elementary school, and church on Chapel Street.

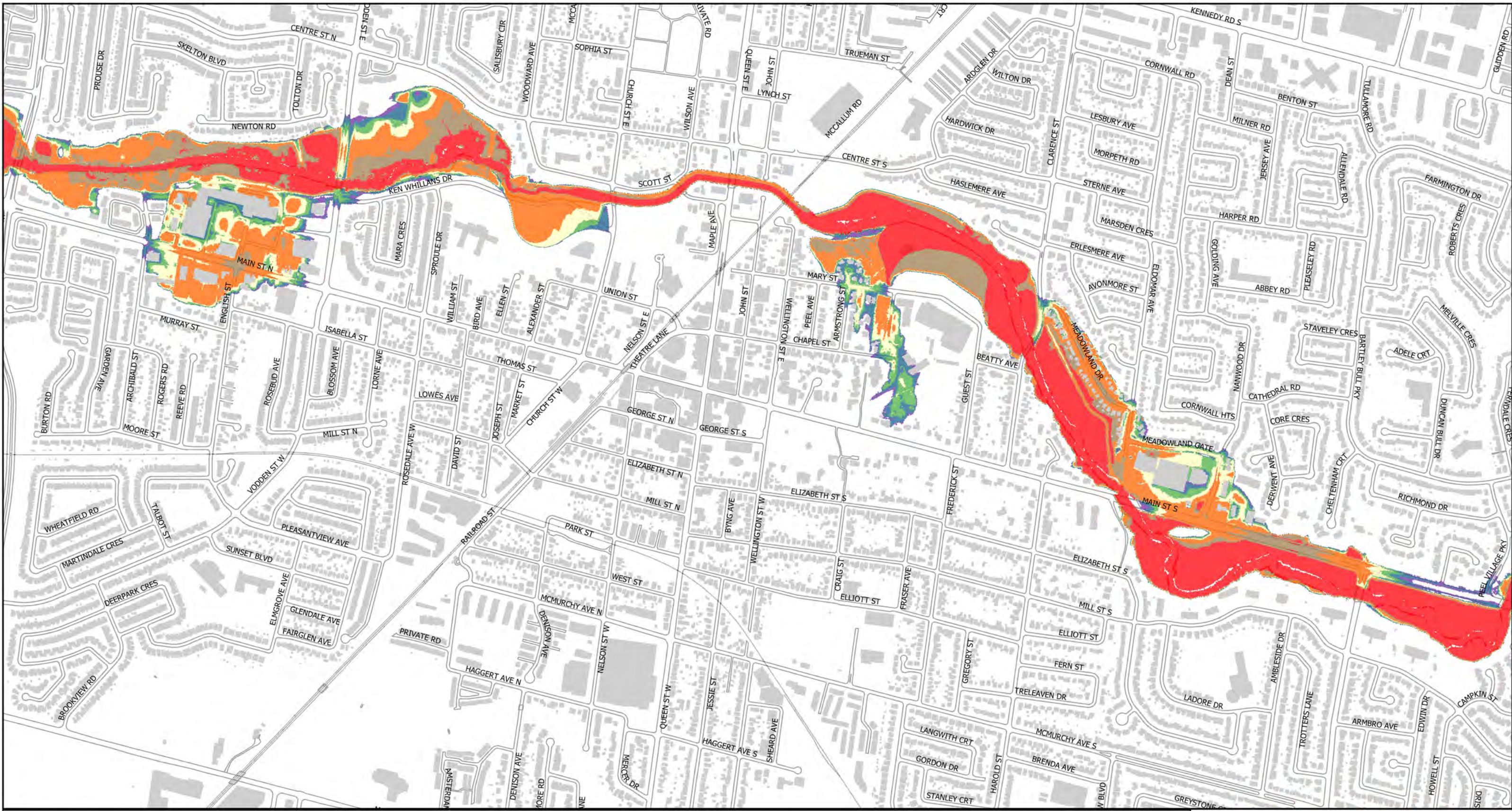

Run Date: March 22, 2018
 Figure Date: March 23, 2018

Maximum Depth (m)	
≤ 0.10	0.50 - 0.80
0.10 - 0.30	0.80 - 1.50
0.30 - 0.50	1.50 - 2.00
	> 2.00



0 250 500 750 1000 m

1:10,000



Brampton Integrated Flood Study
 MIKE FLOOD Results

Project #22062

Regional Storm - Maximum Depth
 Riverwalk + Drop Structure Removal

Disclaimer: The information contained herein may be compiled from numerous third party materials that are subject to periodic change without prior notification. While every effort has been made by Matrix Solutions Inc. to ensure the accuracy of the information presented at the time of publication, Matrix Solutions Inc. assumes no liability for any errors, omissions, or inaccuracies in the third party material.

K. Molnar
 K. Hofbauer

Figure 40.1

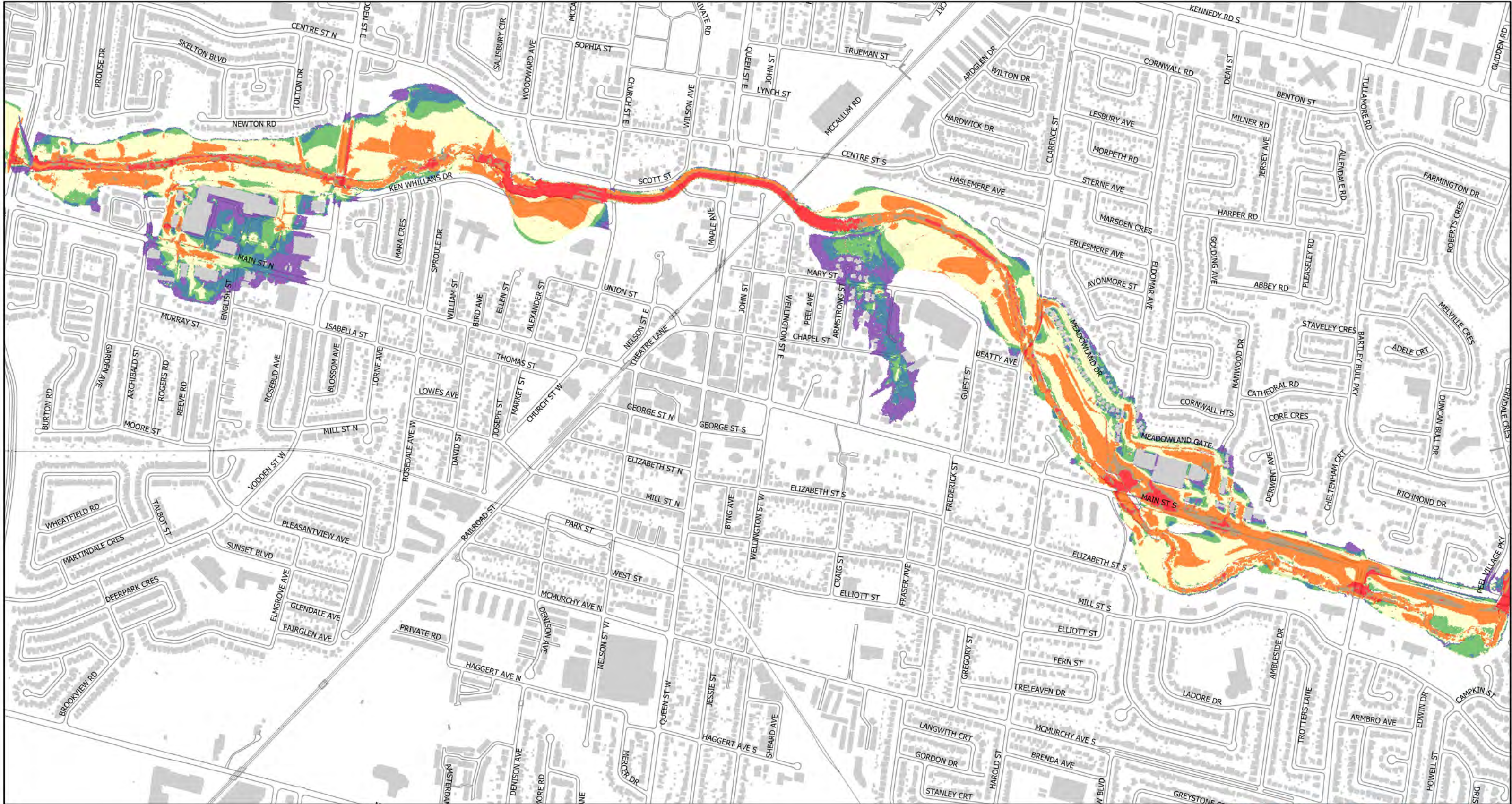

Run Date: March 22, 2018
 Figure Date: March 23, 2018

Max. Velocity (m/s)	
Yellow	0.50 - 1.00
Purple	≤ 0.10
Orange	1.00 - 1.70
Blue	0.10 - 0.25
Brown	1.70 - 2.00
Green	0.25 - 0.50
Red	> 2.00



0 250 500 750 1000 m

1:10,000



Brampton Integrated Flood Study
 MIKE FLOOD Results

Project #22062

Regional Storm - Maximum Velocity
 Riverwalk + Drop Structure Removal

Disclaimer: The information contained herein may be compiled from numerous third party materials that are subject to periodic change without prior notification. While every effort has been made by Matrix Solutions Inc. to ensure the accuracy of the information presented at the time of publication, Matrix Solutions Inc. assumes no liability for any errors, omissions, or inaccuracies in the third party material.

K Molnar
 K Hofbauer
 Figure 40.2

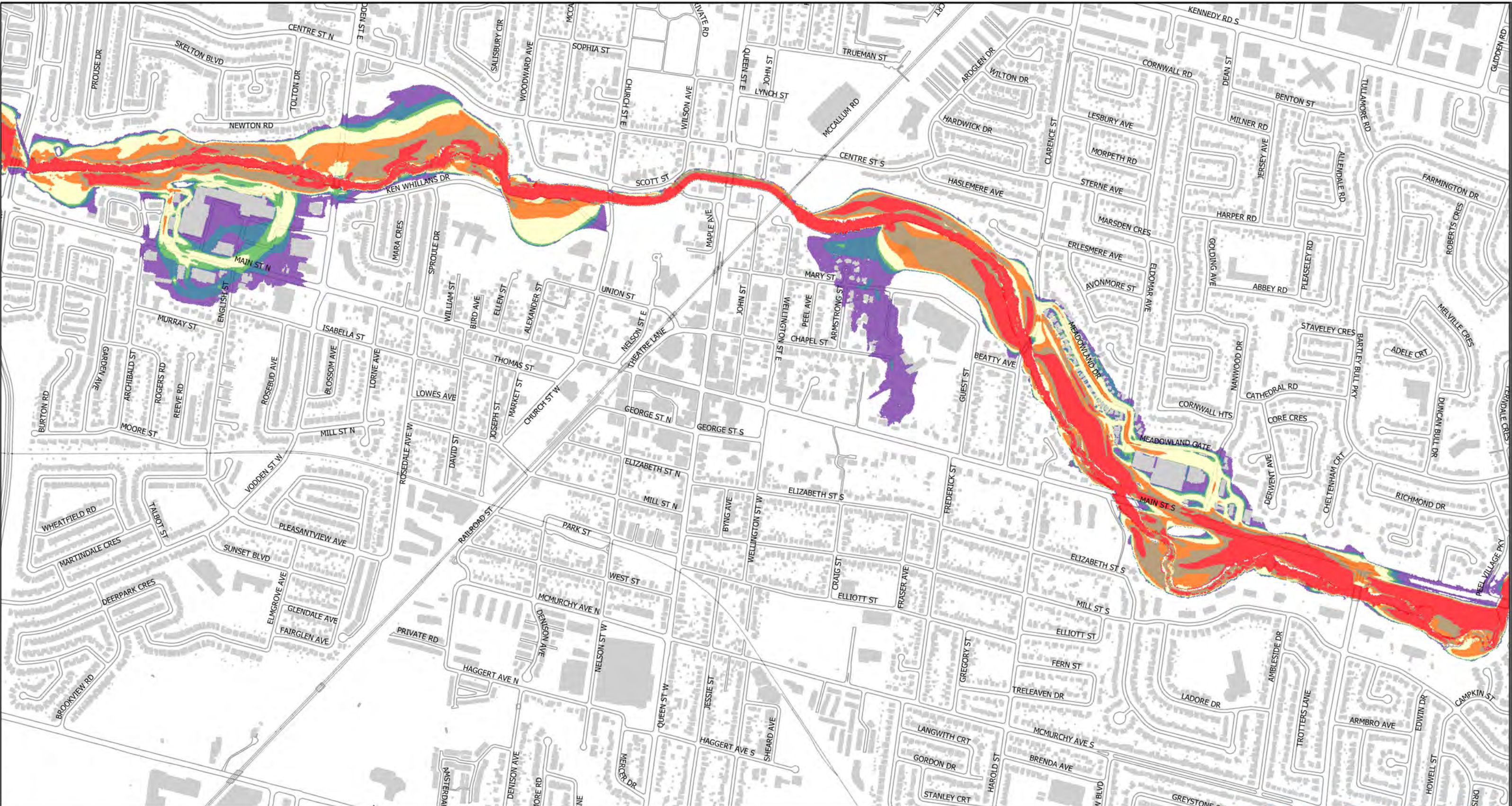

Run Date: March 22, 2018
 Figure Date: March 23, 2018

Max. DxV (m ² /s)	
0.37 - 1.00	1.00 - 1.50
<= 0.10	1.50 - 2.00
0.10 - 0.25	> 2.00
0.25 - 0.370	

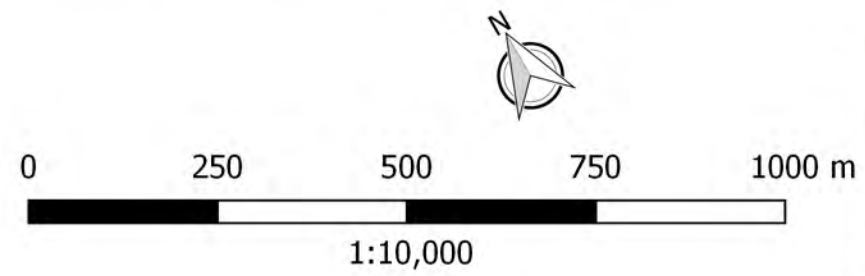

Matrix Solutions Inc.
 ENVIRONMENT & ENGINEERING

Brampton Integrated Flood Study
 MIKE FLOOD Results

Project #22062

**Regional Storm - Maximum Depth x Velocity
 Riverwalk + Drop Structure Removal**

Disclaimer: The information contained herein may be compiled from numerous third party materials that are subject to periodic change without prior notification. While every effort has been made by Matrix Solutions Inc. to ensure the accuracy of the information presented at the time of publication, Matrix Solutions Inc. assumes no liability for any errors, omissions, or inaccuracies in the third party material.

K Molnar
 K Hofbauer
Figure 40.3

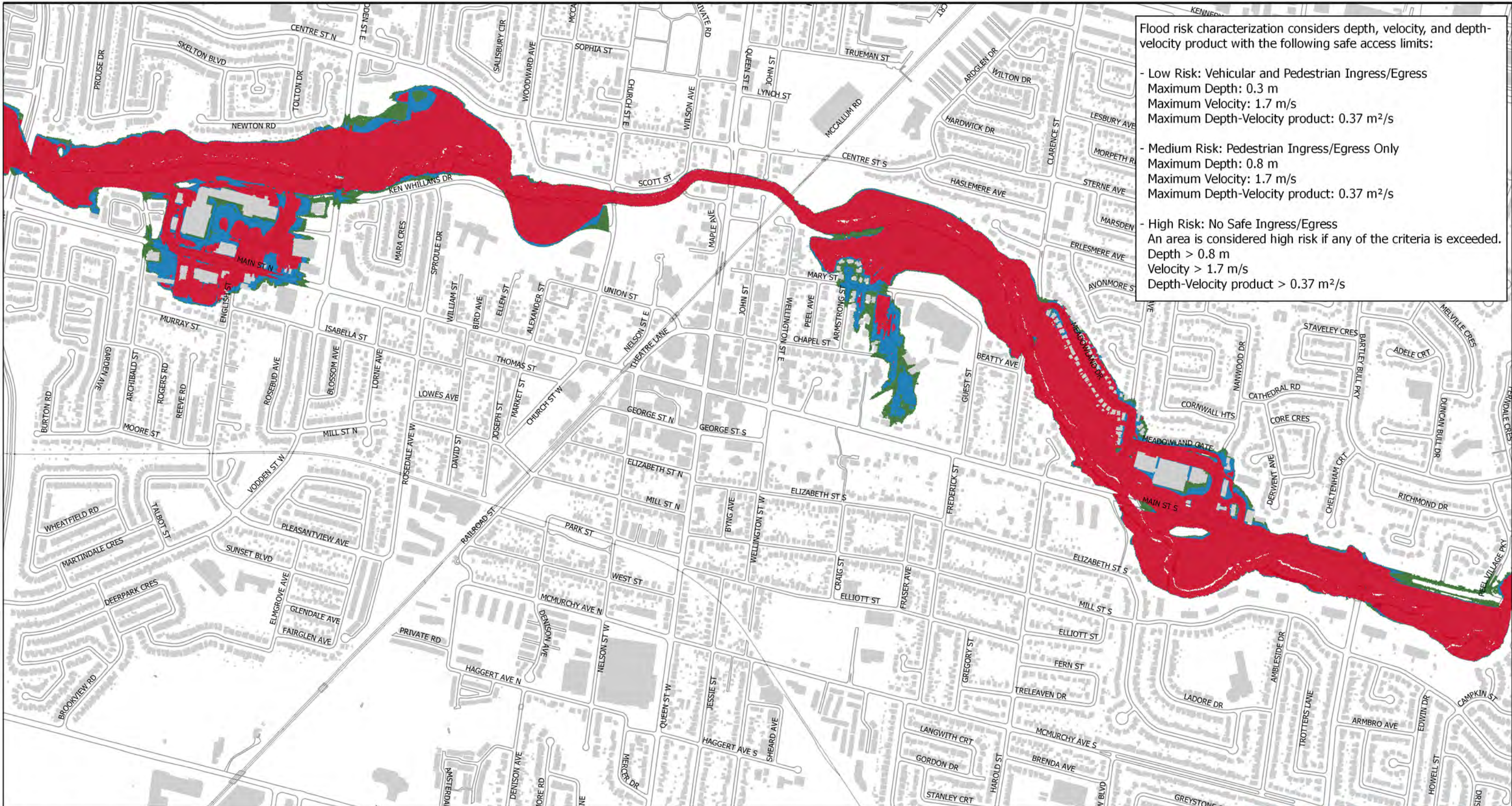

Flood risk characterization considers depth, velocity, and depth-velocity product with the following safe access limits:

- Low Risk: Vehicular and Pedestrian Ingress/Egress
 Maximum Depth: 0.3 m
 Maximum Velocity: 1.7 m/s
 Maximum Depth-Velocity product: 0.37 m²/s
- Medium Risk: Pedestrian Ingress/Egress Only
 Maximum Depth: 0.8 m
 Maximum Velocity: 1.7 m/s
 Maximum Depth-Velocity product: 0.37 m²/s
- High Risk: No Safe Ingress/Egress
 An area is considered high risk if any of the criteria is exceeded.
 Depth > 0.8 m
 Velocity > 1.7 m/s
 Depth-Velocity product > 0.37 m²/s

Run Date: March 22, 2018
 Figure Date: March 23, 2018

Flood Risk
 ■ Low
 ■ Medium
 ■ High

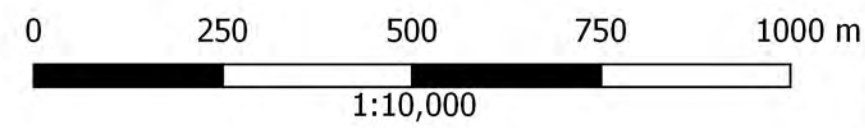

Matrix Solutions Inc.
 ENVIRONMENT & ENGINEERING

Brampton Integrated Flood Study
 MIKE FLOOD Results

Project #22062

Regional Storm - Flood Risk
Riverwalk + Drop Structure Removal

Disclaimer: The information contained herein may be compiled from numerous third party materials that are subject to periodic change without prior notification. While every effort has been made by Matrix Solutions Inc. to ensure the accuracy of the information presented at the time of publication, Matrix Solutions Inc. assumes no liability for any errors, omissions, or inaccuracies in the third party material.

K. Molnar
 K. Hofbauer
Figure 40.4

8.3.4 Riverwalk Option without Floodplain Enhancement

Throughout the course of this study the team has learned that there are historical landfills adjacent to the channel in the reach downstream of the existing bypass channel (refer to WSP 2018). This finding significantly increases the potential costs of floodplain enhancement in this area.

Following the positive results of the above option but recognizing the elevated costs associated with floodplain enhancement in the downstream reach, Matrix explored an additional option, similar to the Riverwalk and removal of drop structures option, but without floodplain enhancement in the downstream reach. The details of the modelling are the same as those presented in Section 8.3.3 except the grading in the downstream reach was reverted to existing conditions. No floodplain improvements downstream of the pedestrian bridge are included in this option.

The results of the MIKE FLOOD modelling are shown on Figure 41.1 to 41.4 including depth, velocity, $D \times V$, and flood risk. In the upstream portion of the study area the results of this option are similar to those presented in Section 8.3.3, indicating that this option is effective at eliminating the spill upstream of Church Street.

In the downstream portion of SPA 3 the extents of flooding have increased compared to that of the previous option. However, compared to existing conditions, the flood extents are significantly reduced. Without the floodplain enhancement the flood extent crosses Main Street and fills Gage Park. In addition, key land uses (i.e., schools, seniors' residences, etc.) fall within areas of high flood risk, primarily due to flood depths. In particular, modelled flood depths adjacent to St. Mary Elementary School are up to 1.2 m, and depths adjacent to St. Mary's Place retirement home are up to 1.5 m. The flood depths over Mary Street are up to 1.7 m, meaning residents on Moore Crescent would not have safe access during the Regional Storm event.

These results indicate that the floodplain enhancement in the downstream reach contributes to notable flood reduction in the downstream end of SPA 3. However, the inundated area may not warrant an SPA designation as the spill near Church Street would be eliminated. It is recommended that this option be carried forward to the EA.

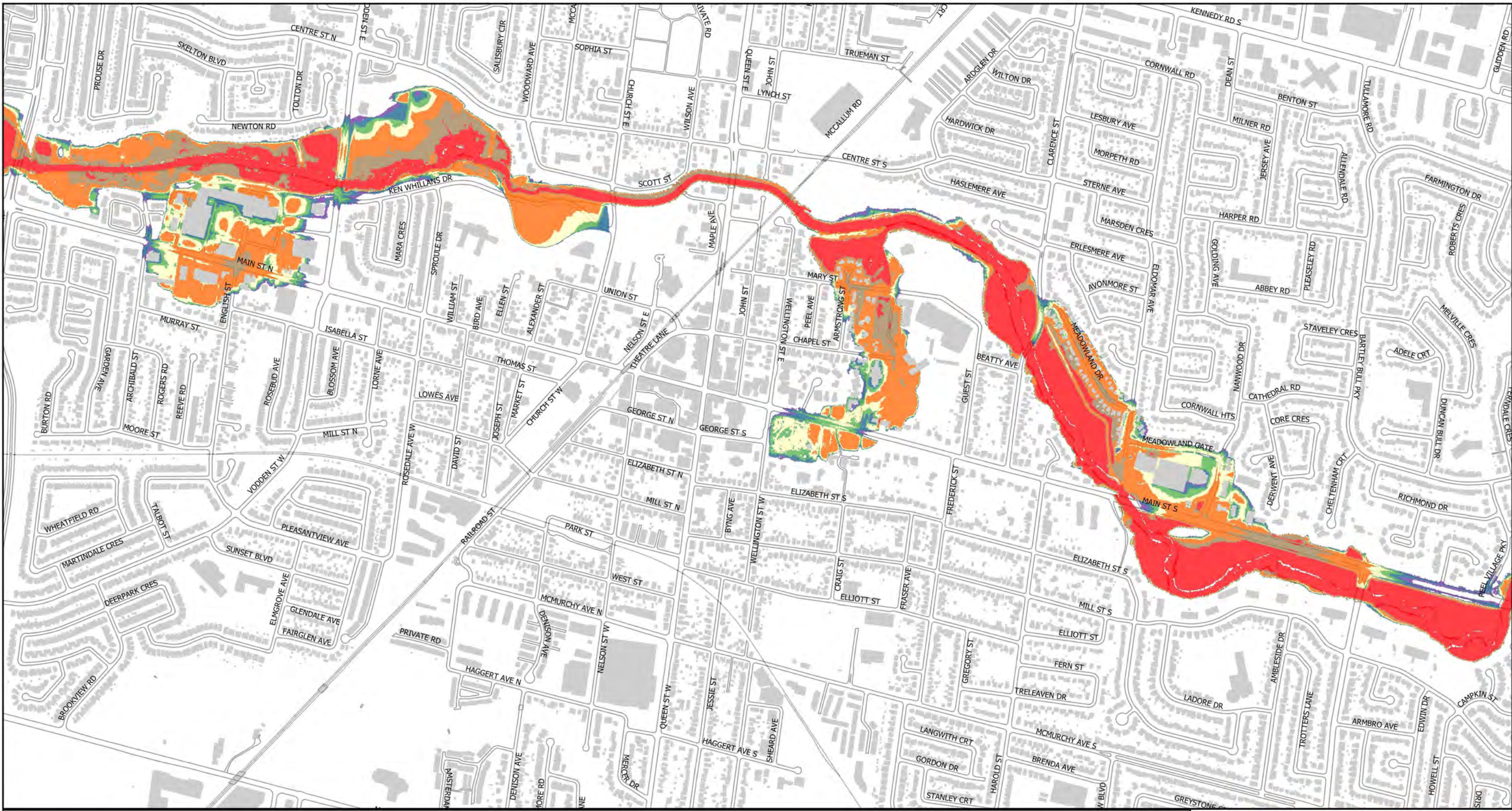

Run Date: May 9, 2018
 Figure Date: May 11, 2018

3-Way Model Results

Maximum Depth (m)	Color
<= 0.10	Light Yellow
0.10 - 0.30	Orange
0.30 - 0.50	Dark Orange
0.50 - 0.80	Red
0.80 - 1.50	Dark Red
1.50 - 2.00	Black
> 2.00	Dark Purple



0 200 400 600 800 m



1:10,000



Brampton Integrated Flood Study
 MIKE FLOOD Results

Project #22062

Regional Storm - Maximum Depth
 Riverwalk without Landfill Removal

Disclaimer: The information contained herein may be compiled from numerous third party materials that are subject to periodic change without prior notification. While every effort has been made by Matrix Solutions Inc. to ensure the accuracy of the information presented at the time of publication, Matrix Solutions Inc. assumes no liability for any errors, omissions, or inaccuracies in the third party material.

K. Molnar
 K. Hofbauer

Figure 41.1

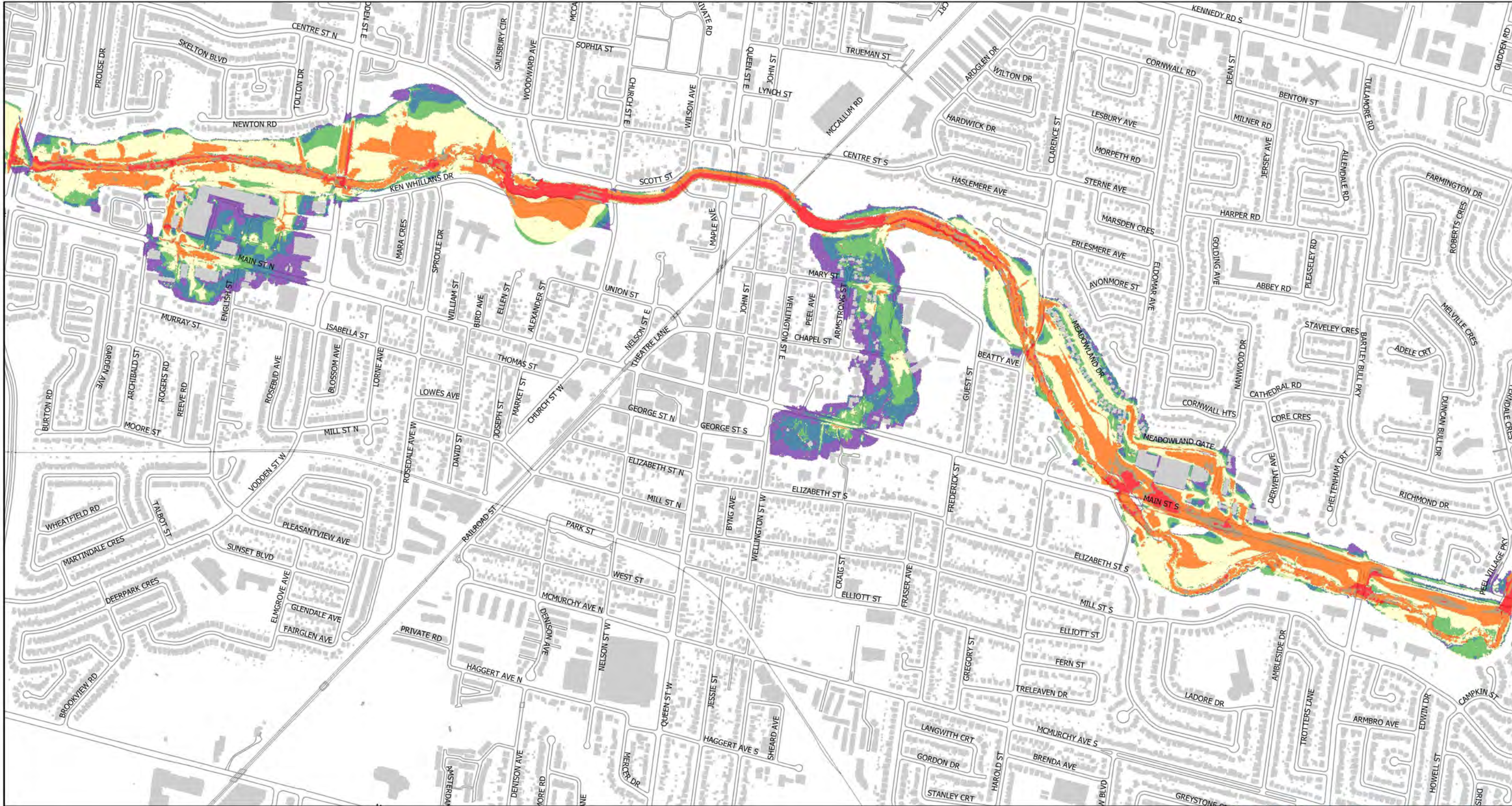

Run Date: May 9, 2018
 Figure Date: May 11, 2018

3-Way Model Results

Max. Velocity (m/s)	Color
<= 0.10	Purple
0.10 - 0.25	Blue
0.25 - 0.50	Green
0.50 - 1.00	Yellow
1.00 - 1.70	Orange
1.70 - 2.00	Brown
> 2.00	Red

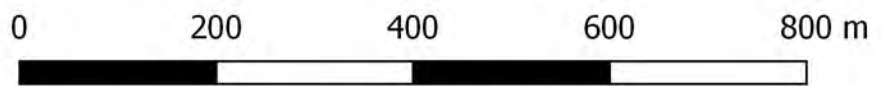

1:10,000



Brampton Integrated Flood Study
 MIKE FLOOD Results

Project #22062

Regional Storm - Maximum Velocity Riverwalk without Landfill Removal

Disclaimer: The information contained herein may be compiled from numerous third party materials that are subject to periodic change without prior notification. While every effort has been made by Matrix Solutions Inc. to ensure the accuracy of the information presented at the time of publication, Matrix Solutions Inc. assumes no liability for any errors, omissions, or inaccuracies in the third party material.

K. Molnar
 K. Hofbauer
 Figure 41.2

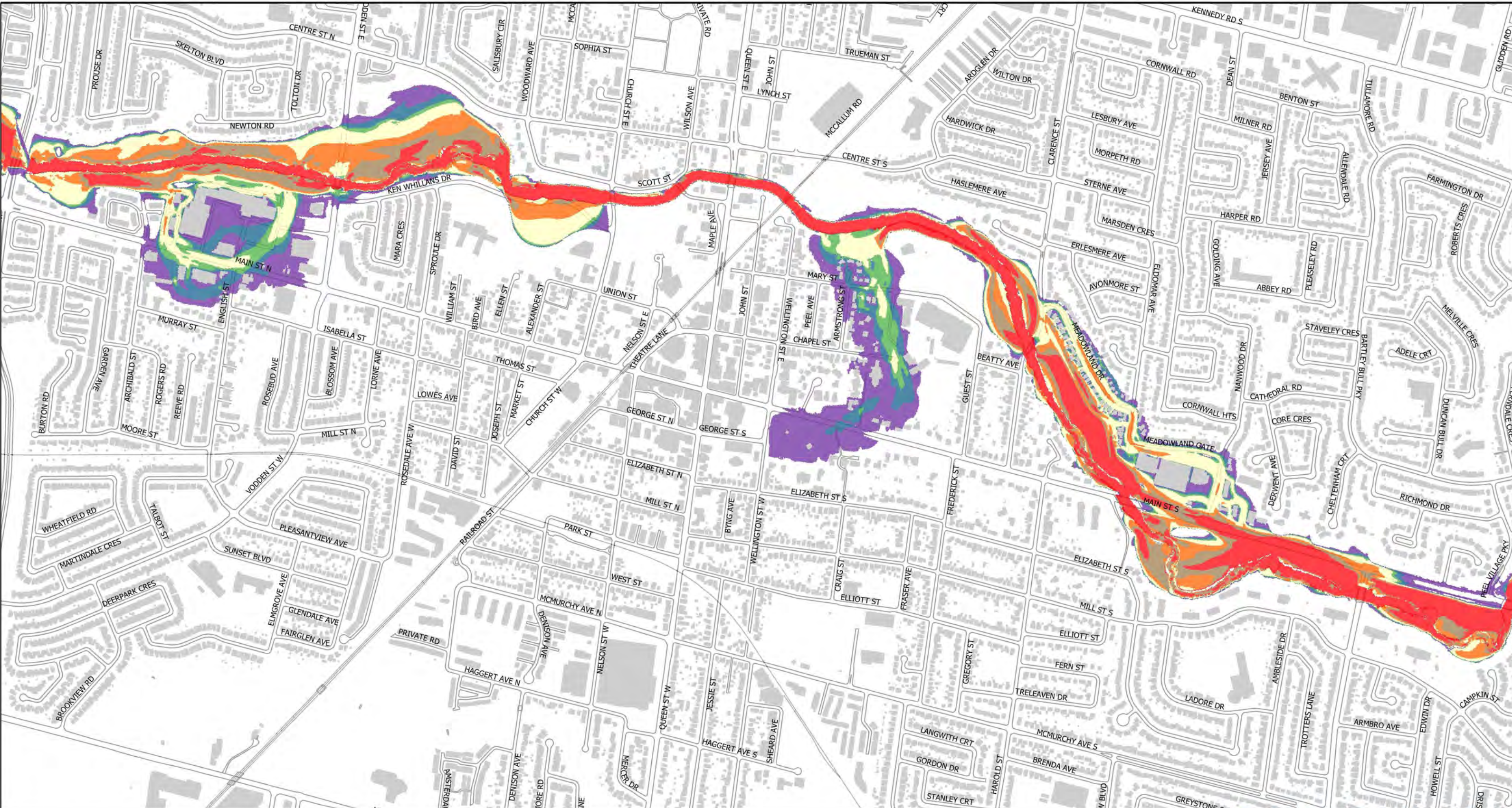

Run Date: May 9, 2018
 Figure Date: May 11, 2018

3-Way Model Results

Max. DxV (m ² /s)	0.37 - 1.00
≤ 0.10	1.00 - 1.50
0.10 - 0.25	1.50 - 2.00
0.25 - 0.370	> 2.00

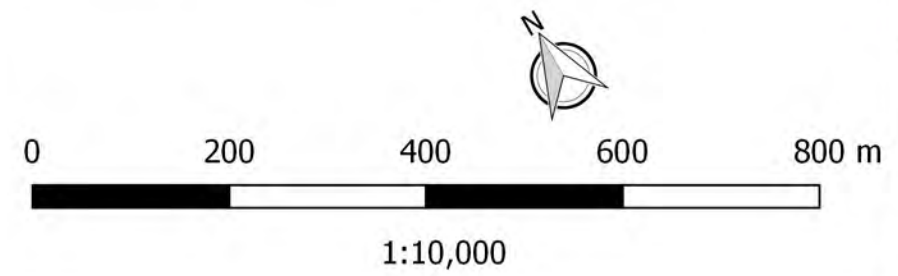

Matrix Solutions Inc.
 ENVIRONMENT & ENGINEERING

Brampton Integrated Flood Study
 MIKE FLOOD Results

Project #22062

**Regional Storm - Maximum Depth x Velocity
 Riverwalk without Landfill Removal**

Disclaimer: The information contained herein may be compiled from numerous third party materials that are subject to periodic change without prior notification. While every effort has been made by Matrix Solutions Inc. to ensure the accuracy of the information presented at the time of publication, Matrix Solutions Inc. assumes no liability for any errors, omissions, or inaccuracies in the third party material.

K. Molnar
 K. Hofbauer
Figure 41.3

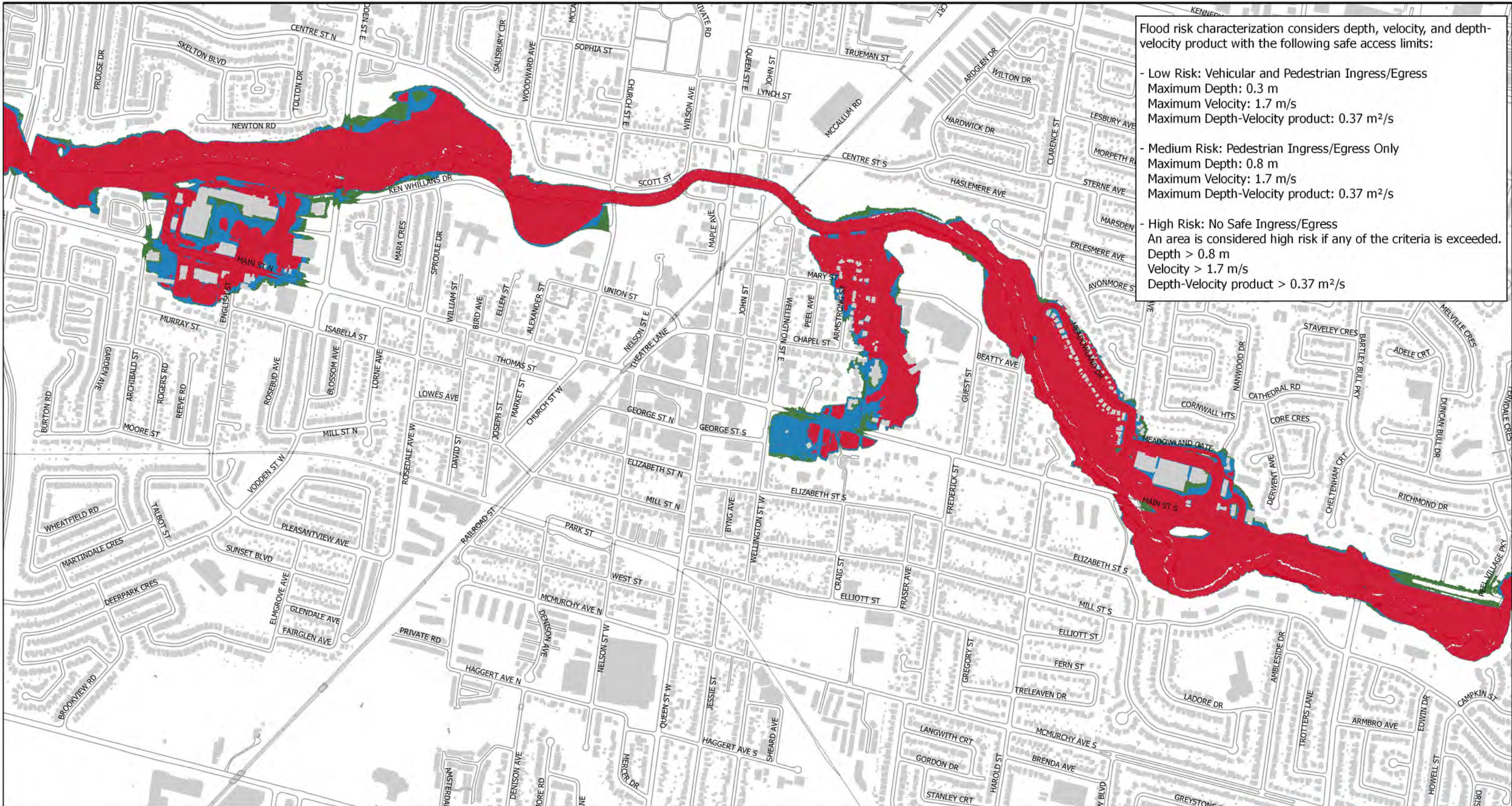

Flood risk characterization considers depth, velocity, and depth-velocity product with the following safe access limits:

- Low Risk: Vehicular and Pedestrian Ingress/Egress
Maximum Depth: 0.3 m
Maximum Velocity: 1.7 m/s
Maximum Depth-Velocity product: 0.37 m²/s
- Medium Risk: Pedestrian Ingress/Egress Only
Maximum Depth: 0.8 m
Maximum Velocity: 1.7 m/s
Maximum Depth-Velocity product: 0.37 m²/s
- High Risk: No Safe Ingress/Egress
An area is considered high risk if any of the criteria is exceeded.
Depth > 0.8 m
Velocity > 1.7 m/s
Depth-Velocity product > 0.37 m²/s

Run Date: May 9, 2018
Figure Date: May 11, 2018

3-Way Model Results

- Risk
- Low (Vehicular and Pedestrian Access/Egress)
 - Medium (Pedestrian Access/Egress Only)
 - High (No Safe Access/Egress)

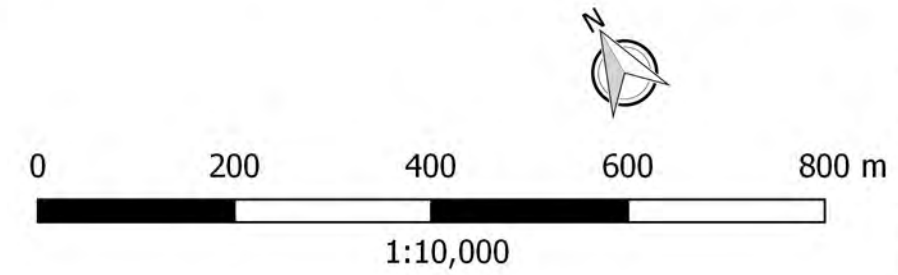

Brampton Integrated Flood Study
MIKE FLOOD Results
Project #22062

Regional Storm - Flood Risk Riverwalk without Landfill Removal

Disclaimer: The information contained herein may be compiled from numerous third party materials that are subject to periodic change without prior notification. While every effort has been made by Matrix Solutions Inc. to ensure the accuracy of the information presented at the time of publication, Matrix Solutions Inc. assumes no liability for any errors, omissions, or inaccuracies in the third party material.

K. Molnar
K. Hofbauer
Figure 41.4

8.4 Discussion of Refined Alternatives

8.4.1 Upstream Options

The three upstream options presented in Section 8.1 are aimed at reducing/eliminating the spill upstream of Church Street. All three options include lowering the bypass channel by 1.5 m in combination with various surface grading works to prevent spill.

Based on the results of the modelling, all three options require a FPL to effectively eliminate the riverine spill. The Ellen Street FPL (Option A) would require a core crest elevation of 215.3 m to provide 0.5 m of freeboard from the Regional Storm flood elevation. Similarly, realigning Ken Whillans Drive to the west to reconnect the floodplain upstream of Church Street (Option B) would require an FPL adjacent to Church Street with a core crest elevation of 215.1 m. The bypass channel entrance feature FPL would require a core crest elevation of 215.2 m. Grading of the FPLs require a large land area; however, the options as discussed in Section 8.1 are effective at eliminating the spill and therefore should be carried forward to the EA stage for further review. We recommend that consultation with MNRF be included at the EA stage to ensure the recommended approach is acceptable.

8.4.2 Downstream Options

The three downstream options presented in Section 8.2 are intended to reduce backwater conditions in the downstream portion of the study area and SPA 3. Each of these three options include widening the Clarence Street bridge to reduce backwater effects. In addition, the downstream options include lowering the bypass channel by up to 1.5 m to provide adequate conveyance capacity and ensure all flow is conveyed through the bypass channel for the Regional Storm event. The downstream options include various combinations of removing existing historical landfills on the east and west sides of Etobicoke Creek downstream of the bypass channel.

Removal of the Centre Street landfill (east side of river) provides minimal benefit to the study area since presence of this landfill does not cause a significant restriction in the flow area of the floodplain and is at or upstream of the low bank area near Moore Crescent. Removal of the Centre Street landfill alone does not provide the desired level of hydraulic benefit and is therefore not recommended for further study.

The Centennial Park landfill (west side of river) creates a significant restriction in the flow area of the floodplain and therefore removal of this landfill provides a notable reduction in flood elevations through the downstream portion of SPA 3. At the time of grading and modelling for the current study the full extent of the Centennial Park landfill was unknown and a 20 m buffer was provided between the slope grading and the private properties on Mary Street/Guest Street. This buffer likely leaves behind a portion of the Centennial Park landfill however additional removals are not anticipated to provide significantly better hydraulic improvements. Future study considerations for additional landfill removals should be based on other considerations (i.e., environmental, safety, etc.) in addition to the hydraulic requirements.

8.4.3 Riverwalk Widened Channel Options

As discussed above, the 1.5 m bypass channel lowering accompanied by a 10 m widening allowance for the Riverwalk does not provide significant benefits to the study area and therefore has been dismissed as a viable alternative on its own. This option would require combination with one of the upstream options discussed above.

Further lowering of the bypass channel (through sanitary sewer realignment) to a total lowering of up to 2.6 m in addition to the 10 m wide Riverwalk was shown to eliminate the spill upstream of Church Street thereby protecting Downtown Brampton from riverine flooding during the Regional Storm event without the need for an FPL. In comparing the results of the Riverwalk option with and without floodplain enhancement, it is evident that increased floodplain connectivity in the downstream reach contributes to a notable reduction in flood levels in the downstream portion of SPA 3. We recommend that the Riverwalk and Removal of Drop Structure option both with and without floodplain enhancements in the downstream reach be carried forward to further study in the EA stage.

At present, the concrete bypass channel combined with the existing drop structure creates a 'self-cleaning' system whereby, under normal flow conditions, the drop structure prevents backwater from occurring upstream allowing continuous flow to flush the bypass channel. Comments from TRCA confirm that there have not been any maintenance issues associated with sedimentation in the bypass channel. During the EA stage maintenance requirements for the low flow channel should be considered related to elimination of the drop structure and/or alteration of the surface treatment through the bypass channel (i.e., stepped features, plantings, etc.).

8.5 Other Considerations for Future Studies

8.5.1 Design of Bridges over Bypass Channel

The bridges within the bypass channel should be reviewed as part of future studies as bridges will require widening to accommodate the proposed Riverwalk within the bypass channel. Furthermore, the majority of the existing bridges over the bypass channel impact the backwater elevations in Regional flow conditions.

Since the design of the future bridge replacements along the bypass channel was not considered for this study, the completed hydraulic modelling of mitigation alternatives removed the bridges along the bypass channel (Church Street, Scott Street, Queen Street, CNR, and pedestrian bridge) assumes that they would be replaced with structures with adequate spans to meet hydraulic requirements as well as to accommodate the proposed Riverwalk. It is recognized that this simplification must be confirmed with future analysis of bridge structures that consider overall feasibility of construction and cost.

8.5.2 Urban Drainage Network Modifications

During the existing condition flood characterization we identified inlet capacity as a flood mechanism for urban flooding. As discussed in Section 5.2.1.2, a number of inlets do not have capacity to capture the modelled runoff from the directly connected catchments. All inlets were modelled as single CBs; however a field inventory completed by City staff indicated that a number of these were actually double CBs and therefore can intercept more runoff. If future studies make use of the 3-way coupled model, we recommend that the MIKE URBAN model be updated to reflect double CBs as appropriate.

9 IMPLEMENTATION PLAN AND COST ESTIMATE

The flood mitigation alternatives presented in the previous section are focused on reducing riverine spill into SPA 3 in an attempt to manage flood risks within Downtown Brampton and to promote development and growth. These flood mitigation alternatives do not address urban flooding issues. Following the flood mitigation alternative assessment an implementation plan was prepared including conceptual design and preliminary cost estimates for each alternative and combinations thereof which are recommended to be carried forward to future studies.

9.1 Recommendations for Environmental Assessment

The flood mitigation alternatives presented above were modelled using the 3-way coupled MIKE FLOOD model. Results prepared to date indicate potential for significant improvements in flood conditions. The goal of this *Phase 2* project is not to put forward preferences on alternatives; therefore, a recommended alternative has not been put forth in this report. Instead, the recommendations in Table 29 are provided for further consideration as part of the Environmental Assessment that is anticipated for this project.

Table 29 Short-Listed Alternatives for Environmental Assessment

Flood Mitigation Alternative	Other Components				Considerations
	FPL	Bypass Channel Lowering	Bypass Bridge Replacement	Clarence Bridge Widening	
Upstream Option A Ellen Street FPL	✓	✓	✓		FPL required Sanitary realignment required
Upstream Option B Reconnected Floodplain	✓	✓	✓		FPL required Large span bridge at Church Street required
Upstream Option C Bypass Channel Entrance Feature	✓	✓	✓		FPL required Large span bridge at Church Street required
Downstream Option 2 Centennial Park Landfill Removal		✓	✓	✓	Assess impacts of full removal of Centennial Park landfill
Downstream Option 3 Removal of Both Landfills		✓	✓	✓	Assess impacts of full removal of Centennial Park landfill
Riverwalk Option including Removal of Drop Structures in Bypass Channel		✓	✓	✓	Sanitary realignment required Bridge replacements required (all bridges on bypass channel)

9.2 Cost Estimates

Capital cost estimates were prepared for the refined flood mitigation alternatives. Refer to Appendix I for itemized cost estimates for each of the alternatives. The cost estimates provided in Table 30 do not include any costs associated with the bypass channel lowering (i.e., earthworks, grading, bridge works, etc.). At this stage there is too much uncertainty around the details of bridge work that would be required to accommodate the bypass channel lowering and associated widening. Additionally, all six of the refined flood mitigation alternatives include bypass channel lowering and therefore including the cost of this item would simply increase all estimates by the same amount. Comprehensive cost estimates including all elements should be prepared during the forthcoming EA.

Table 30 Capital Cost Estimate

Flood Mitigation Alternative	Capital Cost	Items
Upstream Option A Ellen Street FPL	\$3.57M	<ul style="list-style-type: none"> Ellen Street FPL (cut & place fill, import fill) Church Street/Ken Whillans Drive modifications 1,200 mm sanitary sewer relocation
Upstream Option B Reconnected Floodplain	\$3.20M	<ul style="list-style-type: none"> Ken Whillans Drive realignment Church Street modifications including bridge work Church Street FPL (cut & place fill, import fill) 1,200 mm sanitary sewer relocation
Upstream Option C Bypass Channel Entrance Feature	\$4.18M	<ul style="list-style-type: none"> Ken Whillans Drive realignment Church Street modifications including bridge work Rosalea Park FPL (cut & place fill, import fill) 1,200 mm sanitary sewer relocation
Downstream Option 2 Centennial Park Landfill Removal	\$20.95M ⁽¹⁾	<ul style="list-style-type: none"> Landfill removal (cut & dispose fill) 1,200 mm sanitary sewer relocation
Downstream Option 3 Removal of Both Landfills	\$39.26M ⁽¹⁾	<ul style="list-style-type: none"> Landfill removal (cut & dispose fill) 1,200 mm sanitary sewer relocation
Riverwalk and Removal of Drop Structures in Bypass Channel	\$30.22 ⁽¹⁾	<ul style="list-style-type: none"> Ken Whillans Drive modifications Bridge widening (5 bridges) Landfill removal (cut & dispose fill) 1,200 mm sanitary sewer relocation

Notes:

⁽¹⁾ Cost estimates associated with landfill removal were obtained from the waste delineation report (WSP 2018)

9.3 Municipal Class Environmental Assessment Requirements

The Municipal Class Environmental Assessment (Class EA) document (Municipal Engineers Association 2015) outlines a comprehensive planning process which includes the following steps: problem definition; identification of alternatives; analysis and evaluation of their effects on all aspects of the environment including the natural, social, economic environment and engineering; determination of a recommended alternative. The Class EA process provides a rational planning approach to determining a preferred alternative for addressing the problem (or opportunity). It is an approved planning document which describes the process that proponents must follow in order to meet the requirements of the Ontario *Environmental Assessment Act*. Providing the Class EA process is followed, a proponent does not have to apply for formal approval under the *Environmental Assessment Act*.

There are four types of projects to which the Municipal Class EA applies. The types of Class EA projects are described below:

Schedule 'A'

- projects which are limited in scale, have minimal adverse environmental effects, and include the majority of municipal road maintenance and operational activities
- these projects are pre-approved and may proceed to implementation without following the Class EA planning process

Schedule 'A+'

- similar to Schedule A projects these projects are limited in scope and have minimal adverse environmental effects
- these projects are pre-approved; however, the public is to be advised before project implementation

Schedule 'B'

- projects which have the potential for some adverse environmental effects
- these projects are subject to a screening process which includes contacting directly affected public and relevant review agencies

Schedule 'C'

- projects which have the potential for significant environmental effects and which must proceed under the full planning and documentation procedures specified in the Class EA document

Projects which cannot be encompassed within the Class EA process due to scale, complexity, or potential for significant environmental effects require an Individual EA. These projects require MOECC approval.

The City and TRCA shall consider the components and requirements of the short-listed options presented in Table 30 to determine the appropriate EA process for continuing this study.

10 REFERENCES

AMEC Foster Wheeler Environment & Infrastructure (AMEC Foster Wheeler). 2016. *Downtown Brampton Flood Protection Feasibility Study*. Report prepared for Company. Burlington, Ontario. July 2016.

AMEC Environment & Infrastructure (AMEC). 2012. *Toronto and Region Conservation Authority Flood Protection and Remedial Capital Works Program*. Draft report prepared for the Toronto and Region Conservation Authority. Burlington, Ontario. December 2012.

Aquafor Beech Limited (Aquafor). 2008. *Downtown Drainage Study, Part 2: Stormwater Management*. Draft report prepared for the City of Brampton. Brampton, Ontario. April 2008.

Aquafor Beech Limited (Aquafor). 2006. *Downtown Drainage Study, Part 1: Flood Risk Assessment*. Report prepared for the City of Brampton. Brampton, Ontario. June 2006.

City of Brampton (the City). 2008. *Subdivision Design Manual*. Brampton, Ontario. December 2008.

- City of Brampton (the City). 2014a. *Downtown Brampton Special Policy Area, Comprehensive Flood Risk and Management Analysis*. Final Submission. Brampton, Ontario. February 2014.
- City of Brampton (the City). 2014b. *Downtown Etobicoke Creek Revitalization Study*. Brampton, Ontario. July 31, 2014.
- Civica Infrastructure Inc. (Civica). 2013. *Visual OTTHYMO (VO) v3.0, User's Guide*. May 10, 2013.
http://www.visualotthymo.com/downloads/VH_Otthymo_Manual.pdf
- Credit Valley Conservation (2011). *CVC Standard Parameters*. Retrieved from
<http://www.creditvalleyca.ca/planning-permits/planning-services/engineering-plan-review/stormwater-management/cvc-standard-parameters/>
- Danish Hydraulic Institute (DHI). 2017. *2D Urban Flood Model Development*. Cambridge, Ontario. September 1, 2017.
- Danish Hydraulic Institute (DHI). 2016. *MIKE FLOOD, 1D-2D Modelling User Manual*. MIKE Powered by DHI. 2016. Available from
http://manuals.mikepoweredbydhi.help/2017/Water_Resources/MIKE_FLOOD_UserManual.pdf
- Golfieri B., Mason E., Goltara A., and E. Silver. 2017. *Benefits of European River Restoration Schemes: An Analysis of 13 Case Studies Aiming to Integrate Improvement of Ecological Conditions and Flood Risk Mitigation*. December 2017.
http://www.ecrr.org/Portals/27/RR-for-flood-risk-mitigation_FINAL.pdf
- Greck and Associates Limited (Greck). 2010. *Etobicoke Creek Watershed Floodline Mapping HEC-RAS Model*. Prepared for Toronto and Region Conservation Authority. Woodbridge, Ontario. October 2010.
- Metropolitan Area Planning Council (MAPC). 2015. *Neponset Outfall Catchment Analysis*. Boston, Massachusetts. February 2015. 30 pp.
- Ministry of Transportation (MTO). 1997. *Drainage Management Manual*. Drainage and Hydrology Section, Transportation Engineering Branch, Quality and Standards Division.
- MMM Group Limited (MMM). 2013. *Etobicoke Creek Hydrology Update*. Draft report prepared for the Toronto and Region Conservation Authority. April 2013.
- Municipal Engineers Association. 2015. *Municipal Class Environmental Assessment (MCEA)*. October 2000, as amended in 2007, 2011 and 2015.

- Toronto and Region Conservation Authority (TRCA). 2017. *Flood Plain Map – Frequently Asked Questions*. Retrieved from <https://trca.ca/conservation/flood-risk-management/flood-plain-map-viewer/>
- Toronto and Region Conservation Authority (TRCA). 2016. *Approaches to Manage Regulatory Event Flow Increases Resulting from Urban Development*. Toronto, Ontario. June 2016.
- Toronto and Region Conservation Authority (TRCA). n.d. *Standard Manning’s Roughness Coefficients for TRCA Watershed Hydraulic Modelling*.
- Transport Association of Canada (TAC). 2017. *Geometric Design Guide for Canadian Roads*. 2017 Edition. Ottawa, Canada. June 2017.
- Valdor Engineering Inc. (Valdor). 2017. *Downtown Brampton Floodplain Mapping Update*. Report prepared for Toronto and Region Conservation Authority. Woodbridge, Ontario. March 2017.
- WSP Canada Inc. (WSP). 2018. *Waste Delineation and Characterization Report, Centennial Park and Center Park Landfill Areas*. Brampton, Ontario. April 2018.
- WSP Canada Inc. (WSP). 2014. *City of Brampton Central Area Sustainable Infrastructure Study*. Report prepared for the City of Brampton. Markham, Ontario. December 2014.

APPENDIX A
Record of Received Data

APPENDIX A

RECORD OF RECEIVED DATA

TABLE A1 GIS and Topographic Information

	Data Description	Received Date/Method	Notes
✓	1. Land use data (TRCA/City)	June 9, 2016 / City FTP (background data Part 1.zip)	The received data only covered the northwest half of the study area. 
		June 28, 2016 (CDs from Maggie - CD 1)	The data received covers the remaining area.
✓	2. Watercourse locations (TRCA)	June 9, 2016 / City FTP (background data Part 1.zip)	
✓	3. DEM/DTM for the study area (TRCA/City)	June 9, 2016 / City FTP (background data Part 1.zip)	This is superseded by the LiDAR.
		June 30, 2016 / BaseCamp sr130719.dwg	Channel bathymetry received (AMEC survey in Civil3D).
✓	4. Digital orthophotos/Aerial photos (TRCA/City)	June 9, 2016 / City FTP (background data Part 1.zip)	Included in 8. Historical Photos (up to Fall 2015).
		June 28, 2016 (CDs from Maggie - CD 1,2 and 3)	Spring 1994, 2000, 2004, 2008, 2012, 2015. Photos cover the full extent
✓	5. Building fabric and road network (City)	June 9, 2016 / City FTP (background data Part 1.zip)	Same data as in the land use folder (refer to Item 1.)
✓	6. SPA boundary (City)	June 28, 2016 (CDs from Maggie - CD 1)	
✓	7. Topographic information (TRCA/City)	June 9, 2016 / City FTP (background data Part 1.zip)	Numerous contours layers included in 3. DEM/DTM. These will be superseded by the LiDAR.
✓	8. Historical photos (TRCA/City)	June 9, 2016 / City FTP (background data Part 1.zip)	1946, 1954, 1958, 1967, 1976, 1978, 1981, 1983, 1989, 1993, 1999
✓	9. Precipitation and stream gauge locations and coordinates (TRCA)	June 9, 2016 / City FTP (background data Part 1.zip)	Stream gauge location here. Precipitation gauge location file missing.
		July 5, 2016 / email	Precipitation gauge attributes provided. Added to shape file manually.
✓	10. LIDAR data (TRCA)	June 8, 2016 / Basecamp (13475_BramptonDowntown.zip)	QA check complete.

TABLE A2 Data and Studies

	Data Description	Received Date/Method	Notes
✓	11. Etobicoke Creek Hydrology Update and VO2 model (TRCA)	June 9, 2016 / City FTP (background data Part 1.zip)	Report, output tables and models.
	12. Downtown Etobicoke Creek Revitalization Study (TRCA/City)	June 9, 2016 / City FTP (background data Part 1.zip)	Main report here.
✓	13. Central Area Sustainable Study, Phase 1 (City)	June 9, 2016 / City FTP (background data Part 1.zip)	
	14. Available site plan applications including servicing and grading plans (City)		
✓	15. TRCA floodplain mapping sheets (TRCA)	June 9, 2016 / City FTP (background data Part 1.zip)	Sheets etc22 to eto25. Pdf and digital.
✓	16. TRCA Manning's n table (TRCA)	June 9, 2016 / City FTP (background data Part 1.zip)	
✓	17. HEC-RAS models for Etobicoke Creek developed by TRCA and AMEC (TRCA)	June 9, 2016 / City FTP (background data Part 1.zip) December 1, 2016 / email January 9, 2018	Greck 2010 model. Valdor model received. Valdor reporting and floodplain mapping received
	18. As built drawings, photos and survey information for existing roads and crossing structures, if available (City)		
✓	19. Records of past flood complaints (City)	June 9, 2016 / City FTP (background data Part 1.zip)	Pdf figure.
	20. Background documents used to develop the HEC-RAS model, including boundary, flow nodes, and crossings data (TRCA)		For the Greck 2010 model.
✓	21. Subcatchment delineations (5 ha catchment from TRCA) (TRCA)	June 9, 2016 / City FTP (background data Part 1.zip)	10 ha catchments.
	22. CNR overpass design information, if available (City)		
	23. Outfall design details, if available (City)		
✓	24. Downtown Drainage Study Part 1 and Part 2 (City)	June 9, 2016 / City FTP (background data Part 1.zip)	
✓	25. Downtown Brampton Special Policy Area	June 9, 2016 / City FTP (background data Part 1.zip)	-

	Comprehensive Flood Risk and Management Analysis (City)		
--	---------------------------------------------------------	--	--

TABLE A3 Meteorological and Stream Flow Data, If Available

	Data Description	Received Date/Method	Notes
✓	26. Precipitation, temperature and stream flow data (TRCA)	June 9, 2016 / City FTP (background data Part 1.zip)	-
	27. High water marks, if available (TRCA)		
	28. Observed flow data at outfalls, if available (City)		

TABLE A4 Storm Sewer Data, If Available

	Data Description	Received Date/Method	Notes
✓	29. Drainage ditch/pipe/manhole/inlet/outfall types, sizes and material (City)	November 30, 2016 / email	Manhole survey completed on priority manholes, with manhole elevation, pipe direction, material, size and invert.
	30. Pipe lengths and slopes (City)		
	31. Inverts and top of grate elevations (City)		
	32. Relevant calculations (City)		
	33. As built drawings (City)		
	34. Drainage area plans (City)		
	35. Grading plans (City)		
✓	36. Computer model for existing storm sewer system (City)	June 9, 2016 / City FTP (background data Part 1.zip)	

TABLE A5 Sanitary Sewer Data, If Available

	Data Description	Received Date/Method	Notes
	37. Sanitary design data, including contributing area plans, pipe/manhole sizes, material, slopes, lengths, inverts and top of grate elevations (Peel)		
	38. Computer model for existing storm sewer system, if available (Peel)		Maggie has submitted request.

TABLE A6 Groundwater Data, If Available

	Data Description	Received Date/Method	Notes
✓	39. Groundwater levels from various studies and site plan applications (TRCA/City)	June 9, 2016 / City FTP (background data Part 1.zip)	-
	40. Recharge and discharge areas and rates (TRCA)		

TABLE A7 Others

	Data Description	Received Date/Method	Notes
✓	41. Woodlot (City)	June 9, 2016 / City FTP (background data Part 1.zip)	-
✓	42. Existing tunnel (City)	June 9, 2016 / City FTP (background data Part 1.zip)	-
✓	43. Flood Protection and Remedial Capital Works Program (TRCA)	June 9, 2016 / City FTP (background data Part 1.zip)	-

APPENDIX B
Manhole Survey Selection Memorandum

MEMORANDUM

TO: Maggie Liu, City of Brampton

FROM: Natalie MacDonald, Karen Hofbauer, Steve Braun, Matrix Solutions Inc.

SUBJECT: Selection/Identification Priority of Manholes for Surveying for Integrated Flood Risk Model Development

DATE: September 22nd, 2016

1 INTRODUCTION

As part of the Phase 2: Integrated Urban and Riverine Flood Risk Study, Matrix has reviewed the storm sewer network data provided by The City of Brampton (the City). A data gap analysis has been completed. The City has indicated their ability to complete survey operations for data gap filling. This memo provides recommendations for prioritized survey locations to minimize delays to the study schedule.

On July 14, 2016, the City provided Matrix Solutions Inc. (Matrix) with the sewer network shape files for the City. The City's sewer network has data gaps within the study area which are critical for the development of the model. While most of the pipe sizes and slopes have information, the invert elevations of the sewers are not available at this time.

Matrix has also reviewed the existing MOUSE model developed for the Downtown Drainage Study (2008) located within the study area contains sewer inverts determined from City design drawings. It is the preference of the City to survey the manholes to determine the sewer inverts rather than relying directly on historical design drawings or the Downtown Drainage Study model as the City has not reviewed the previous study for quality control.

Within the study area there are approximately 475 manholes. To keep the project on schedule and optimize the value of the surveying, Matrix has identified 52 key locations as priority for surveying based on several selection criteria. These priority manholes will serve to both verify the elevations used in the Downtown Drainage Study model and determine the elevations at critical locations within the study area where less information is available (outside of the Downtown Drainage Study model domain). An overview of the selection criteria, the strategy for selection and the priority survey locations are outlined in the following sections.

2 STRATEGY

Surveying all of the manholes within the site would delay the project and may provide limited additional value if the sewer elevations within the Downtown Drainage Study model are found to be adequate. Therefore it is Matrix's preferred strategy to prioritize the manholes for surveying to both obtain the elevations at critical locations required for developing the model and to verify the elevations used in the

Downtown Drainage Study model. Should the surveyed elevations agree with those in the Downtown Drainage Study model, the additional sewer inverts within the Downtown Drainage Study model can be applied where available. Where this is not applicable or should the Downtown Drainage Study model not be in sufficient agreement with the surveyed elevations, Matrix will interpolate sewer elevations between the surveyed locations. The sewer inverts for the less critical locations will be approximated by pipe slope and the invert elevation of upstream or downstream sewers.

3 KEY SITES

While inverts are needed for all pipes in the model, where sections of pipe are relatively continuous with little change they can be estimated from upstream or downstream pipes based on slope. There are several key locations where it is critical to have the proper elevation. These areas which are most critical for surveying include:

- Sewer outlets
- Manholes located at main sewer intersections
- Major changes in pipe size
- Areas of concern.

Areas of concern may include areas where there is a lack of data or verification is needed around the pipe network. This is particularly of interest in the special policy area.

4 PRIORITY SURVEY LOCATIONS

The priority manholes identified by the process outlined above are shown in Figure 1. A summary of these locations and the reason for selection is presented in Table 1. The numbering provided in this table is arbitrary does not necessarily indicate priority.

Table 1 List of Priority Manholes

Priority Manhole	Reason for Selection
1	Pipe size change, intersection
2	Pipe size change, intersection
3	Intersection
4	Intersection, area of concern
5	Pipe size change, intersection
6	Intersection
7	Outlet
8	Upstream location within this system
9	Outlet
10	Upstream location within this system
11	Intersection
12	Intersection
13	Intersection
14	Area of concern, upstream location
15	Area of concern, intersection

16	Pipe size change
17	Outlet
18	Outlet, intersection
19	Key area of concern, multiple manholes
20	Area of concern
21	Area of concern
22	Area of concern
23	Piper intersections, multiple manholes
24	Intersection, pipe size change
25	Intersection, pipe size change
26	Intersection, pipe size change
27	Highpoint in sewer, check connection
28	Outlet
29	Intersection, Highpoint in sewer, check connection
30	Intersection
31	Intersection
32	Highpoint in sewer, check connection
33	Outlet
34	Intersection
35	Upstream location within this system
36	Outlet
37	Upstream location within this system
38	Outlet
39	Outlet
40	Intersection, Pipe size change
41	Intersection
42	Intersection
43	Intersection
44	Intersection, Pipe size change
45	Intersection
46	Intersection
47	Outlet
48	Intersection
49	Intersection, pipe size change
50	Intersection
51	Intersection
52	Confirm existence of this pipe

5 CONCLUSIONS

With invert data at the above noted locations we believe the minor system modelling can be completed with a reasonable amount of certainty. By estimating the inverts between these locations the model will perform adequately for flood risk estimation.

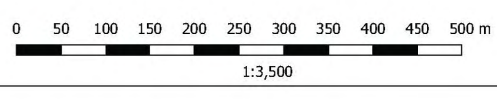
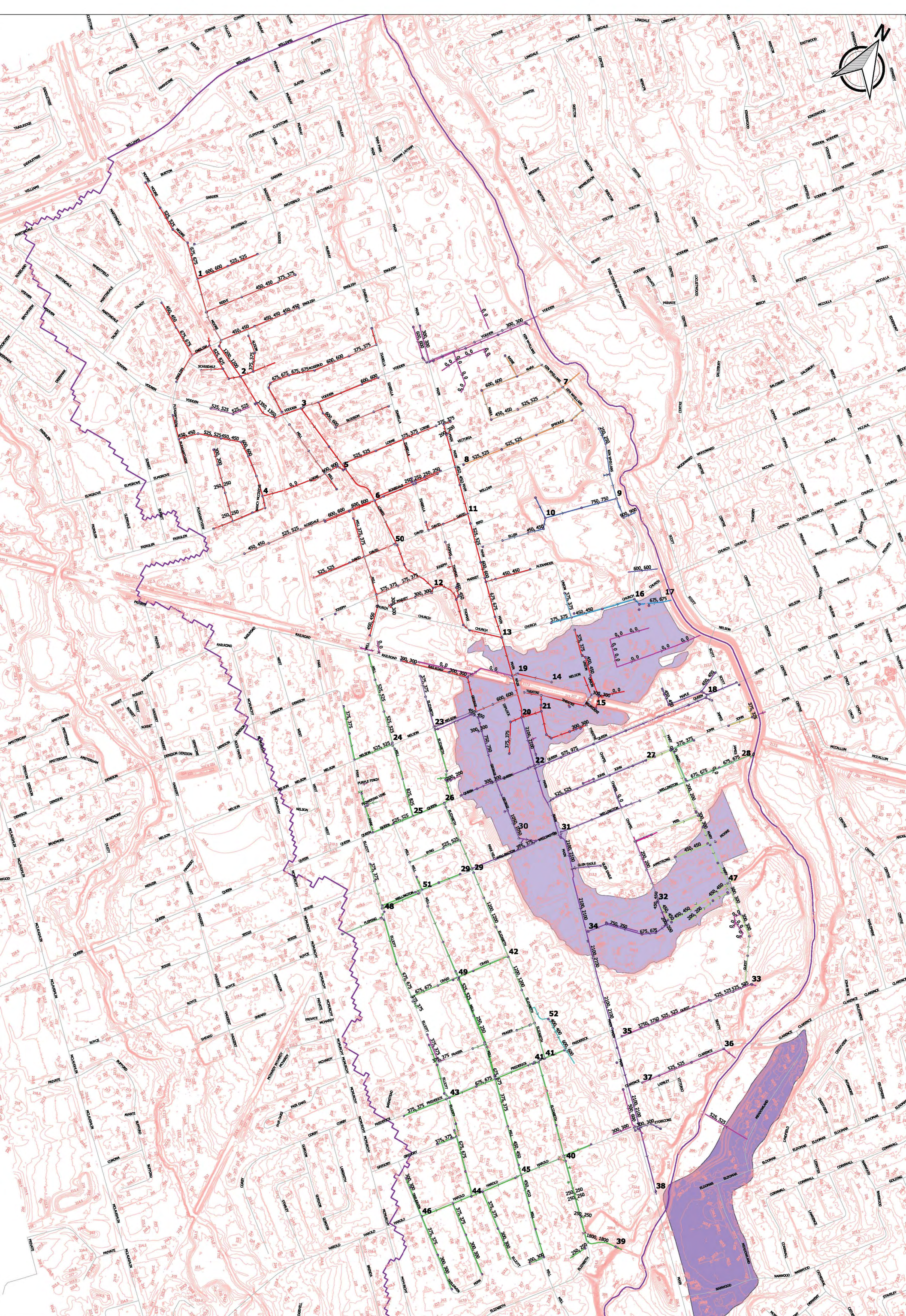

APPENDIX C
Sewer Infilling Memorandum

MEMORANDUM

TO: Maggie Liu, City of Brampton

FROM: Natalie MacDonald, Karen Hofbauer, Steve Braun, Matrix Solutions Inc.

SUBJECT: Infilling Sewer Data from Manholes Survey for Integrated Flood Risk Model Development

DATE: February 2nd, 2017

1 INTRODUCTION

As part of the Phase 2: Integrated Urban and Riverine Flood Risk Study, Matrix reviewed the storm sewer network data provided by The City of Brampton (the City). Data gaps critical for the development of the urban model were identified within the study area, particularly the lack of invert elevations of the sewers. Matrix also reviewed the existing MOUSE model developed for the Downtown Drainage Study (DDS) (2008). The Downtown Drainage Study model is located within the study area and contains sewer inverts determined from City design drawings. It was the preference of the City to survey the manholes to determine the sewer inverts rather than relying directly on historical design drawings or the DDS model as the City has not reviewed the previous study for quality control. To keep the project on schedule and optimize the value of the surveying, Matrix identified 53 key locations as priority for surveying based on several selection criteria. These priority manholes served to both verify the elevations used in the DDS model and determine the elevations at critical locations within the study area where less information is available (outside of the DDS model domain). The storm sewer survey was completed by the City and Matrix received the survey data on November 30th, 2016. A summary and review of the survey data collected, a comparison of survey data to the DDS model, and the process for infilling are outlined in the following sections.

2 SURVEY SUMMARY

In a memo to the City on September 22nd, 2016 entitled 'Selection/Identification Priority of Manholes for Surveying for Integrated Flood Risk Model Development', Matrix identified a list of priority manholes to survey. The 53 priority locations resulted in 70 manholes identified for surveying as some intersections of concern had multiple manholes. The survey was completed by the City and the survey data was returned to Matrix on November 30th, 2016. The survey crew measured the top of manhole elevation (m), the pipe size (inches) and the depth to pipe invert from the manhole lid elevation (inches). The pipe sizes and invert elevations were then converted to metric units. Through this method, a maximum accuracy of +/- 25 mm can be achieved.

Table 1 lists the survey locations, reason for selection, and notes on any observations or issues with the survey data.

Table 1 List of Priority Manholes

Priority Manhole	Reason for Selection	Comments on Survey Review
1	Pipe size change, intersection	
2	Pipe size change, intersection	Manhole not found
3a	Intersection	3a and 3b mixed up by surveyor
3b		3a and 3b mixed up by surveyor
4	Intersection, area of concern	
5	Pipe size change, intersection	
6	Intersection	
7	Outlet	
8	Upstream location within this system	
9	Outlet	
10	Upstream location within this system	Manhole not found
11	Intersection	
12	Intersection	
13	Intersection	
14	Area of concern, upstream location	
15a	Area of concern, intersection	Not correct pipes/manhole. Not included in analysis
15b		Not correct pipes/manhole. Not included in analysis
16	Pipe size change	
17	Outlet	
18a	Outlet, intersection	
18b		
18c		
19a	Key area of concern, multiple manholes	
19b		
19c		Manhole not found
20	Area of concern	Large contrast between documented pipe sizes and those surveyed. Not included in analysis.
21	Area of concern	
22a	Area of concern	These appear to be older pipes, not shown in GIS system. We were looking for the deeper trunks. Not included in analysis
22b		These appear to be older pipes, not shown in GIS system. We were looking for the deeper trunks. Not included in analysis
23a	Piper intersections, multiple manholes	23a and 23b mixed up by surveyor
23b		23a and 23b mixed up by surveyor
24	Intersection, pipe size change	
25	Intersection, pipe size change	
26	Intersection, pipe size change	
27	Highpoint in sewer, check connection	Confirmed not connected.
28	Outlet	Manhole was not surveyed. Measured culvert headwall.
29a	Intersection, Highpoint in sewer, check connection	
29b		Manhole not found
29c		Manhole not found
30	Intersection	
31a	Intersection	Data provided makes more sense at adjacent manhole.

31b		Manhole not found
32a	Highpoint in sewer, check connection	Two main sewers are not connected
32b		
33	Outlet	
34	Intersection	Data provided makes more sense at adjacent manhole.
35	Upstream location within this system	
36	Outlet	
37	Upstream location within this system	
38	Outlet	Deep chamber full of water
39	Outlet	Full of water
40	Intersection, Pipe size change	
41a	Intersection	
41b		
42	Intersection	
43	Intersection	
44	Intersection, Pipe size change	
45	Intersection	
46	Intersection	
47	Outlet	Full of water
48a	Intersection	
48b		Pipe directions/sizes differ
48c		Pipe directions
49a	Intersection, pipe size change	49a and 49b mixed up by surveyor
49b		49a and 49b mixed up by surveyor
50a	Intersection	
50b		
51	Intersection	
52a	Confirm existence of this pipe	Does not exist
52b		
53		

As evident from Table 1, some of the manholes identified for the survey could not be surveyed and some manholes surveyed were likely not the intended manhole. As such, in some location survey data were not used in the model at the intended location. Reasons for this include:

- Manhole did not exist
- Manhole could not be found
- Adjacent manhole surveyed
- Survey locations swapped (a and b)
- Manhole full of water
- Pipe not located (full of water, deep trunks, incorrect manhole)
- Incorrect pipe directions (may be recording error or may indicate incorrect manhole location)

The issue of manholes full of water or deep trunks not located could indicate maintenance concerns. The City should consider revisiting these locations to determine if standing water is a symptom of a blockage in the system.

3 COMPARING SURVEY TO DOWNTOWN DRAINAGE STUDY MODEL

Several manholes were surveyed within the DDS model study area in order to verify the existing model. Table 1 compares the invert elevations of surveyed manholes within the DDS model. Note that this excludes some locations where it was not confident that the survey picked up the correct pipes (e.g. locations 15 and 22). The median difference in invert elevation between the survey and the DDS model was 12 cm. As many of the locations were quite similar, Matrix proceeded to use the DDS model to infill inverts in areas where there was no survey. At a few locations the survey and the existing model differed by 30 cm or more (i.e. locations 5, 12, 18, 19, 32, and 50). Special attention was given to areas where the survey inverts and DDS model elevations did not agree. These were investigated individually and some are detailed further in Section 5.

Table 2 Comparison of survey inverts to Downtown Drainage Study model

Survey Location	Direction	Material	Survey Size	Survey Invert	DDS Invert	Difference	Absolute Difference
19b	North	Concrete	1950	209.215	209.214	-0.001	0.001
21	North	Concrete	900	209.425	209.42	-0.005	0.005
3a (3b)	West	Concrete	1500	214.93	214.936	0.006	0.006
3a (3b)	South	Concrete	1500	214.93	214.936	0.006	0.006
13	West	Concrete	1950	209.955	209.94	-0.015	0.015
5	South	Concrete	1650	214.175	214.2	0.025	0.025
13	South	Concrete	1925	209.83	209.856	0.026	0.026
19b	South	Concrete	1950	209.215	209.184	-0.031	0.031
21	West	Concrete	850	209.375	209.42	0.045	0.045
19b	West	Concrete	1150	210.44	210.38	-0.06	0.06
6	West	Concrete	625	214.99	215.05	0.06	0.06
11	North	Concrete	500	215.99	216.05	0.06	0.06
11	South	Concrete	500	215.99	216.05	0.06	0.06
50a	West	Concrete	525	214.445	214.51	0.065	0.065
31a (adjacent MH)	East	Concrete	375	209.79	209.86	0.07	0.07
31a (adjacent MH)	South	Concrete	375	209.64	209.71	0.07	0.07
18a	NW	Concrete	450	212.455	212.38	-0.075	0.075
4	South	Concrete	600	217.235	217.31	0.075	0.075
4	West	Concrete	300	217.235	217.31	0.075	0.075
6	East	Concrete	525	213.94	214.02	0.08	0.08
3b (3a)	West	Concrete	850	216.14	216.222	0.082	0.082
19a	East	Concrete	600	209.675	209.77	0.095	0.095
32 (a,b)	North	Concrete	450	208.72	208.816	0.096	0.096
3b (3a)	East	Concrete	850	216.24	216.35	0.11	0.11
14	Northwest	Concrete	600	209.985	210.1	0.115	0.115
30	Southeast	Concrete	1000	208.23	208.11	-0.12	0.12
27	West	Plastic	250	213.83	213.7	-0.13	0.13
34	East	Concrete	725	206.17	206.03	-0.14	0.14
18a	East/South	Concrete	625	212.305	212.46	0.155	0.155

Survey Location	Direction	Material	Survey Size	Survey Invert	DDS Invert	Difference	Absolute Difference
11	West	Concrete	425	215.99	216.16	0.17	0.17
21	South	Concrete	600	209.6	209.42	-0.18	0.18
34	West	Concrete	700	206.045	205.86	-0.185	0.185
30	North	Concrete	900	208.355	208.16	-0.195	0.195
4	North	Concrete	600	217.26	217.46	0.2	0.2
4	East	Concrete	850	217.085	217.31	0.225	0.225
6	North	Concrete	1662.5	213.74	213.98	0.24	0.24
6	South	Concrete	1662.5	213.74	213.98	0.24	0.24
5	North	Concrete	1500	214.2	214.49	0.29	0.29
19b	East	Concrete	675	209.59	209.29	-0.3	0.3
50b	North	Concrete	1675	213.095	213.43	0.335	0.335
50b	South	Concrete	1675	213.095	213.43	0.335	0.335
12	Northwest	Concrete	1650	213.09	212.728	-0.362	0.362
5	West	Concrete	900	214.625	215	0.375	0.375
12	East	Concrete	1637.5	213.14	212.728	-0.412	0.412
18c	South	Concrete	500	213.125	212.7	-0.425	0.425
19a	West	Concrete	600	209.275	209.75	0.475	0.475
18c	North	Plastic	350	213.95	213.47	-0.48	0.48
50a	East	Concrete	525	214.02	214.51	0.49	0.49
18a	North/East	Concrete	450	213.205	213.93	0.725	0.725
32 (a,b)	South	Concrete	525	207.705	208.816	1.111	1.111

4 INVERT DATA FILLING

Following the review of available invert data from survey and the DDS model, a process was developed for infilling invert data for the model preparation. The methodology used for infilling pipe data is outlined as follows:

- 1) Use survey data where it exists and where there is confidence in the survey data
- 2) Where possible use two surveyed inverts to determine pipe slope.
 - a) Calculate missing inverts based on pipe slope between the surveyed points
- 3) Where only one survey invert is available, assume pipe slope based on ground slope.
 - a) Calculate missing inverts based on ground slope
 - b) In some cases this had to be divided into smaller lengths due to variations in ground slope.
- 4) Rare case where ground slope didn't match pipe flow direction, i.e. at reverse graded pipes which typically only occurred at upstream extents of the system

- a) Assume 0.2% pipe slope to calculate missing inverts
- 5) In areas within the DDS study area and where no invert information is available from the survey, use inverts from the DDS model.
- 6) Exceptions made on a case by case basis to ensure:
 - a) acceptable level of cover
 - b) appropriate slope (and avoid reverse slope)
 - c) Reconcile differences in survey, City GIS layer pipe sizes, and DDS model.

5 SPECIAL CASES

At a few locations the survey invert elevation data was not used, or a combination of survey elevation data and DDS model elevations were used. These special cases arose when the surveyed data disagreed with either the DDS data and City's GIS layers, or when surveyed pipe inverts resulted in drainage issues. The resulting sewer data infill for these special cases have been illustrated in the figures in Appendix A.

6 OTHER PROCESSING

In addition to the sewer infilling of invert elevations, other GIS processing was required to prepare the model. This includes assigning upstream and downstream manholes to pipes, assigning catch basins to upstream manholes, and assigning catchment areas to catch basins. A few small sections of pipe were not included due to lack of information on the sewer or likely an abandoned sewer. In these cases catchments were reassigned a different manhole.

APPENDIX A

Note: Downstream pipe inverts highlighted in blue

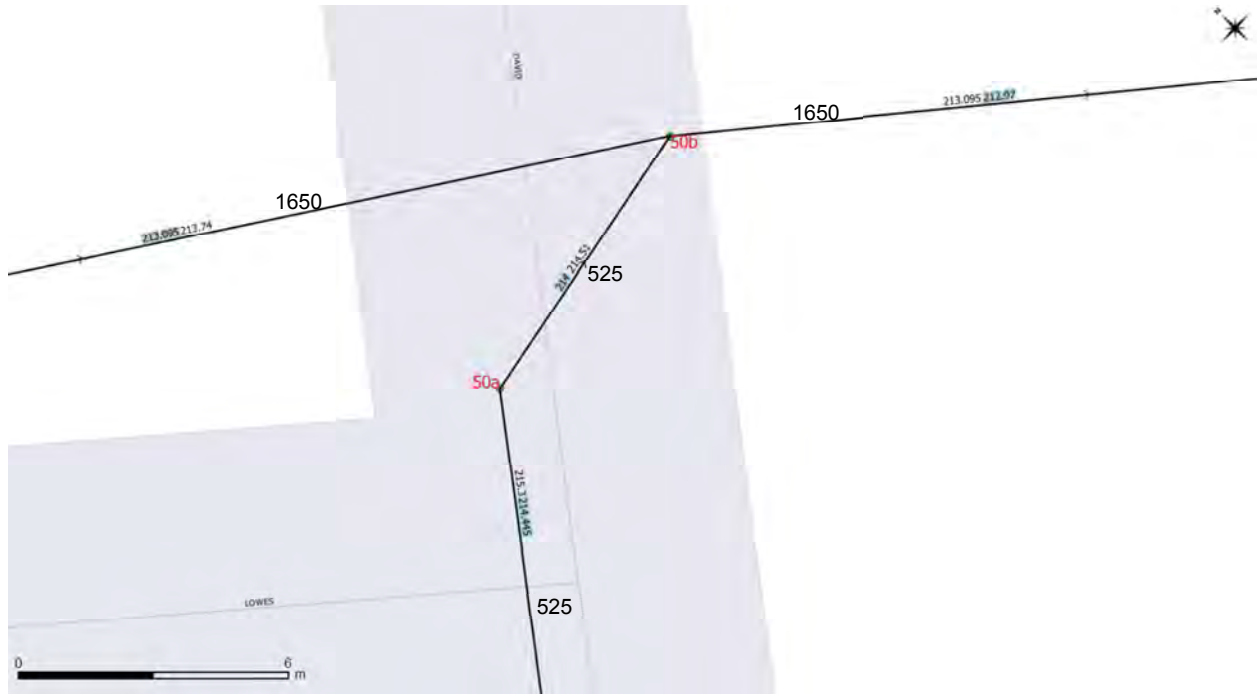

50 - Used survey except for pipe between 50a and 50b where survey and DDS model elevations differed by 50 cm and the survey was missing one measurement. On this length used DDS model inverts.

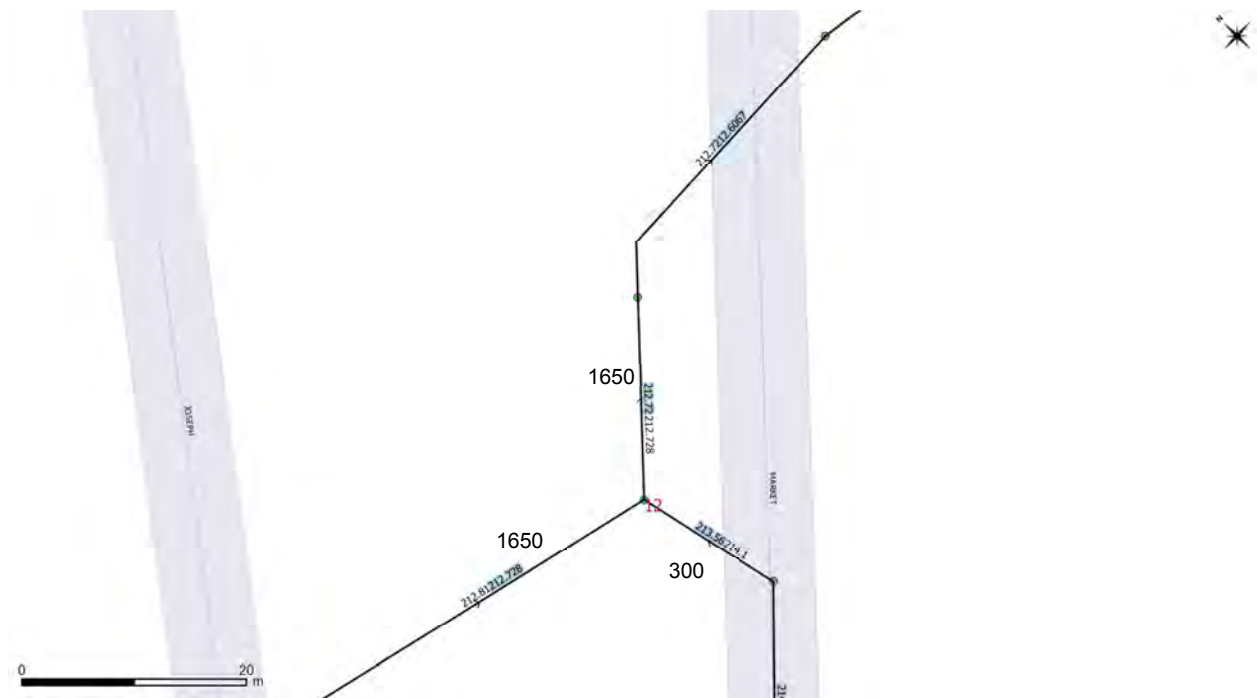

19a - Survey at 19a west differed significantly from DDS. Used East survey elevation as provided. Revised West elevation to equal the East elevation. This revised the surveyed reverse pipe slope between 19a and 19b.

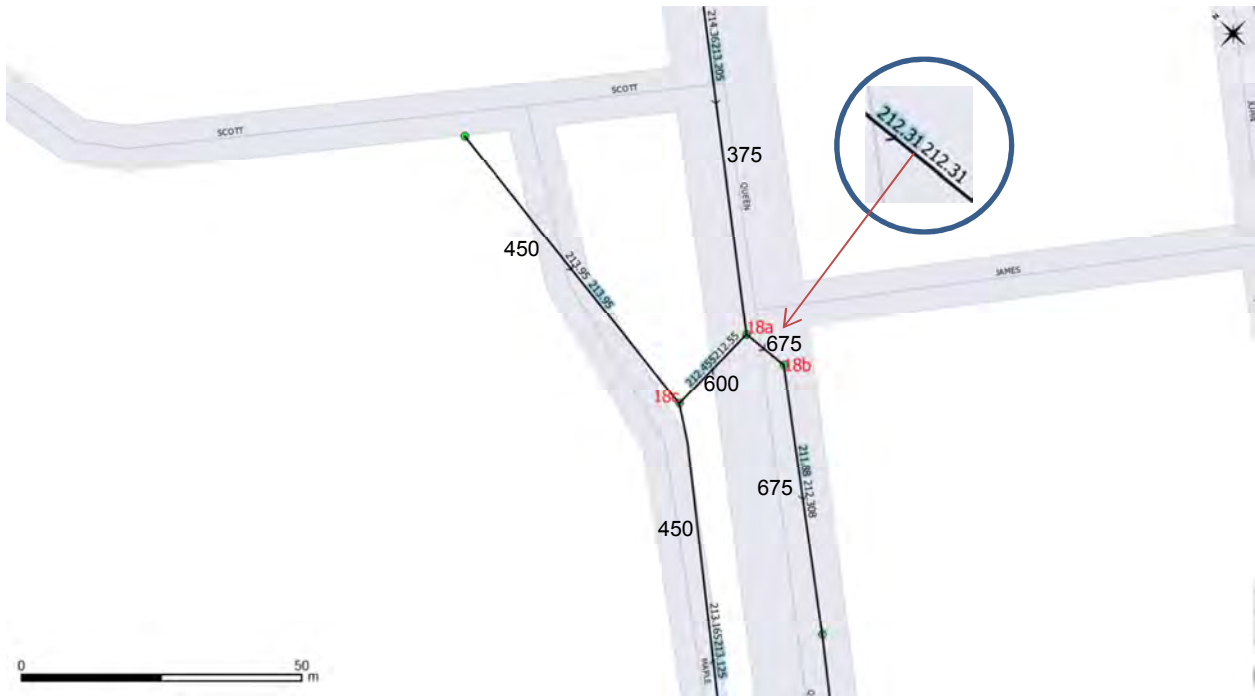

18 - Used pipe size data from DDS model but survey data for invert elevations. Discarded survey at 18B in order to ensure correct pipe slope. Infilled missing data with DDS inverts.



52 – Removed branch and routed catchments delineated from catchbasins to a downstream manhole where system would outlet.

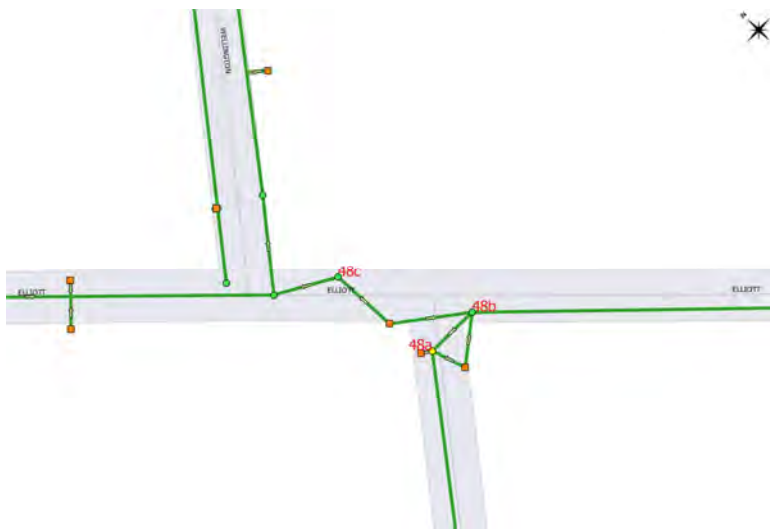

← GIS pipe configuration

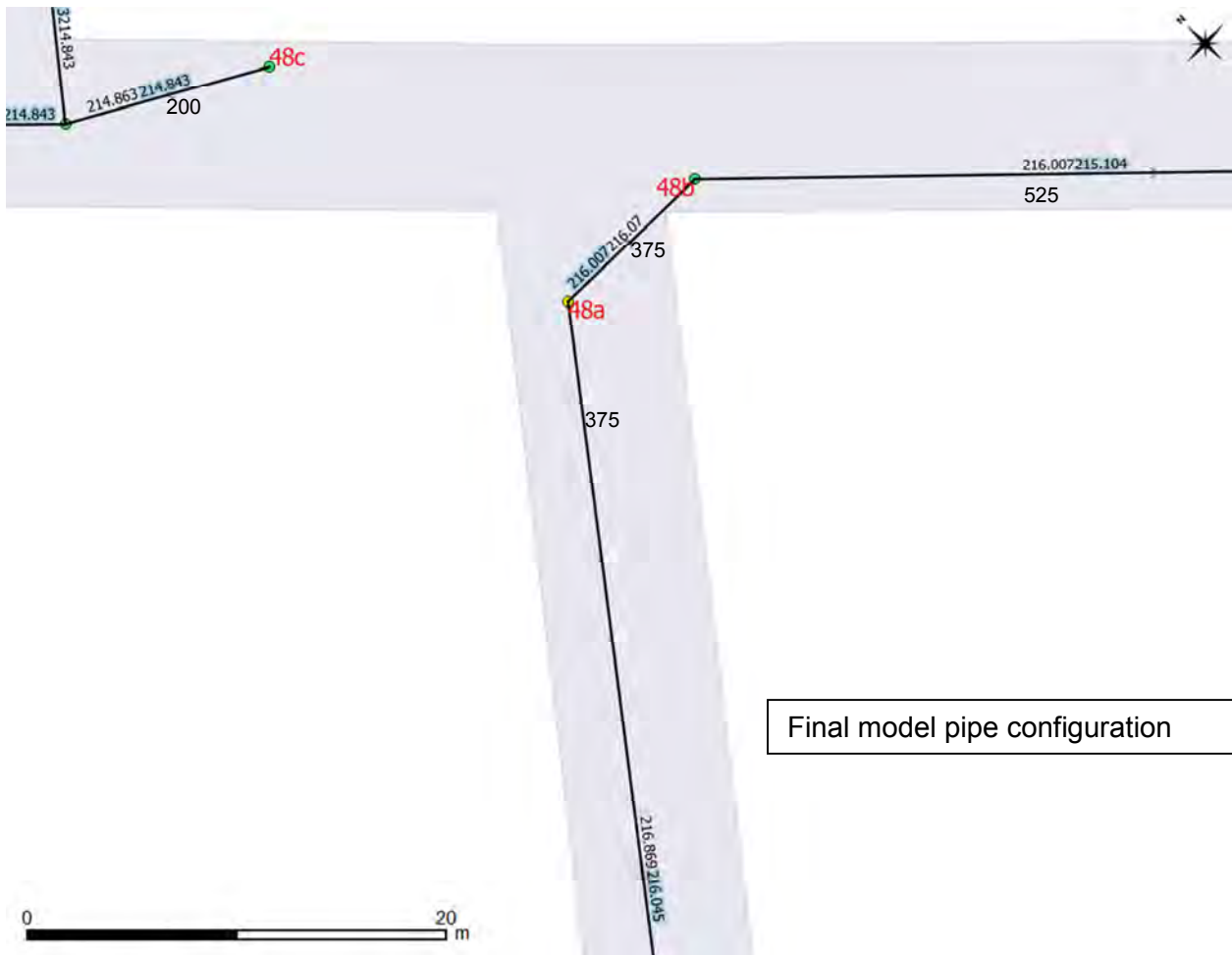

Final model pipe configuration

48 - Used survey on 48a. Pipe direction incorrect and pipe sizes differed to GIS, slope between 48a and 49. Direction is wrong at 49c. Calculated invert based on 0.2% slope up from next manhole.

APPENDIX D
Site Photographs



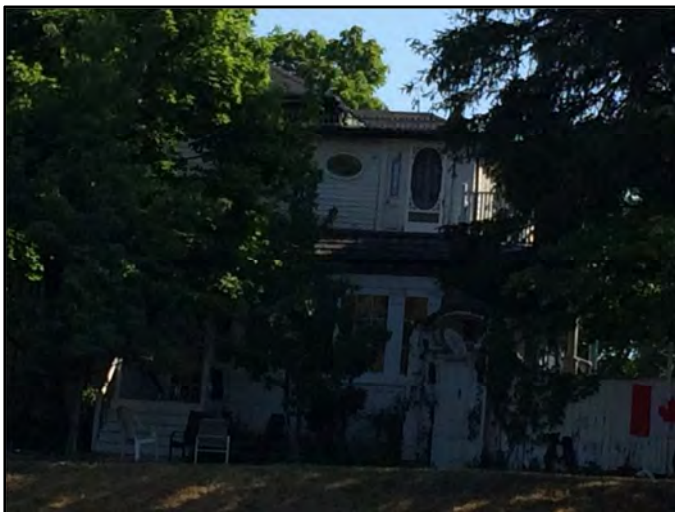

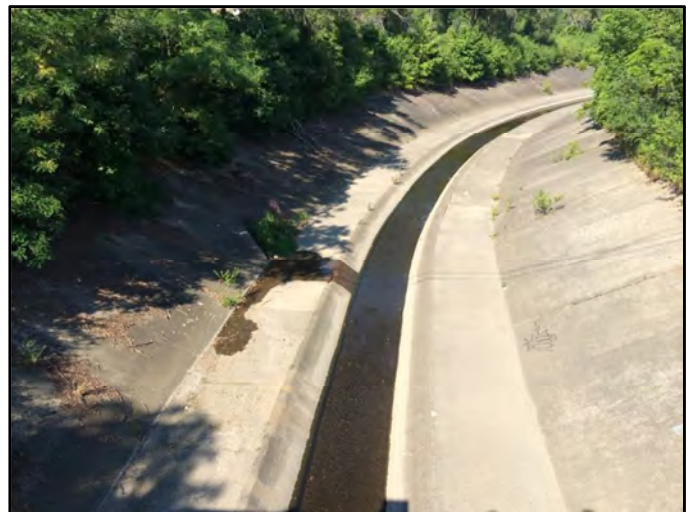
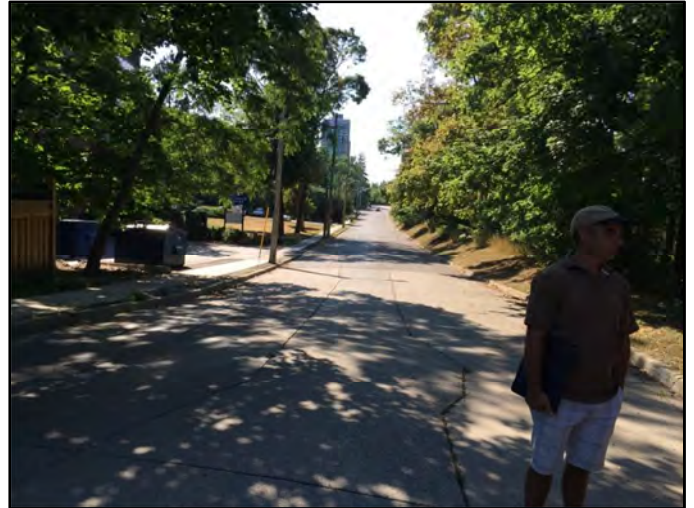







APPENDIX E
Burton Park Catchment Memorandum

MEMORANDUM

TO: Maggie Liu, City of Brampton

FROM: Natalie MacDonald, Karen Hofbauer, Steve Braun, Matrix Solutions Inc.

SUBJECT: Catchment Drainage to Fletcher's Creek at Burton Park

DATE: November 22nd, 2016

1 INTRODUCTION

As part of the Phase 2: Integrated Urban and Riverine Flood Risk Study, Matrix reviewed both the LiDAR and derived contours when determining the overland study boundary. Matrix compared the proposed study area to the catchments from the Etobicoke Creek hydrology model. Through detailed comparison it was determined that the residential area within and northwest of Burton Park included in the Etobicoke Creek hydrology study in fact drains to Fletcher's Creek. Figure 1 illustrates the 37 hectare area of concern which lies outside the overland flow boundary determined for the model domain but within the existing Etobicoke Creek hydrology catchments.

2 LIDAR REVIEW

A review of the LiDAR indicates flow from this area would be captured in Williams Parkway or if overtopped would be conveyed overland to Burton Park. There the flow would be captured in a ditch which runs along the back of the park. A berm is located behind the ditch, further increasing storage and preventing flow from entering the Burton Road residential properties. The ditch drains southwest to the other side of the railroad where it joins a large concrete channel which is a known tributary of Fletchers Creek. Figure 2 illustrates the location of three cross sections (presented as Figure 3) drawn across Burton Park, perpendicular to Williams Parkway and the drainage ditch. These cross sections illustrate that the ditch provides a meter of storage depth within the park. A profile (Figure 4) drawn down the ditch illustrates the slope of the channel.

A sensitivity analysis was completed using Visual Otthymo 4. Removing this 37 hectare catchment from the Etobicoke Creek watershed would result in a reduction in flow of $0.22\text{m}^3/\text{s}$ or -0.08% of the total flow at the study area for the Regional Storm or $3.37\text{m}^3/\text{s}$ (-2.74%) for the 350 year storm. All other storms fall within this range. After discussion during the biweekly Technical Conference Call on November 4th, a field visit was scheduled for November 15th to confirm the drainage before proceeding with modifying the Etobicoke Creek watershed boundary for this project.

3 FIELD INVESTIGATION

A site visit was conducted on November 15th, 2016. Attendees included Maggie Liu (City of Brampton), Nick Lorrain (TRCA), Robert Chan (TRCA) Steve Braun (Matrix) and Karen Hofbauer (Matrix). Site photos documenting the field visit are located in Appendix A. Discussions held on site determined agreeance that the catchment upstream of Burton Park will not flow through the current study area into Etobicoke Creek. This catchment will be removed from the hydrology model while determining flows for this study.

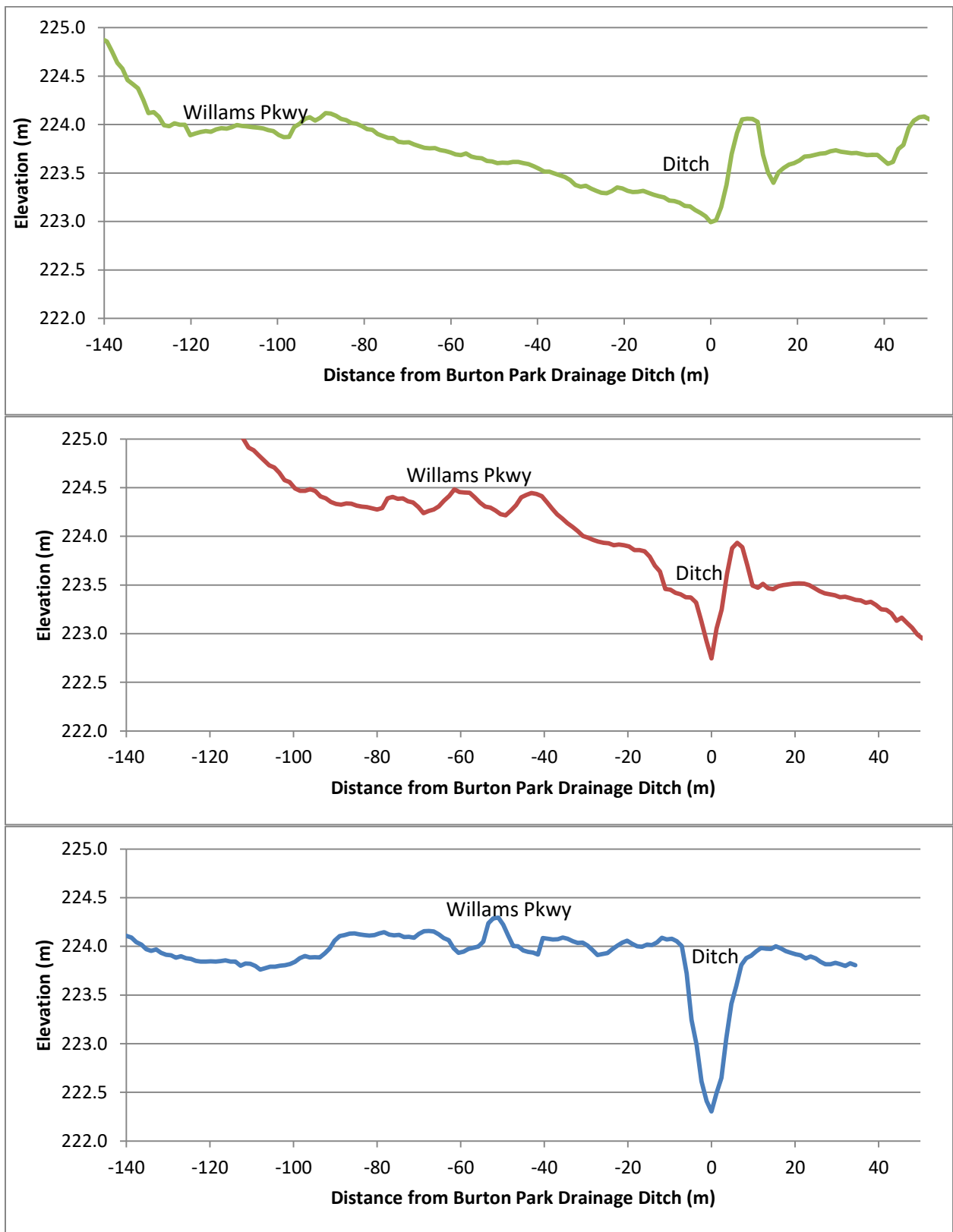

Figure 3. Cross sections through Burton Park as identified on Figure 2

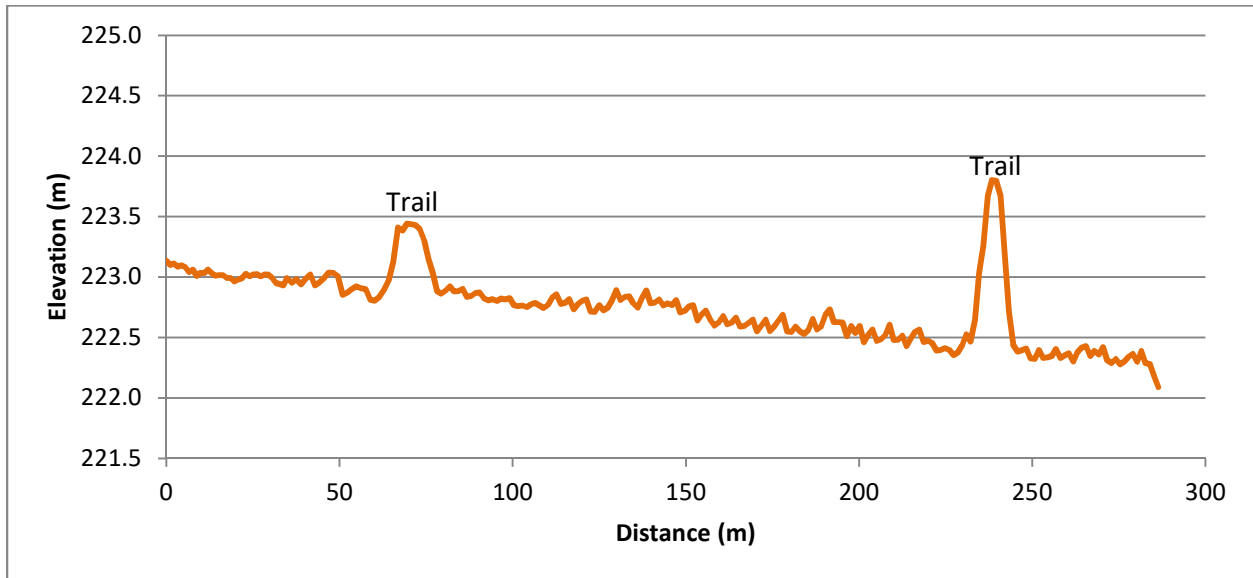

Figure 4. Channel Profile

4 MINOR SYSTEM

A review of the storm sewer system GIS data provided by the City indicates that the minor system flows from this catchment are conveyed to the west. The storm sewers in this catchment outlet into the culvert at the west (downstream) end of the channel in Burton Park and directly into the Fletcher's Creek tributary west of the railway. Figure 5 provides an overview of the minor system drainage in this catchment.

5 CONCLUSIONS

A review of LiDAR and a site visit confirmed the drainage direction of the neighbourhood to Fletcher's Creek. The Burton Park drainage area will be removed from the hydrology model and excluded from the inflows provided to the Mike11 model.



Legend

- Watercourse
- Etobicoke Catchments
- Streets
- Model Boundary
- Burton Park Catchment

0 50 100 150 200 250 m



City of Brampton: Integrated Riverine and Urban Flood Risk Analysis Project #22062







Burton Park Catchment

Disclaimer: The information contained herein may be compiled from numerous third party materials that are subject to periodic change without prior notification. While every effort has been made by Matrix Solutions Inc. to ensure the accuracy of the information presented at the time of publication, Matrix Solutions Inc. assumes no liability for any errors, omissions, or inaccuracies in the third party material.

N. MacDonald
Figure 1



Legend

- | | | |
|------------------------------------------------------------------------------------|-------------|---------------------------------------------------------------------------------------|
|  | Watercourse | Cross Sections |
|  | Streets |  a |
|  | Profile |  b |
| | |  c |



City of Brampton: Integrated Riverine and Urban Flood Risk Analysis Project #22062

Burton Park Cross Sections

Disclaimer: The information contained herein may be compiled from numerous third party materials that are subject to periodic change without prior notification. While every effort has been made by Matrix Solutions Inc. to ensure the accuracy of the information presented at the time of publication, Matrix Solutions Inc. assumes no liability for any errors, omissions, or inaccuracies in the third party material.

N. MacDonald
Figure 2

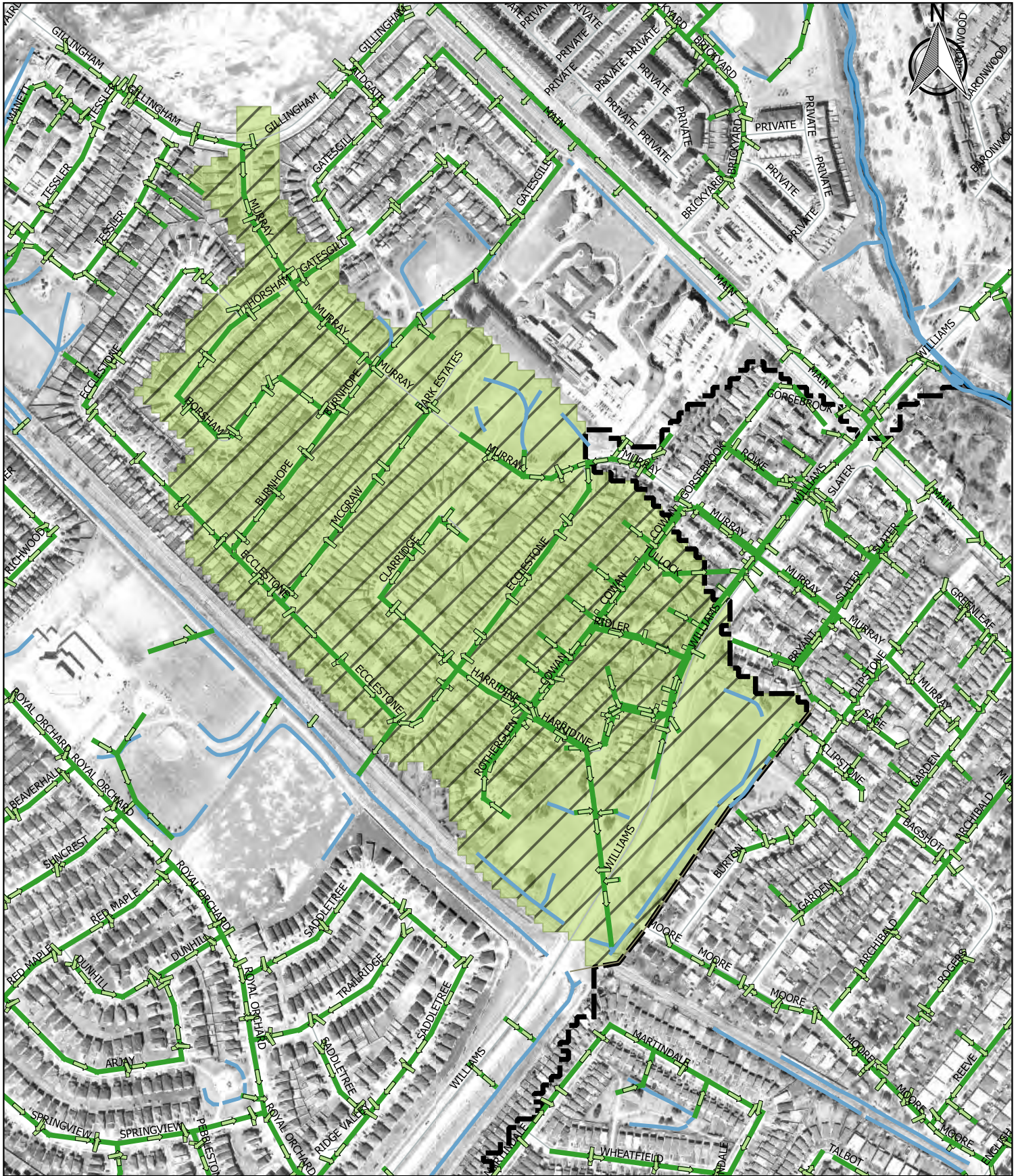

Legend

- Watercourse
- Streets
- Burton Park Catchment
- > Storm Sewer
- Model Boundary

0 50 100 150 200 250 m



City of Brampton: Integrated Riverine and Urban Flood Risk Analysis

Project #22062

Burton Park Minor System Schematic

Disclaimer: The information contained herein may be compiled from numerous third party materials that are subject to periodic change without prior notification. While every effort has been made by Matrix Solutions Inc. to ensure the accuracy of the information presented at the time of publication, Matrix Solutions Inc. assumes no liability for any errors, omissions, or inaccuracies in the third party material.

N. MacDonald

Figure 5





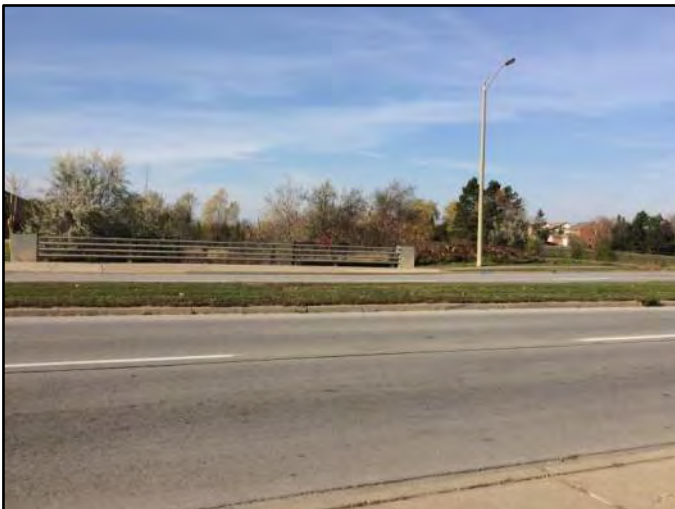

APPENDIX F
Preliminary Alternative Assessment Memorandum

MEMORANDUM

TO: Maggie Liu, City of Brampton

FROM: Karen Hofbauer & Kelly Molnar

SUBJECT: Preliminary Alternative Assessment

DATE: October 24, 2017

1 INTRODUCTION

The Phase 1 Study, titled *Downtown Brampton Flood Protection Feasibility Study* (AMEC, July 2016), focussed on the development and evaluation of a shortlist of flood mitigation alternatives. These alternatives were aimed at reducing or eliminating the Regional Storm flood risk in the Downtown Brampton SPA while being ecologically sensitive and sustainable. The study included flood characterization, and identification of spill and backwater conditions. It then considered flood mitigation alternatives for mitigation of the identified flood conditions. Both permanent and non-permanent alternatives were considered and include the following:

- Combination 1: A3 Ellen Street FPL + A4 Church Street Bridge Improvements + A6 Widen Bypass Channel through Church Street Bridge
- Combination 2: A3 Ellen Street FPL + Lower Bypass Channel
- A8 Tailwater FPL

The Phase 1 study included a HEC-RAS hydraulic assessment of these shortlisted alternatives; however, the conclusions recognized the limitations of the completed 1D modelling and recommended that future work incorporate 2D hydraulic modelling. That is the basis for the current Phase 2 study, along with the extra knowledge that will be obtained from coupling the effect of riverine flood plain with the urban storm sewer system and overland flow system.

2 REFINED FLOOD MITIGATION ALTERNATIVES

The existing flood characterization was conducted using the 3-way coupled MIKE FLOOD model, as detailed in Progress Report #3 (Matrix, October 2017). The 3-way model allows for analyzing the interaction of the creek with the overland topography as well as the urban sewer network.

From review of the 3-way model results and the existing flood characterization, there is a notable amount of urban flooding within downtown Brampton due to sewer backup and inlet capacity restriction during the design storm events, in addition to the known riverine spill during the Regional Storm. Both the urban flooding and riverine flooding follow the path of the historic river valley through the SPA, outletting back into the creek in the vicinity of Mary Street and Moore Crescent (see Map 1). From these findings it seems that provision of a tailwater FPL would essentially block the overland flow outlet to the creek and potentially exacerbate flood risk within the SPA. Therefore, efforts at this time

have been focussed on the other two short-listed alternatives. Other alternatives to address the tailwater spill require further review and discussion with the Technical Work Group.

Modelling has been initiated for two elements from the short-listed alternatives. To assess the hydraulic impact of these elements alone, two preliminary simulations were completed and are discussed in detail in the following subsections. The existing condition results (depth) for the major planning event (100-year Chicago-storm distribution applied to the urban system with Regional Storm applied to the riverine system) are provided in Map 1 for comparison purposes.

2.1 Ellen Street Flood Protection Landform

To assess the impact of the Ellen Street FPL, a preliminary simulation was completed. A crest elevation and slope grading for the flood protection landform was selected during the Phase 1 study based on the results of the HEC-RAS modelling (215.80 m). However, due to the difference in modelling techniques used in the present study, it is likely that the flood elevations from the MIKE FLOOD results would be different than that of HEC-RAS. To avoid the need to do multiple iterations of crest elevations, the MIKE FLOOD surface was updated to include a full obstruction (i.e., a wall set to 'land value') along the proposed crest location. This setup prevents water from overtopping the crest and allows for choosing an appropriate crest elevation based on the MIKE FLOOD results. It should be noted that detailed grading of the FPL was not completed at this time.

The results from the preliminary Ellen Street FPL simulation are provided in Maps 2.1 and 2.2 for the major planning event: Map 2.1 shows the water depth and Map 2.2 shows the difference in water depth compared to existing condition (FPL simulation minus existing conditions). Compared to existing conditions, the provision of the FPL causes the water elevation to increase by up to 1.0 m between Vodden Street and the downstream end of the bypass channel (see Figure 1). This increase can be attributed to the fact that the FPL forces flow to stay within the channel as opposed to spilling into the SPA, thereby increasing depth. The water depth near the FPL is approximately 3.0 m under planning event conditions. Considering that FPL grading was not done at this time, the crest elevation may need to be higher to accommodate grading of the river ('wet') side of the FPL; however, this provides a good starting point for future combinations with other measures. Increase in flood depths upstream of the FPL will need to be mitigated through combinations with other measures (e.g. bridge improvements, channel lowering etc.).

Significant improvements to flood levels within the urban area are noted downstream of the FPL within SPA3 (refer to Map 2.2) given implementation of the FPL. Urban flooding does remain in this area, however, the water depths between the FPL and Wellington Street decrease by greater than 1.0 m. Water levels through Gage Park show decreases between 0.25 and 1.0 m.

The urban flooding is primarily due to high water levels in the creek causing backup into the sewer network. Alternatives to consider for reducing sewer backup could include installation of check valves at the sewer outlets. These will prevent the riverine flood water from flowing up the sewers while allowing the sewers to outlet during normal riverine flow conditions. However, if a rainfall event in the urban area coincides with elevated riverine flows (as simulated with the planning event), the sewers would remain without an adequate outlet until the river flows recede (this would also be true under existing conditions).

While there is no increase in water elevation at the downstream end of the SPA, the results indicate an increase in backwater effect in the tailwater area. Again, this can be attributed to the fact that there is more flow in the channel and therefore more flow is able to backwater into the SPA in the vicinity of

Mary Street and Moore Crescent. Arguably, a tailwater FPL would prevent this backwater from occurring; however, it would also prevent the outflow of urban flooding from within the SPA. Therefore, further holistic consideration is required in regards to this flooding at this location. In the vicinity of Mary Street and Moore Crescent, where tailwater conditions cause backup from the creek, water depths decrease by up to 10 cm as a result of the Ellen Street FPL.

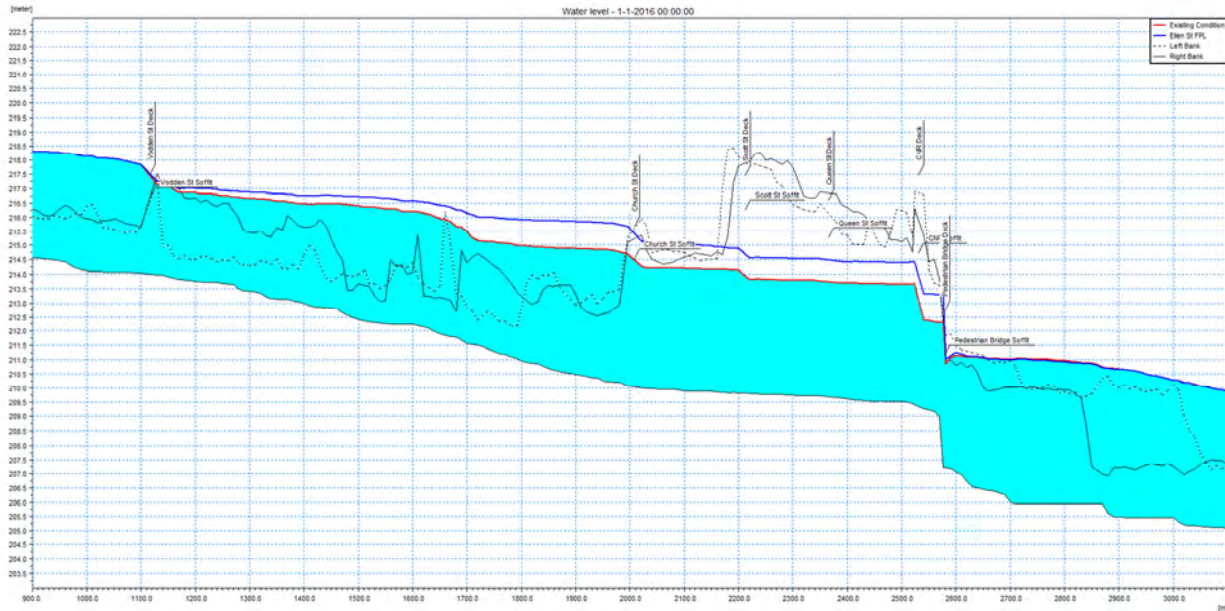

Figure 1 Longitudinal Profile Water Level Comparison – Ellen Street FPL vs. Existing Condition

2.2 Lower Bypass Channel

Consistent with one of the preferred options in the Phase 1 study, the bypass channel was lowered by 1.5 m from Church Street to its downstream end which is located at the pedestrian bridge crossing in Centennial Park. To accommodate the channel lowering, the bridge inverts within this reach were also lowered (Church Street, Scott Street, Queen Street, and the CNR). Matrix notes that the bridges in the model have not been widened to accommodate the channel lowering. Details of impacts to bridge structures would need to be considered in future studies.

The results of the lowered bypass channel for the major planning event are shown in Map 3.1 which indicates depth under channel lowering, and Map 3.2 which depicts the difference in depth compared to existing conditions. Map 3.2 makes clear that the most notable benefit of the channel lowering is in the upstream portion of the Downtown Brampton SPA from the river to the railway and at the intersection of George Street and Nelson Street, where there is greater than 15 cm decrease in water level. Between Theatre Lane and Wellington Street as well as in the vicinity of Ken Whillans Drive water levels decrease by 10 to 15 cm. Water levels within Gage Park (Wellington Street to Main Street) decrease by 5 to 10 cm. There is no significant reduction in water level in the tailwater area from Main Street to the river through SPA3; water levels decrease by less than 5 cm.

Lowering the bypass channel reduces the water elevation in the channel by up to 1.3 m (see Figure 2). However, the reduction in water elevation is localized to the bypass channel and does not propagate upstream of Church Street.

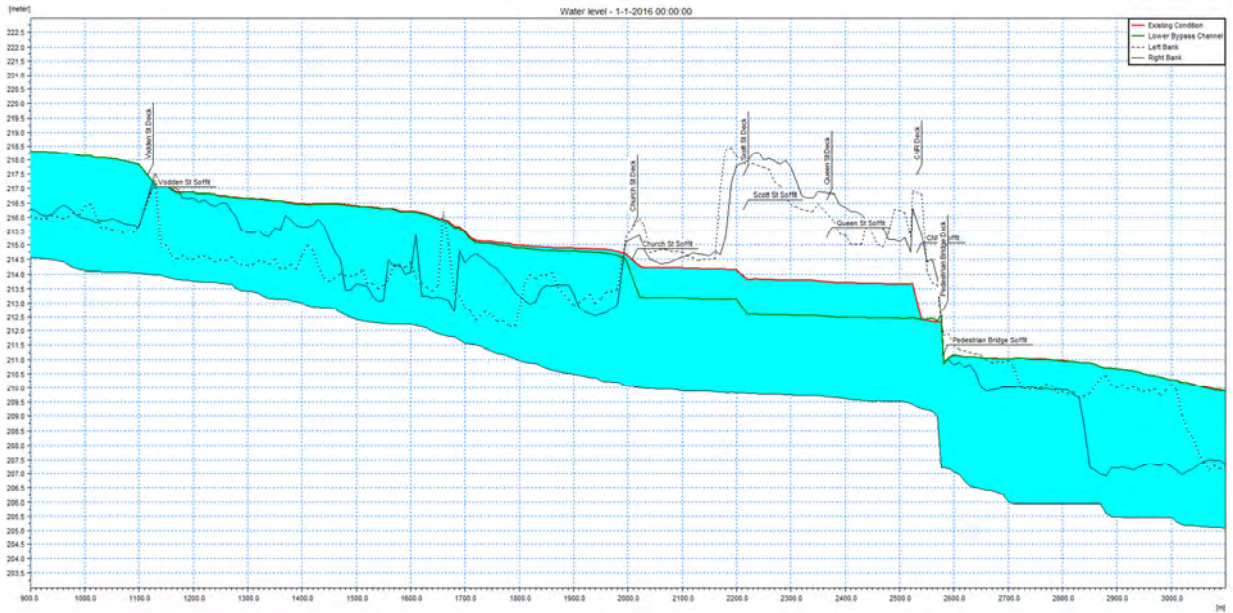

Figure 2 Longitudinal Profile Water Level Comparison – Lower Bypass Channel vs. Existing Condition

3 DISCUSSION

Based on the results of the two flood mitigation strategies discussed above, there is a need to explore additional alternatives.

Neither the FPL nor channel lowering alternatives on their own produce the desired reduction in flood levels through the Downtown Brampton SPA, however, examination of these preliminary results suggest that exploring combinations of the alternatives may yield more successful overall results. This was also recognized in the Phase 1 study in which combined alternatives were shortlisted.

The provision of an FPL combined with channel lowering would likely reduce backwater conditions for the urban system downstream of the FPL thereby reducing the amount of urban flooding within the SPA. Check valves may also be considered for the sewer outlets to the creek to reduce the probability of backwater propagating into the urban drainage system.

The FPL scenario results indicate tailwater conditions in the vicinity of Mary Street and Moore Crescent are causing backwater flooding in this area. Options to reduce backwater in this area should be explored and discussed with the Technical Work Group. A reduction in water levels in the creek downstream of the tailwater area would be required to reduce the amount of backwater. Some options for this were discussed during our last teleconference. These included channel improvements downstream and expanding the Clarence Street bridge.

Discussion during our last teleconference included the feasibility of extending the channel lowering further upstream to provide benefits in the area of the spill upstream of Church Street. Further direction is required from the Technical Working Group before Matrix proceeds with modeling of additional scenarios.

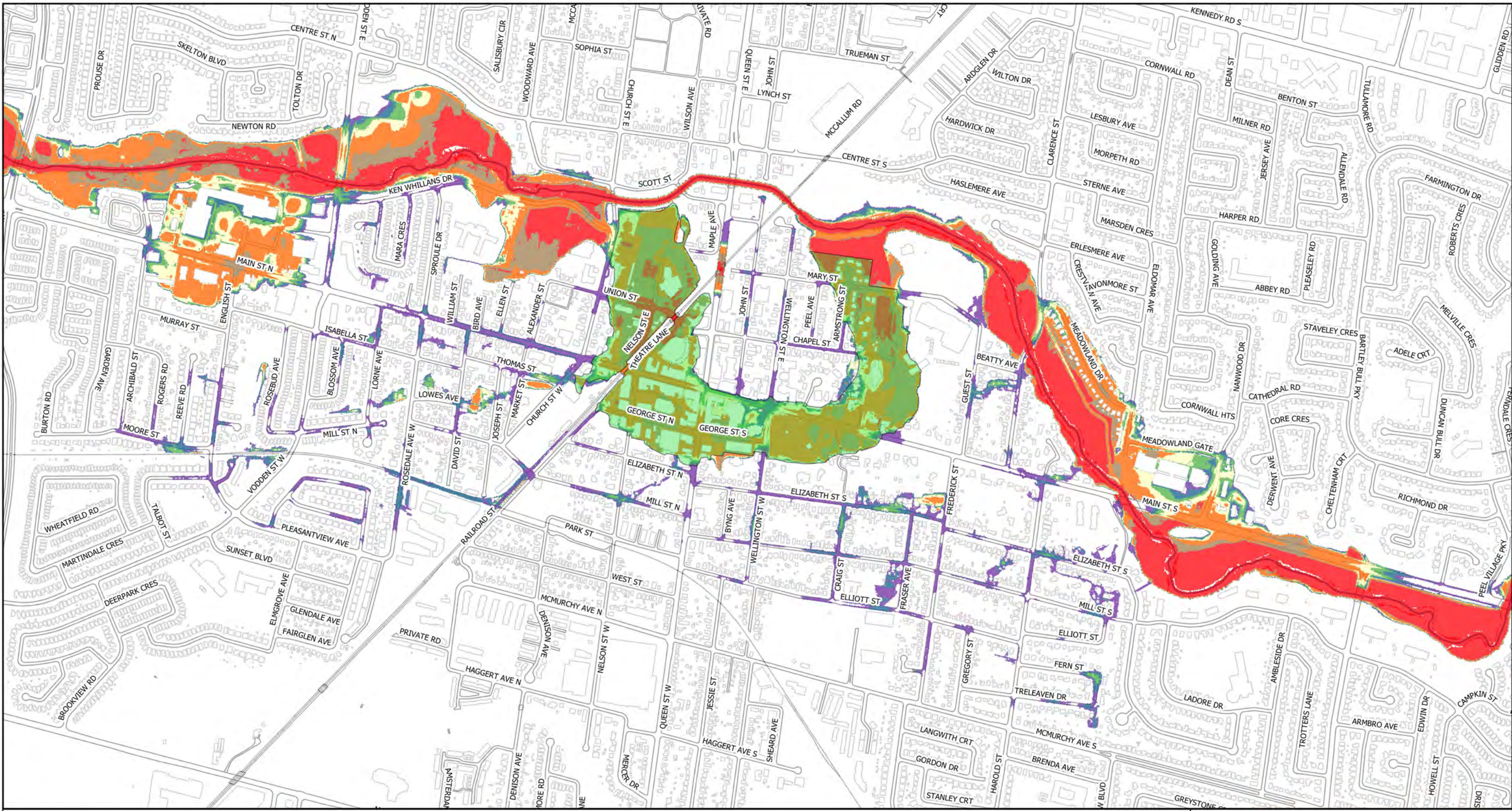

Run Date: August 20, 2017
 Figure Date: October 10, 2017

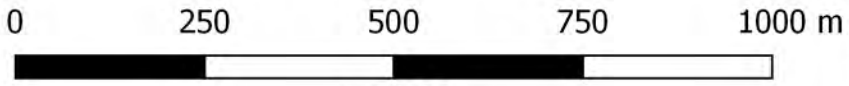
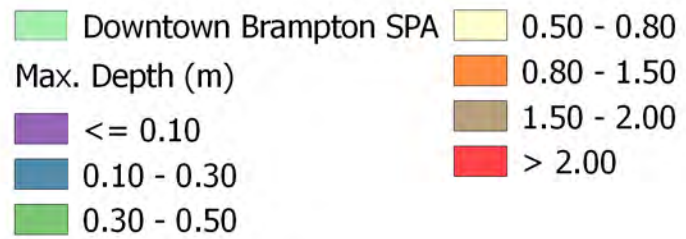

1:10,000

Matrix Solutions Inc.
 ENVIRONMENT & ENGINEERING

Brampton Integrated Flood Study
 MIKE FLOOD Results

Project #22062

Urban: 100year Chicago, River: Regional Storm
 Existing Condition - Depth

Disclaimer: The information contained herein may be compiled from numerous third party materials that are subject to periodic change without prior notification. While every effort has been made by Matrix Solutions Inc. to ensure the accuracy of the information presented at the time of publication, Matrix Solutions Inc. assumes no liability for any errors, omissions, or inaccuracies in the third party material.

K. Molnar
 K. Hofbauer

Map 1

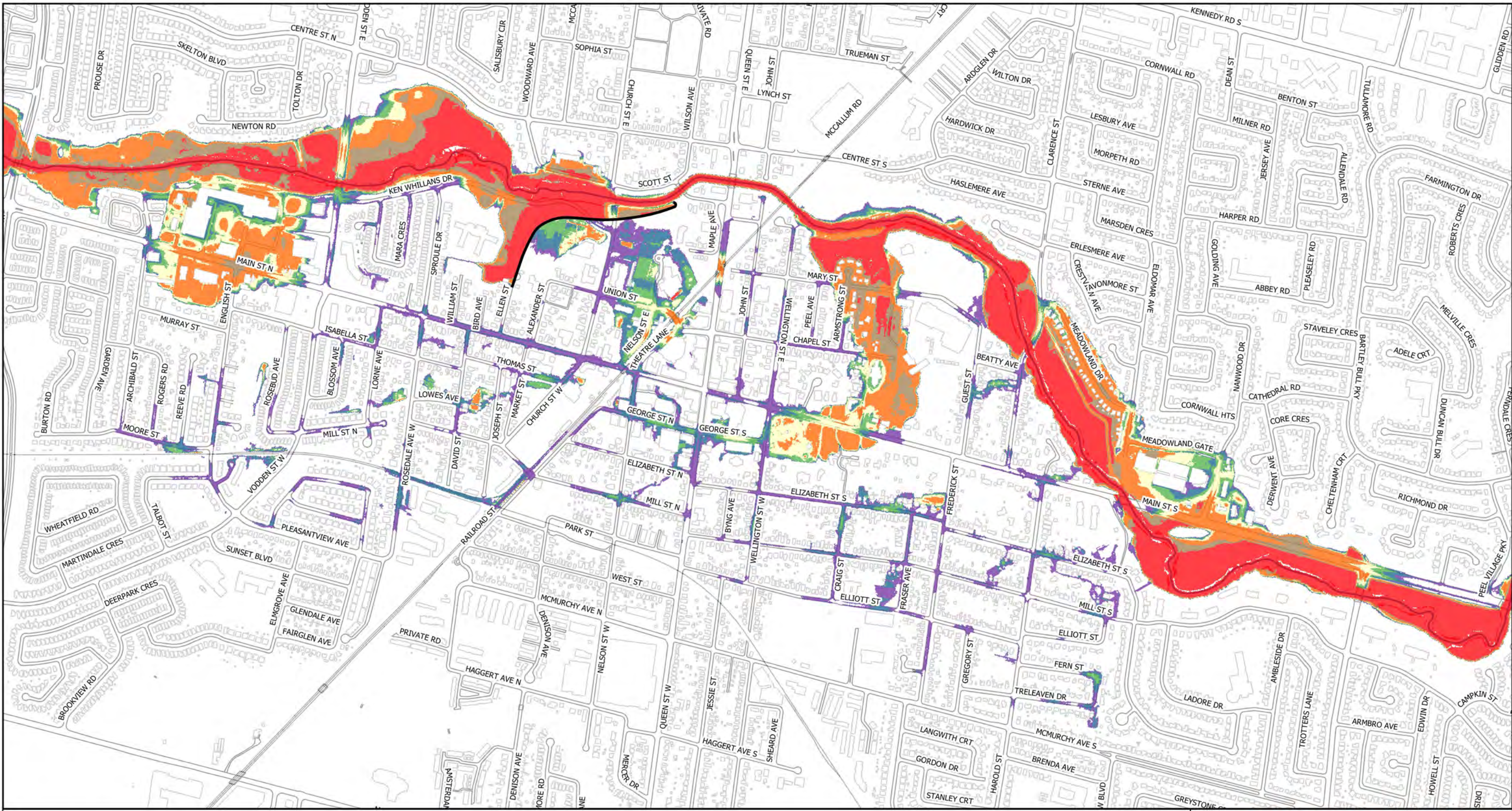

Run Date: September 20, 2017
 Figure Date: October 10, 2017

- | | |
|----------------------|---------------|
| █ FPL Crest Location | █ 0.50 - 0.80 |
| █ Max. Depth (m) | █ 0.80 - 1.50 |
| █ ≤ 0.10 | █ 1.50 - 2.00 |
| █ 0.10 - 0.30 | █ > 2.00 |
| █ 0.30 - 0.50 | |



0 250 500 750 1000 m

1:10,000



Brampton Integrated Flood Study
 MIKE FLOOD Results

Project #22062

Urban: 100year Chicago, River: Regional Storm
 Preliminary Ellen Street FPL - Depth

Disclaimer: The information contained herein may be compiled from numerous third party materials that are subject to periodic change without prior notification. While every effort has been made by Matrix Solutions Inc. to ensure the accuracy of the information presented at the time of publication, Matrix Solutions Inc. assumes no liability for any errors, omissions, or inaccuracies in the third party material.

K. Molnar
 K. Hofbauer

Map 2.1



Difference in Depth calculated by subtracting existing condition model results from proposed.

Run Date: September 20, 2017
Figure Date: October 10, 2017

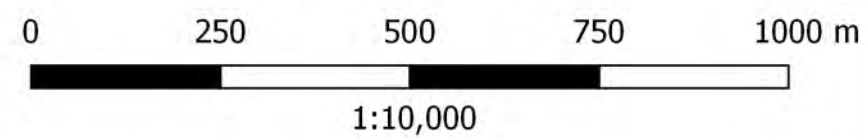
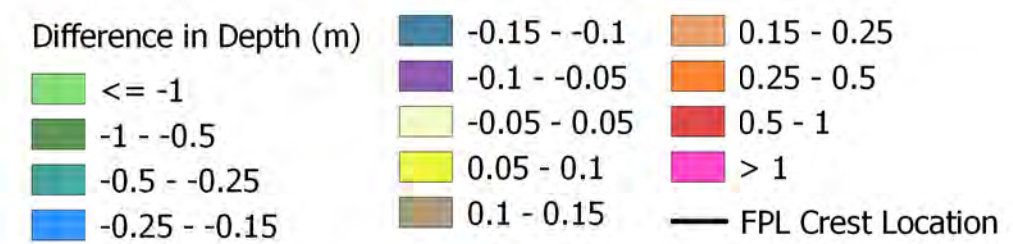

Matrix Solutions Inc.
ENVIRONMENT & ENGINEERING

Brampton Integrated Flood Study
MIKE FLOOD Results

Project #22062

Urban: 100year Chicago, River: Regional Storm
Preliminary Ellen St FPL - Difference in Depth

Disclaimer: The information contained herein may be compiled from numerous third party materials that are subject to periodic change without prior notification. While every effort has been made by Matrix Solutions Inc. to ensure the accuracy of the information presented at the time of publication, Matrix Solutions Inc. assumes no liability for any errors, omissions, or inaccuracies in the third party material.

K Molnar
K Hofbauer
Map 2.2



Run Date: September 27, 2017
 Figure Date: October 10, 2017

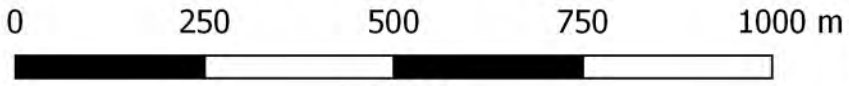
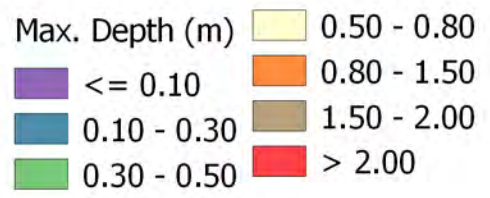

1:10,000

Matrix Solutions Inc.
 ENVIRONMENT & ENGINEERING

Brampton Integrated Flood Study
 MIKE FLOOD Results

Project #22062

Urban: 100year Chicago, River: Regional Storm
 Preliminary Channel Lowering - Depth

Disclaimer: The information contained herein may be compiled from numerous third party materials that are subject to periodic change without prior notification. While every effort has been made by Matrix Solutions Inc. to ensure the accuracy of the information presented at the time of publication, Matrix Solutions Inc. assumes no liability for any errors, omissions, or inaccuracies in the third party material.

K. Molnar
 K. Hofbauer

Map 3.1



Difference in Depth calculated by subtracting existing condition model results from proposed.

Run Date: September 27, 2017
 Figure Date: October 10, 2017

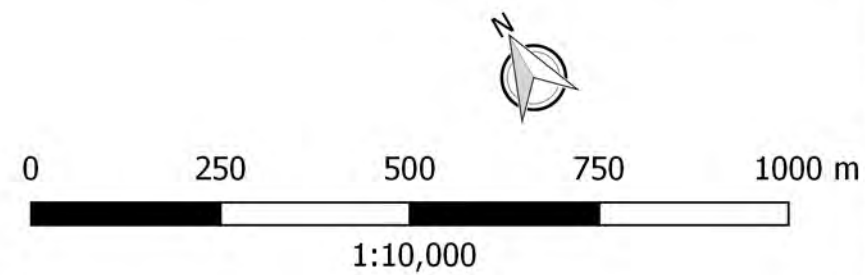
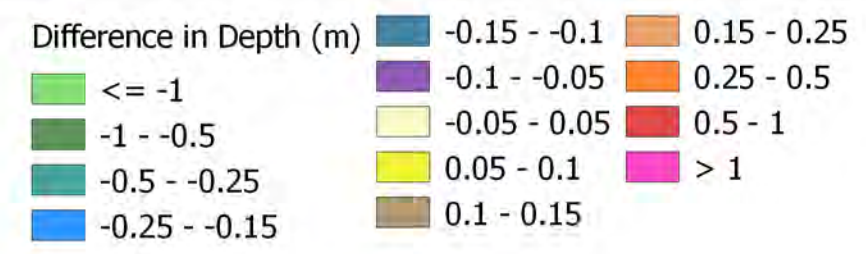

Matrix Solutions Inc.
 ENVIRONMENT & ENGINEERING

Brampton Integrated Flood Study
 MIKE FLOOD Results
 Project #22062

Urban: 100year Chicago, River: Regional Storm
 Prelim. Channel Lowering - Difference in Depth

Disclaimer: The information contained herein may be compiled from numerous third party materials that are subject to periodic change without prior notification. While every effort has been made by Matrix Solutions Inc. to ensure the accuracy of the information presented at the time of publication, Matrix Solutions Inc. assumes no liability for any errors, omissions, or inaccuracies in the third party material.

K Molnar
 K. Hofbauer
 Map 3.2

APPENDIX G

Bypass Channel Manning's n Assessment Memorandum

MEMORANDUM

TO: Maggie Liu, City of Brampton & Nick Lorrain, TRCA

FROM: Kelly Molnar & Karen Hofbauer

SUBJECT: Bypass Channel Manning's n Assessment

DATE: December 20, 2017

1 INTRODUCTION

The City of Brampton initiated the Integrated Riverine and Urban Flood Risk Analysis study to build upon previous studies, including the *Downtown Brampton Flood Protection Feasibility Study* (the Phase 1 Study, AMEC, July 2016), and to characterize the current flood risks in the Downtown Brampton Special Policy Area (SPA 3). The Phase 2 study analyzes the interactions between the existing urban drainage system and riverine flood waters within a fully integrated hydraulic model.

Part 1 of the study, focussed on hydraulic assessment of existing conditions and recommendations for future flood mitigation works, is nearing completion. Part 2 of the study, which is now underway, is focussed on the urban design component of downtown Brampton in support of the proposed Riverwalk. As part of the proposed Riverwalk, a number of urban design plans are being considered which have the potential to change the existing surface treatment (concrete) through the bypass channel (i.e., stepped features, plantings, etc.) which will have an impact on the channel roughness and therefore the hydraulic performance. This memorandum has been prepared to summarize the impact of increasing Manning's n through the bypass channel.

2 MANNING'S N ASSESSMENT

The roughness assessment has been undertaken using the available HEC-RAS model which was provided to Matrix by TRCA. The model was used during the flood mitigation alternative assessment to assess the effectiveness of various flood remediation scenarios prior to incorporating them into MIKE FLOOD. Using HEC-RAS for the Manning's n assessment allows for a more time-effective method of testing numerous scenarios as the run times are drastically shorter than that of the MIKE FLOOD model.

The Manning's n values selected for this assessment are consistent with TRCA standard parameters (see Attachment 1). The actual Manning's n value associated with various surface treatments proposed by the urban design team will be determined by TRCA in later studies.

2.1 Existing Cross-Section Width

The base case scenario used for this assessment is the "reconnected floodplain" scenario which includes realigning Ken Whillans Drive to the west to restore the natural floodplain upstream of Church Street. This scenario also includes lowering the bypass channel by 1.5 m along its length with a smooth transition (i.e., no drop structure) from the upstream existing bed elevation to the entrance of the

lowered bypass channel. Under this configuration all flows are conveyed through the bypass channel; there is no spill through SPA3.

To assess the hydraulic impact of various surface treatments through the proposed bypass channel, Manning’s n values were increased between cross-section 26.46 (immediately upstream of Church Street) and 26.375 (upstream of the pedestrian bridge). The Regional Storm results of the assessment are summarized in Table 1 and shown graphically on Figure 1. Note that for all scenarios the 1 m deep low flow channel portion was maintained as concrete with a Manning’s n of 0.013. Also, for comparison purposes with widening scenarios all bridges along the bypass channel have been removed. As shown, increasing Manning’s n causes a substantial increase in water elevation through the bypass channel and for some distance upstream.

Table 1 Manning’s n Variations – Existing Cross-Section Width

Manning’s n	Max. Increase in WL (m)	Avg. Increase in WL (m)
0.013	-	-
0.025	0.55	0.11
0.035	0.92	0.21
0.050	1.42	0.36

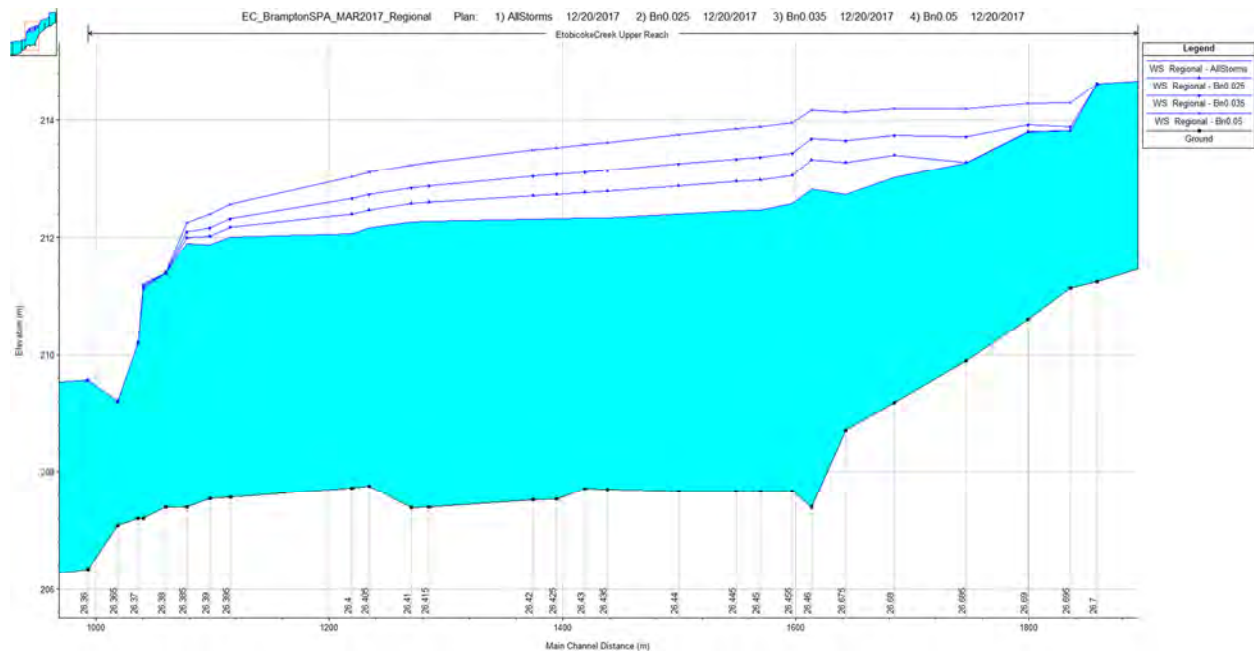

Figure 1 Longitudinal Profile – Existing Cross-Section Width

2.2 Widened Cross-Sections

An assessment was also completed to determine the channel width required to offset the increased depth associated with higher Manning’s n. Two trial scenarios were conducted: 1) with an increased base width of 10 m and 2) with an increased base width of 20 m. Under both scenarios the base width was increased along the length of the bypass channel and the 2:1 side slopes were maintained. Both trial scenario assessments also include the Manning’s n values of 0.013, 0.025, 0.035, and 0.05 (again, with the 1.0 m low flow channel maintained as concrete with n=0.013). The Regional Storm results for both

scenarios are summarized in Table 2 and are compared to the existing cross-section width and Manning’s n of 0.013. Note that the maximum and average increases in water level excludes the water elevations at cross-section 26.38 where the water profile passes through critical depth, as this is not associated with the increased Manning’s n and therefore skews the results.

The results are shown graphically in Figure 2 and Figure 3 for the 10 m and 20 m increases, respectively. As shown, the results of the assessment with increased base width indicate that increasing Manning’s n through the wider channel has a significantly smaller impact on water levels, particularly the 20 m widening. This is due to the fact that with a wider cross-section the head losses due to roughness are less significant.

Table 2 Manning’s n Variations – Increased Base Width

Manning’s n	10 m Increase		20 m Increase	
	Max. Increase in WL (m)	Avg. Increase in WL (m)	Max. Increase in WL (m)	Avg. Increase in WL (m)
0.013	0.00	-0.21	0.00	-0.16
0.025	0.00	-0.12	0.00	-0.12
0.035	0.04	-0.03	0.01	-0.07
0.050	0.49	0.10	0.11	0.01

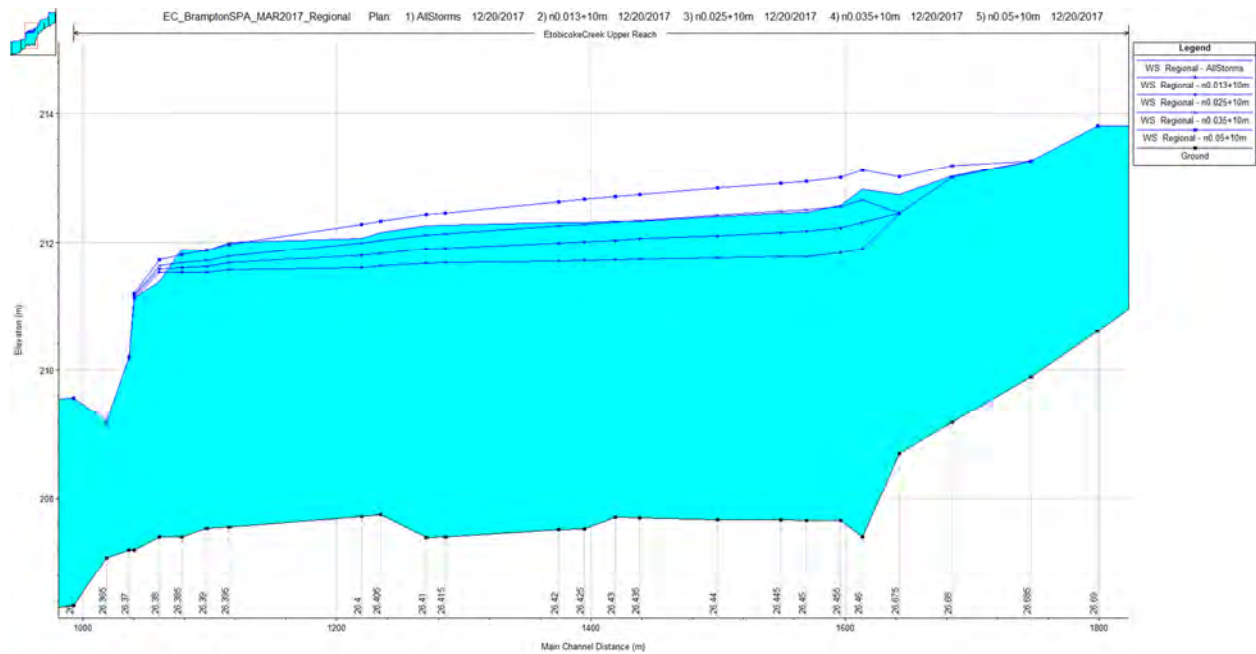

Figure 2 Longitudinal Profile – Width Increased by 10 m

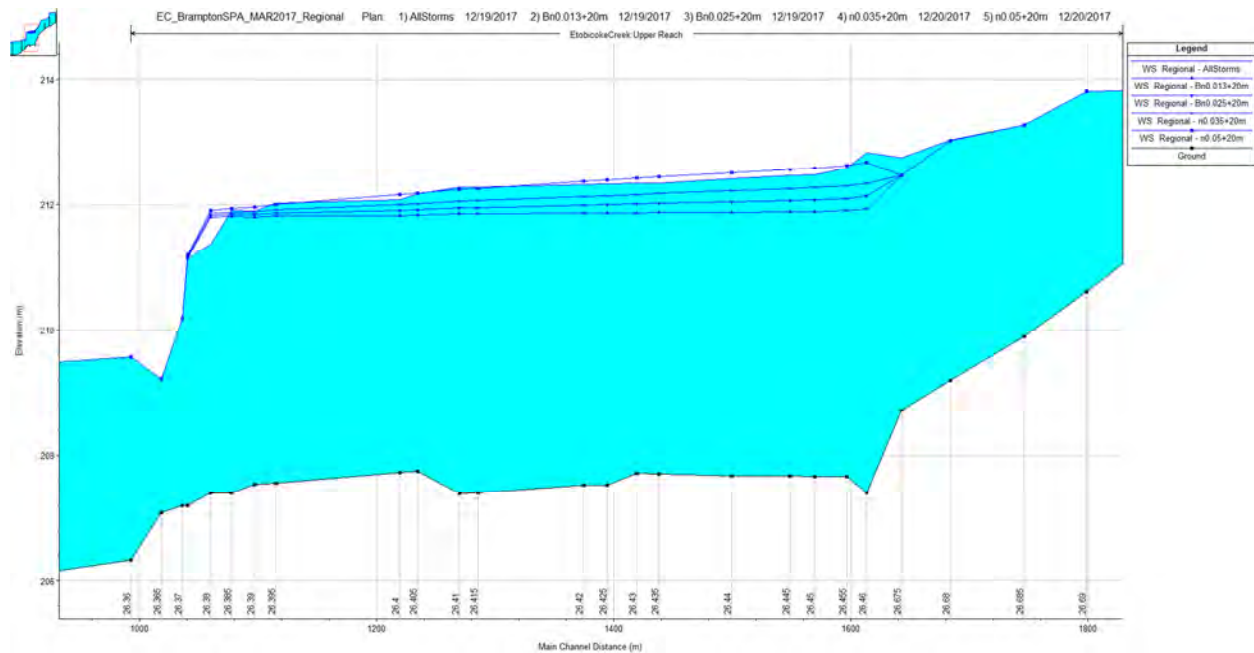

Figure 3 Longitudinal Profile – Width Increased by 20 m

3 CLOSURE

Moving forward, if a surface treatment other than concrete is proposed by the urban design team, the base width of the bypass channel will need to be increased to accommodate the increased roughness. The required increase will depend on the ultimate roughness, to be determined by TRCA. To accommodate increased roughness to a Manning's n of 0.05, the width would have to be increased by 20 m, while a Manning's n of 0.035 would require a 10 m increase in width.

Additionally, it is recommended that review of all structures along the bypass channel be conducted during the EA stage to assess the impacts of various bridge upgrades, as this assessment was conducted with no bridges modelled.

Standard Manning's Roughness Coefficients for TRCA Watershed Hydraulic Modelling		
Land Use	Description and Conditions	"n" Value ¹
Channel Component		
Watercourse/ Channel	<ul style="list-style-type: none"> low flow channel extends typically from bank to bank 	0.035
Hydraulic Structures	<ul style="list-style-type: none"> culvert crossings (e.g., corrugated metal, concrete open/closed footing etc.) bridge crossings 	Variable ²
Floodplain Component		
Urban Uses (Impervious)	<ul style="list-style-type: none"> Road crossings, existing parking lots or any large impervious surfaces etc. typically located within valley and stream corridors Does not include structures or buildings (to be modelled using available ineffective flow area options)² 	0.025
Urban Uses (Pervious)	<ul style="list-style-type: none"> <u>Existing</u> uses including municipal parks, playing fields, golf courses etc. typically located within valley and stream corridors Regular maintenance of area <u>is</u> required 	0.050
Natural Areas	<ul style="list-style-type: none"> Pasture, meadow, agricultural, riparian vegetation, brush and forest located within urban and/or rural land use setting typically located within valley and stream corridors <u>Not</u> subject to regular maintenance Assumes regeneration of open space type uses including pasture, meadow and agricultural uses within floodplain areas (Consistent with TRCA's VSCMP and Natural Heritage Strategies) 	0.080
Flood Control Channels	<ul style="list-style-type: none"> Flood control channels and associated works designed specifically for flood flow conveyance (eg., trapezoidal lined and un-lined channels etc.) "n" value based on original design or maximum allowable value determined through a sensitivity analysis Regular maintenance of area <u>is</u> required 	Variable ²

Notes: 1. Manning's "n" values represent average values based on literature data assuming flooding conditions.
2. Refer to HEC-2 and/or HEC-Ras User's Manual for further details.

APPENDIX H
Refined Flood Mitigation Measures Grading Plans

Plot 1:1 = Table 1 (L)
 N:\PROJECTS\22062 - City of Brampton Flood Study\05 Analysis\CAD\3D Production\Drawings\22062-3D Production\Drawings\01_05_Jan 2018.dwg - Upstream Option A_02_Sections - Tuesday, January 16, 2018 11:14:26 AM - Alexander Miazek

Cross Sections SL1

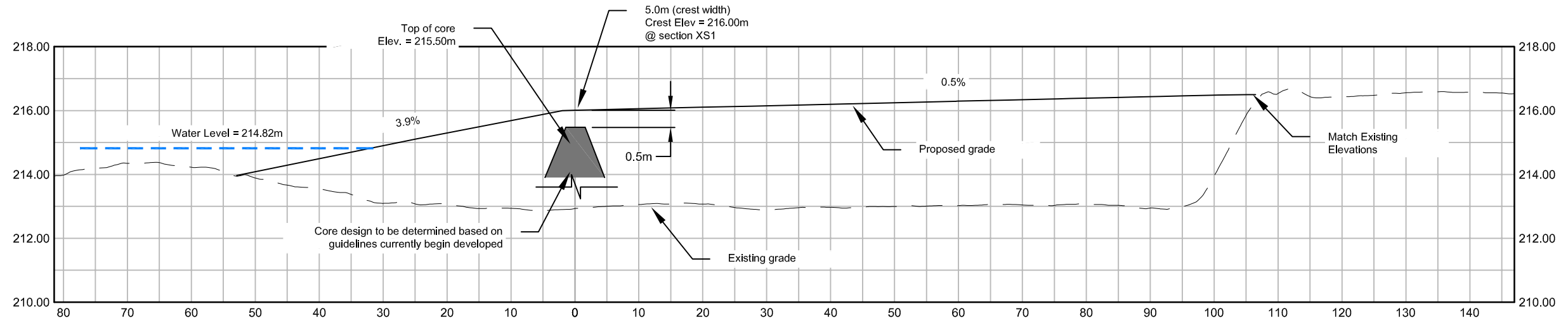

SL2

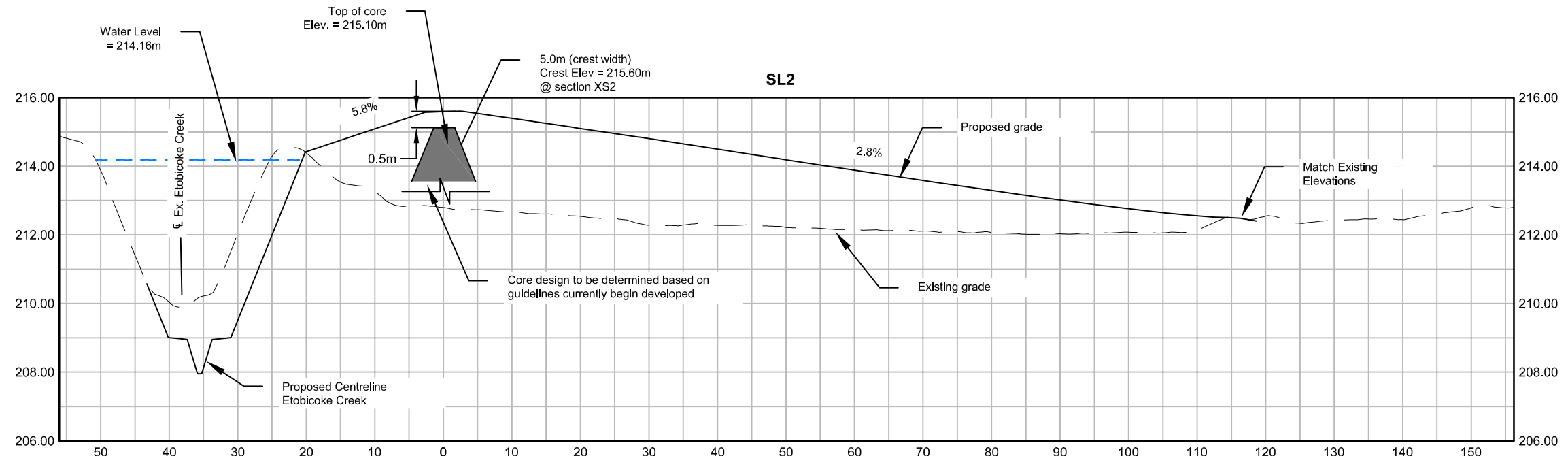

Legend	
	Existing ground
	Proposed Grade

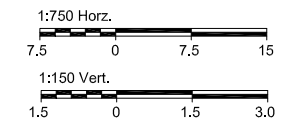

Brampton Floodplain Study

Upstream Option A: Ellen St. Flood Protection Landform (A3) Sections SL-1 AND SL-2

Date: 13/07/2017 Project: 22062 Technical: Reviewer: Drawn:

Disclaimer: The information contained herein may be compiled from numerous third party materials that are subject to periodic change without prior notification. While every effort has been made by Matrix Solutions Inc. to ensure the accuracy of the information presented at the time of publication, Matrix Solutions Inc. assumes no liability for any errors, omissions, or inaccuracies in the third party material.

N:\PROJECTS\22062 - City of Brampton Flood Study\05 Analysis\CAD\Civil 3D\Production Drawings\22062-Site Grading\05_06 Jan 2018.dwg - Upstream Option B_03 - Monday, January 15, 2018 2:14:22 PM - Alexander Miszczak
 Plot 1:1 = Tabloid (L)

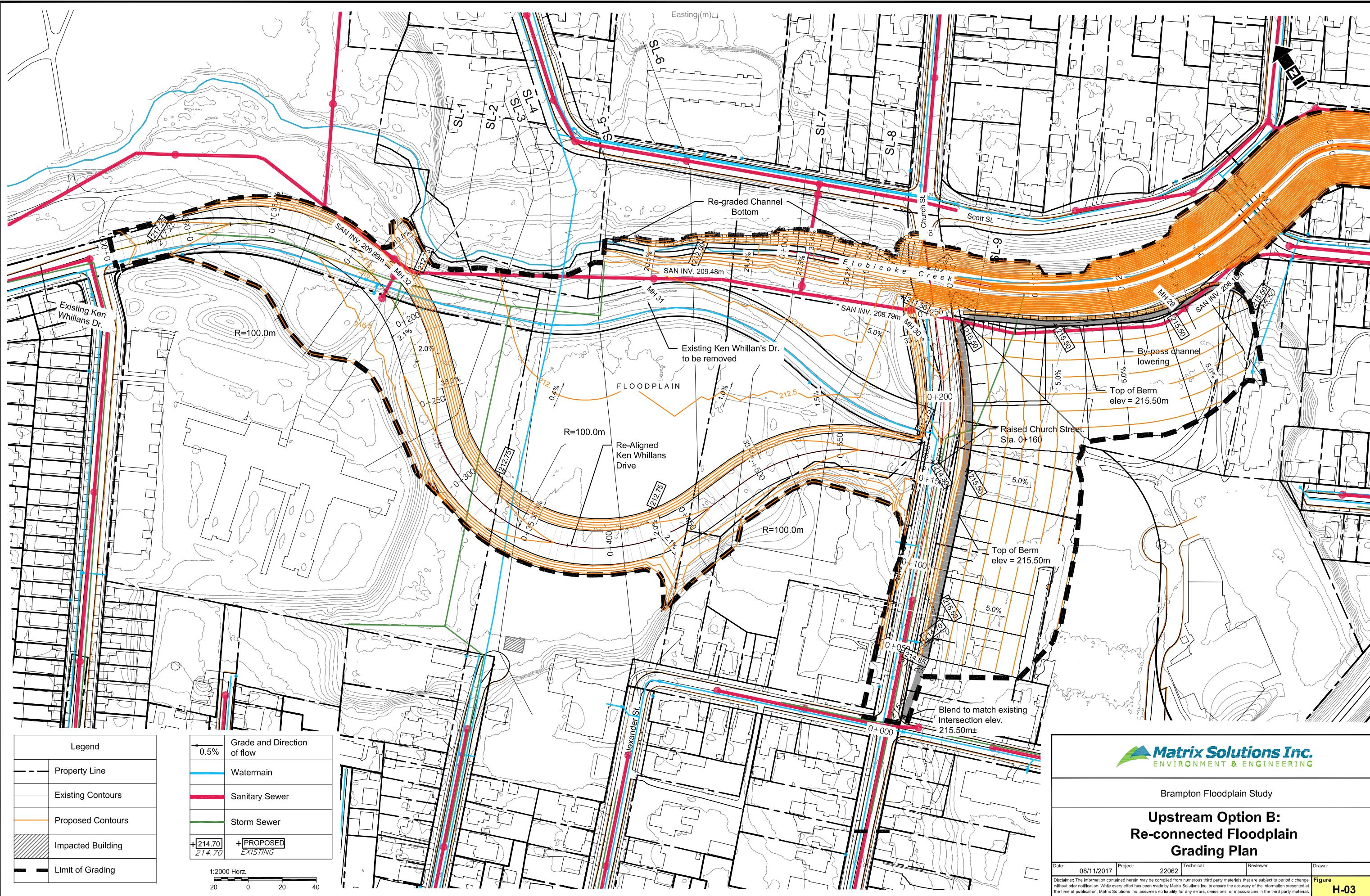

Legend					
	Property Line				
	Existing Contours				
	Proposed Contours				
	Impacted Building				
	Limit of Grading				
	Grade and Direction of flow				
	Watermain				
	Sanitary Sewer				
	Storm Sewer				
	<table border="1"> <tr> <td>+214.70</td> <td>+PROPOSED</td> </tr> <tr> <td>214.70</td> <td>EXISTING</td> </tr> </table>	+214.70	+PROPOSED	214.70	EXISTING
+214.70	+PROPOSED				
214.70	EXISTING				

1:2000 Horiz.

Matrix Solutions Inc.
ENVIRONMENT & ENGINEERING

Brampton Floodplain Study

**Upstream Option B:
Re-connected Floodplain
Grading Plan**

Date: 08/11/2017	Project: 22062	Technical:	Reviewer:	Drawn:
------------------	----------------	------------	-----------	--------

Disclaimer: The information contained herein may be compiled from numerous third party materials that are subject to periodic change without prior notification. While every effort has been made by Matrix Solutions Inc. to ensure the accuracy of the information presented at the time of publication, Matrix Solutions Inc. assumes no liability for any errors, omissions, or inaccuracies in the third party material.

Figure H-03

N:\PROJECTS\22062 - City of Brampton Flood Study\05 Analysis\CAD\CH\3D\Production Drawings\22062-Site Grading.dwg - Upstream Option B_04 - Monday, January 15, 2018 2:14:22 PM - Alexander Mieszczak
 Plot 1:1 = Table 1(L)

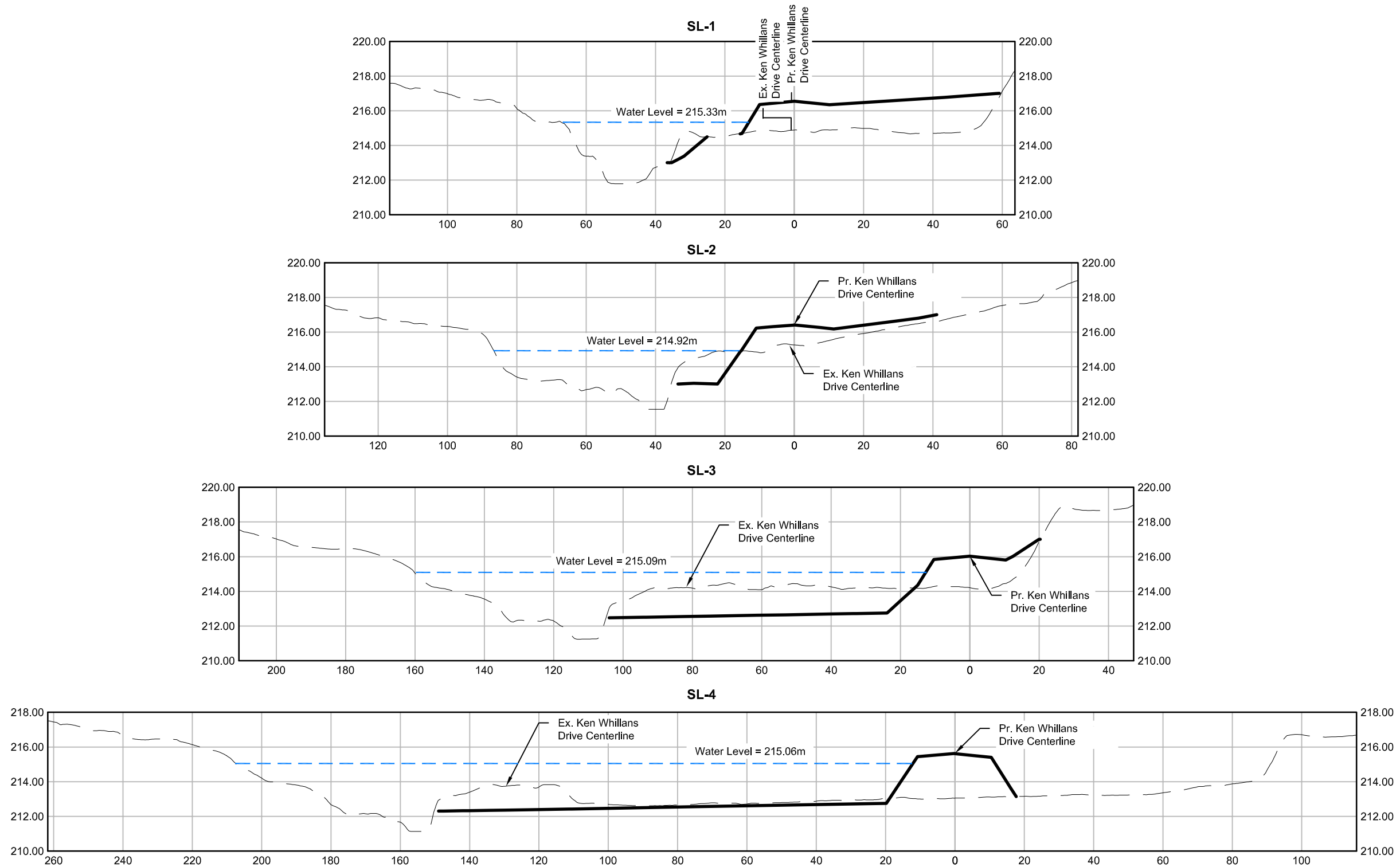

Legend	
	Existing ground
	Proposed Grade

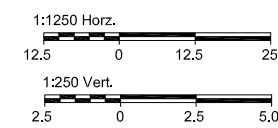

Brampton Floodplain Study

**Upstream Option B:
Re-connected Floodplain
Sections - SL-1 to SL-4**

Date: 08/11/2017 Project: 22062 Technical: Reviewer: Drawn:

Disclaimer: The information contained herein may be compiled from numerous third party materials that are subject to periodic change without prior notification. While every effort has been made by Matrix Solutions Inc. to ensure the accuracy of the information presented at the time of publication, Matrix Solutions Inc. assumes no liability for any errors, omissions, or inaccuracies in the third party material.

Figure H-04

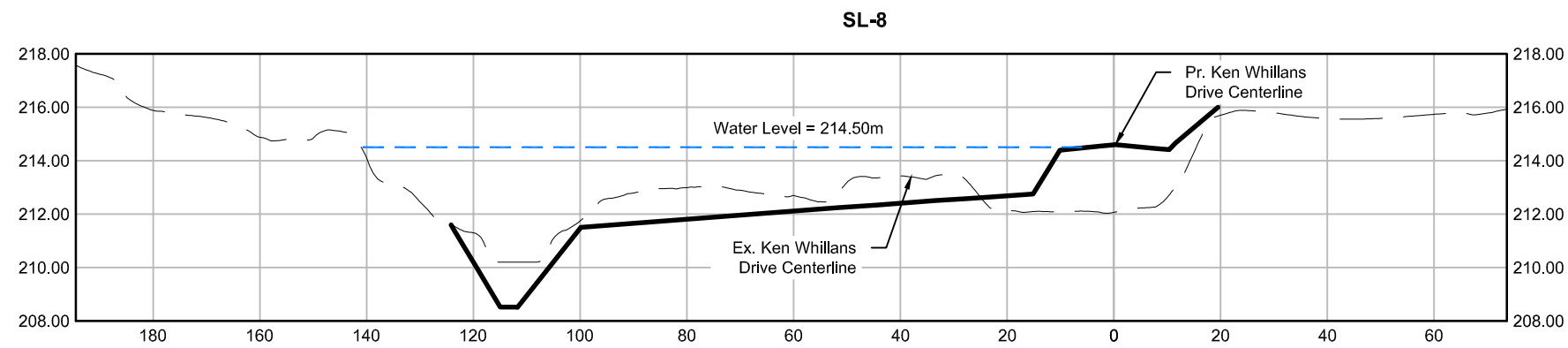
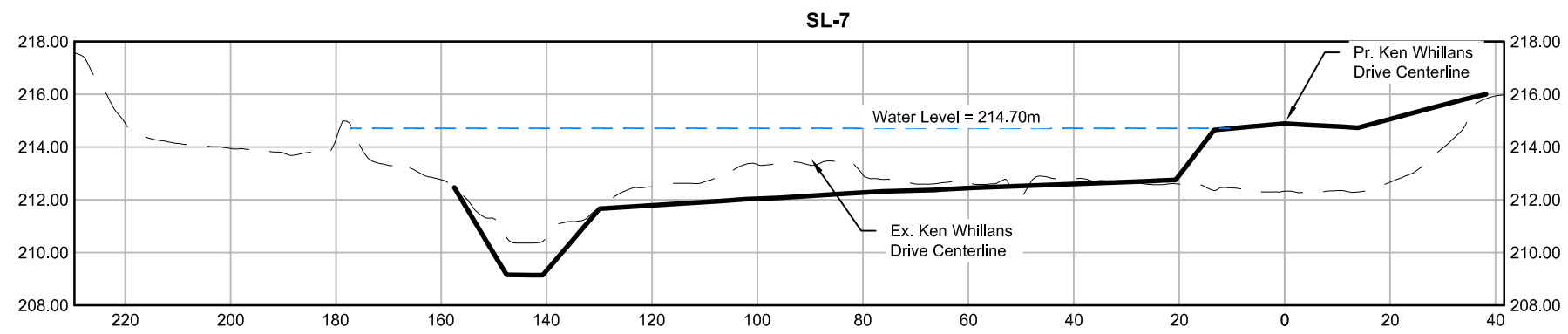
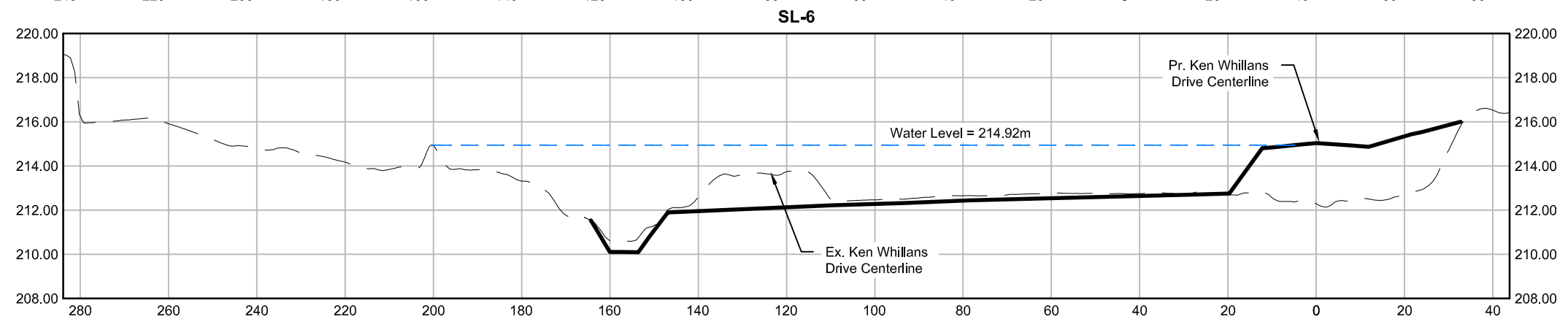
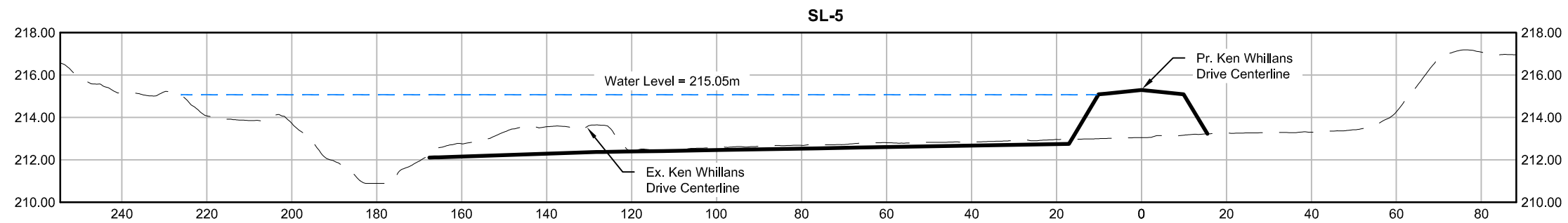

Legend	
	Existing ground
	Proposed Grade

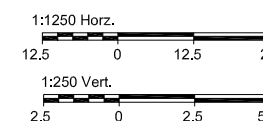

Brampton Floodplain Study

**Upstream Option B:
Re-connected Floodplain
Sections - SL-5 to SL-8**

Date: 08/11/2017	Project: 22062	Technical:	Reviewer:	Drawn:
Disclaimer: The information contained herein may be compiled from numerous third party materials that are subject to periodic change without prior notification. While every effort has been made by Matrix Solutions Inc. to ensure the accuracy of the information presented at the time of publication, Matrix Solutions Inc. assumes no liability for any errors, omissions, or inaccuracies in the third party material.				Figure H-05

N:\PROJECTS\22062 - City of Brampton Flood Study\05 Analysis\CAD\Civil 3D_Shortcuts\Civil 3D\Production Drawings\22062-Slur Grading-06_07_08_10 Jan 2018.dwg - Lgs\Swam Option C_08 - Monday, January 15, 2018 3:22:02 PM - Alexander Mlrszak
 Plot 1:1 = Table(L)

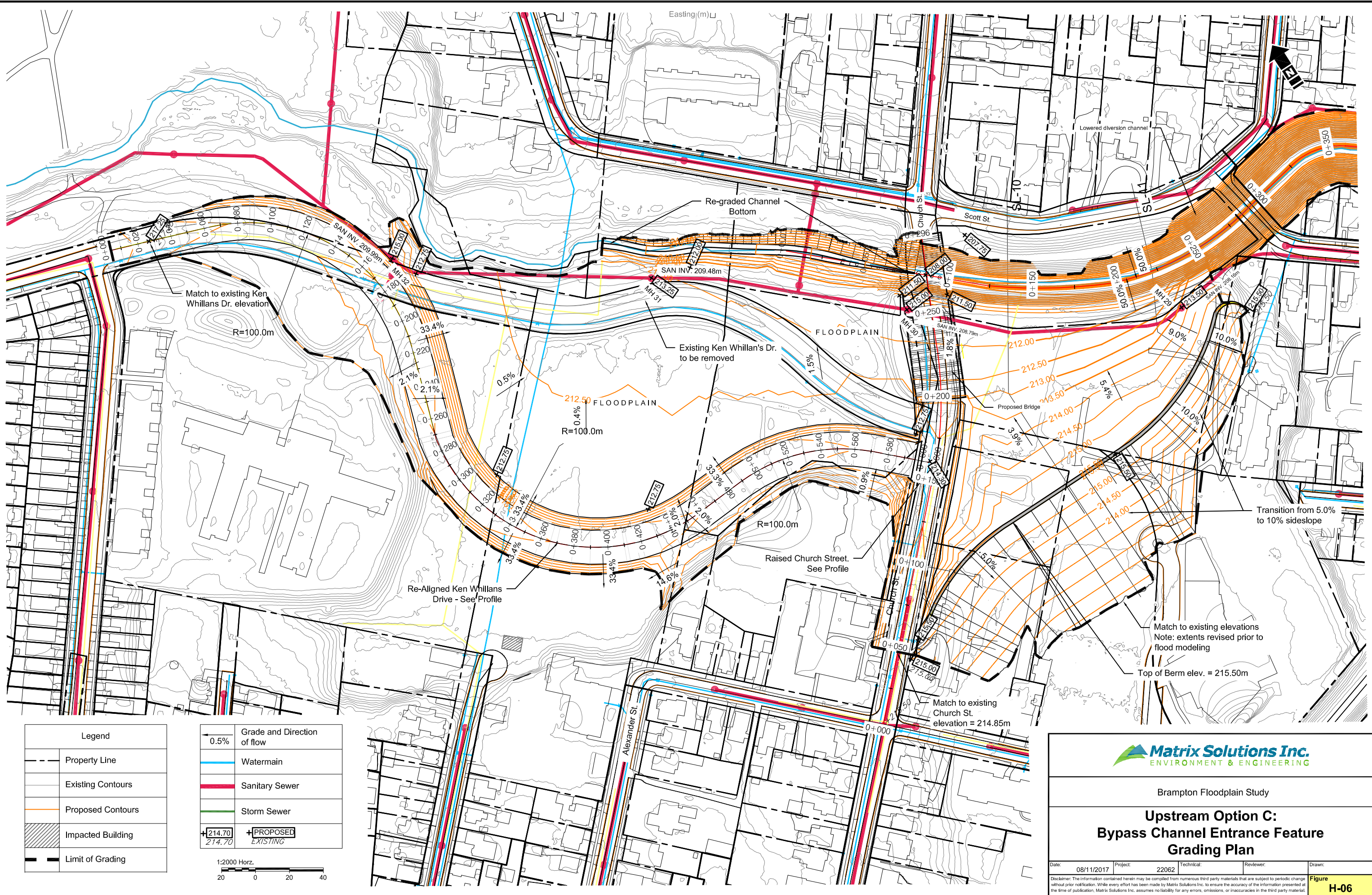

Legend					
	Property Line				
	Existing Contours				
	Proposed Contours				
	Impacted Building				
	Limit of Grading				
	Grade and Direction of flow				
	Watermain				
	Sanitary Sewer				
	Storm Sewer				
	<table border="1"> <tr> <td>+214.70</td> <td>+PROPOSED</td> </tr> <tr> <td>214.70</td> <td>EXISTING</td> </tr> </table>	+214.70	+PROPOSED	214.70	EXISTING
+214.70	+PROPOSED				
214.70	EXISTING				

1:2000 Horiz.

20 0 20 40

Matrix Solutions Inc.
 ENVIRONMENT & ENGINEERING

Brampton Floodplain Study
**Upstream Option C:
 Bypass Channel Entrance Feature
 Grading Plan**

Date: 08/11/2017	Project: 22062	Technical:	Reviewer:	Drawn:
------------------	----------------	------------	-----------	--------

Disclaimer: The information contained herein may be compiled from numerous third party materials that are subject to periodic change without prior notification. While every effort has been made by Matrix Solutions Inc. to ensure the accuracy of the information presented at the time of publication, Matrix Solutions Inc. assumes no liability for any errors, omissions, or inaccuracies in the third party material.

Figure H-06

N:\PROJECTS\22062 - City of Brampton Flood Study\05_Analysis\CAD\Civil\3D_Shortcuts\3D_Production Drawings\22062_Site_Geotech\06_09_10 Jan 2018.dwg - Upstream Option C - Section_07 - Monday, January 15, 2018 3:22:02 PM - Alexander Mizozak

**Cross Sections
SL-10**

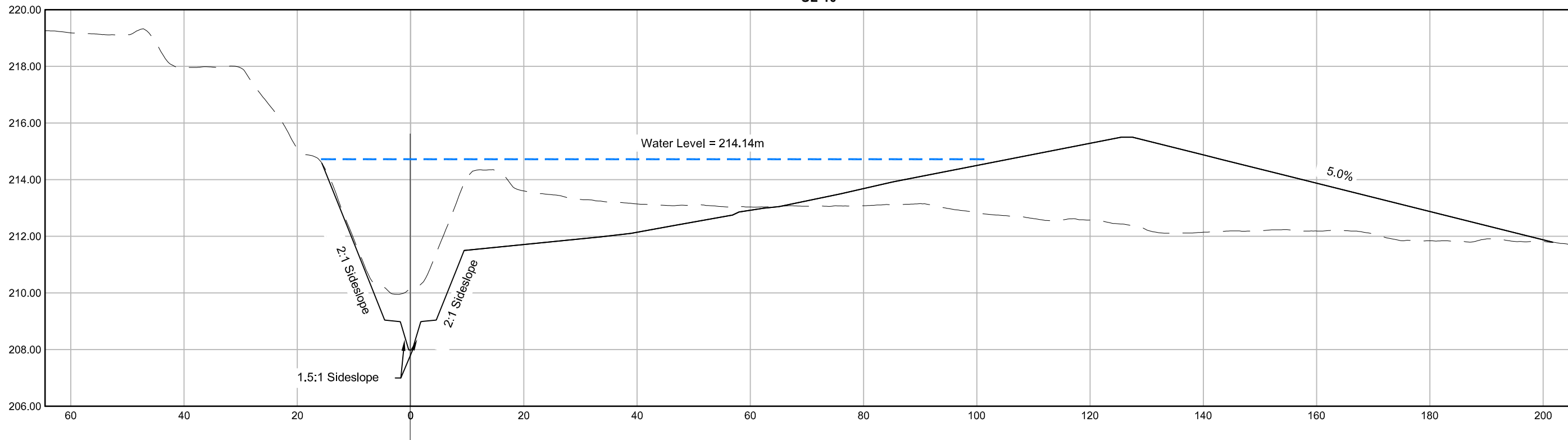

SL-11

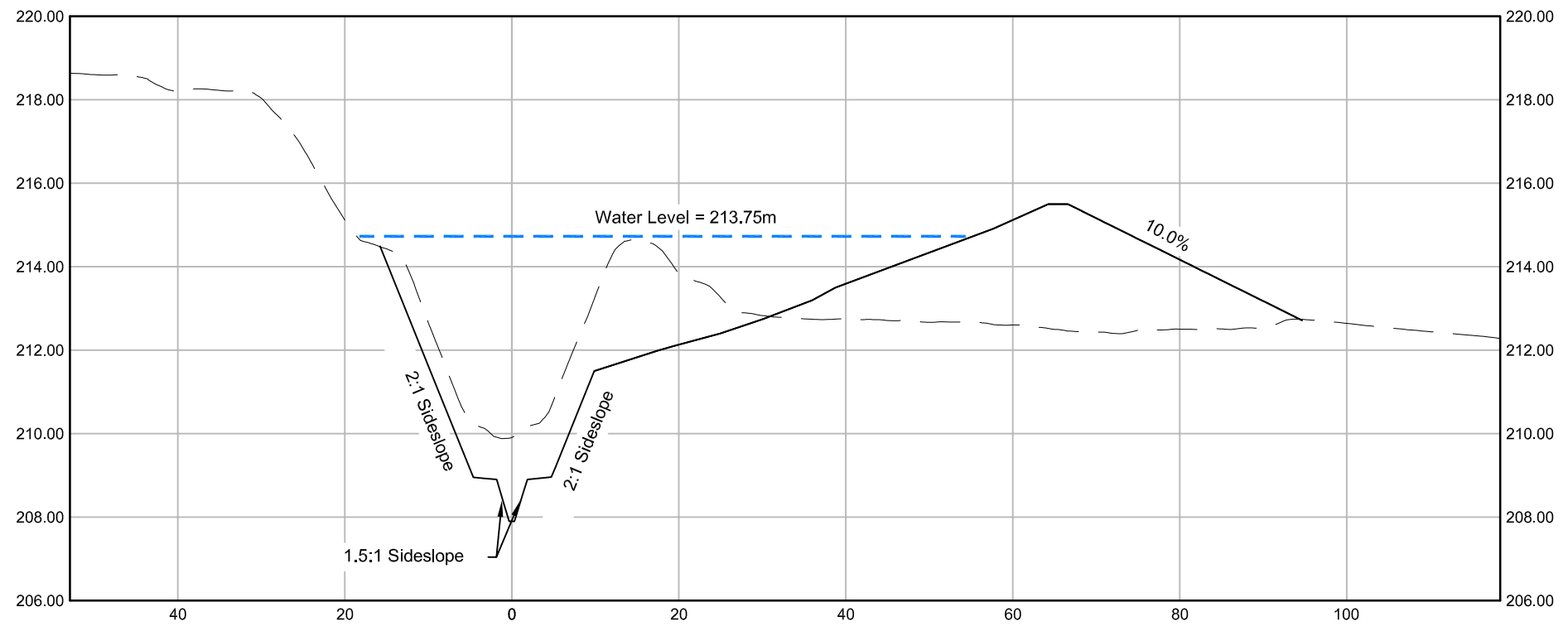

Legend	
	Existing ground
	Proposed Grade

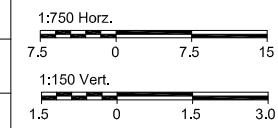

Brampton Floodplain Study

**Bypass Channel Entrance Feature
Sections - SL-10 to SL-11**

Date: 08/11/2017	Project: 22062	Technical:	Reviewer:	Drawn:
<small>Disclaimer: The information contained herein may be compiled from numerous third party materials that are subject to periodic change without prior notification. While every effort has been made by Matrix Solutions Inc. to ensure the accuracy of the information presented at the time of publication, Matrix Solutions Inc. assumes no liability for any errors, omissions, or inaccuracies in the third party material.</small>				
				Figure H-07

N:\PROJECTS\22062 - City of Brampton Flood Study\05_Analysis\CAD\CH1_3D_Sheridan\CH1_3D_Production Drawings\22062-Site_Gradings\05_07_08_09_10_Jan 2018.dwg - Monday, January 15, 2018, 3:59:13 PM - Alexander Miazek
 Plot 11 - Tabloid (L)

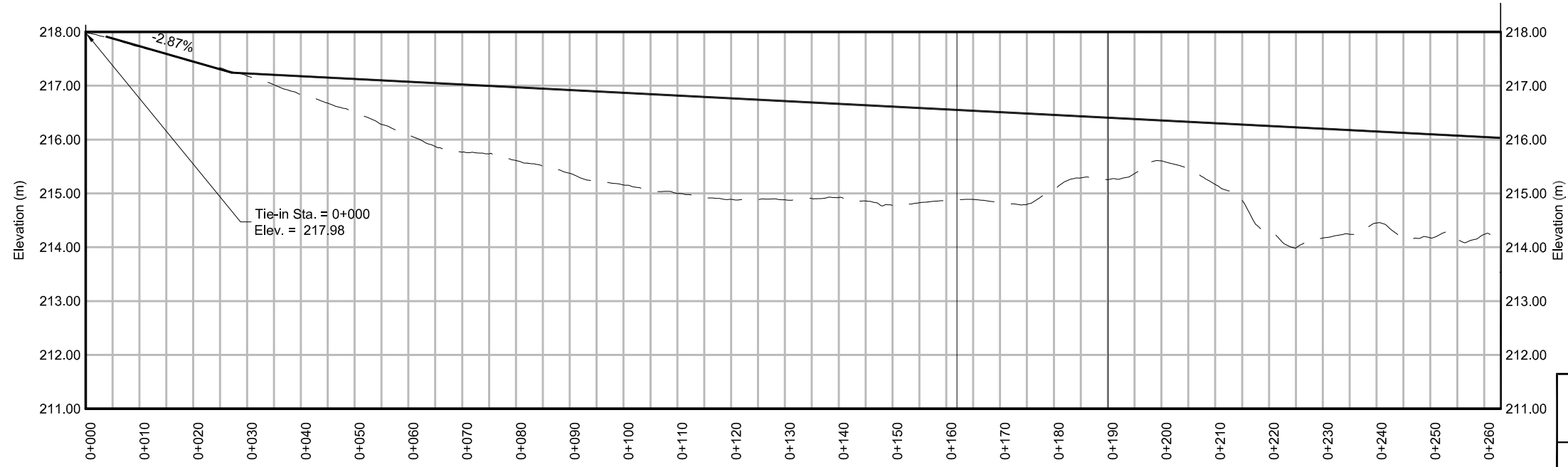
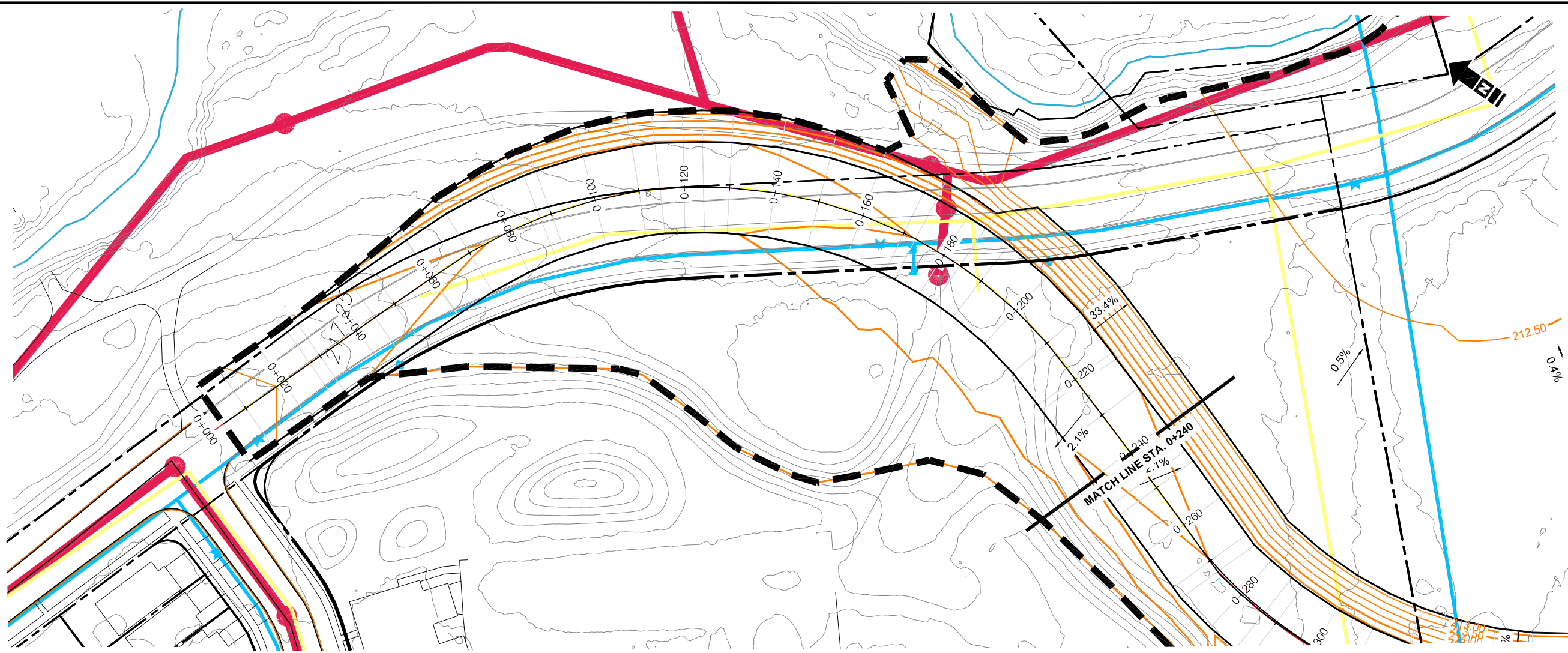

Legend	
	Existing ground
	Proposed Grade

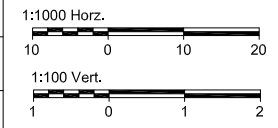



Matrix Solutions Inc.
ENVIRONMENT & ENGINEERING

Brampton Floodplain Study

Ken Whillans
Plan and Profile
Sta. 0+000 - 0+240

Date: 08/11/2017	Project: 22062	Technical:	Reviewer:
Drawn:			

Disclaimer: The information contained herein may be compiled from numerous third party materials that are subject to periodic change without prior notification. While every effort has been made by Matrix Solutions Inc. to ensure the accuracy of the information presented at the time of publication, Matrix Solutions Inc. assumes no liability for any errors, omissions, or inaccuracies in the third party material.

H-08

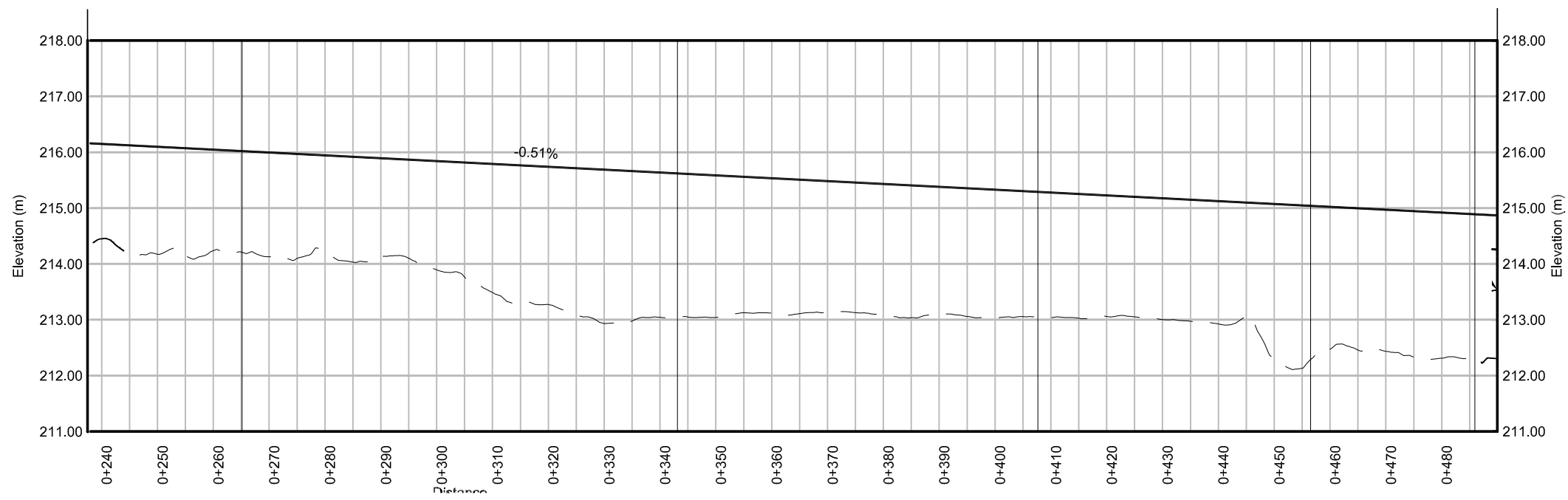
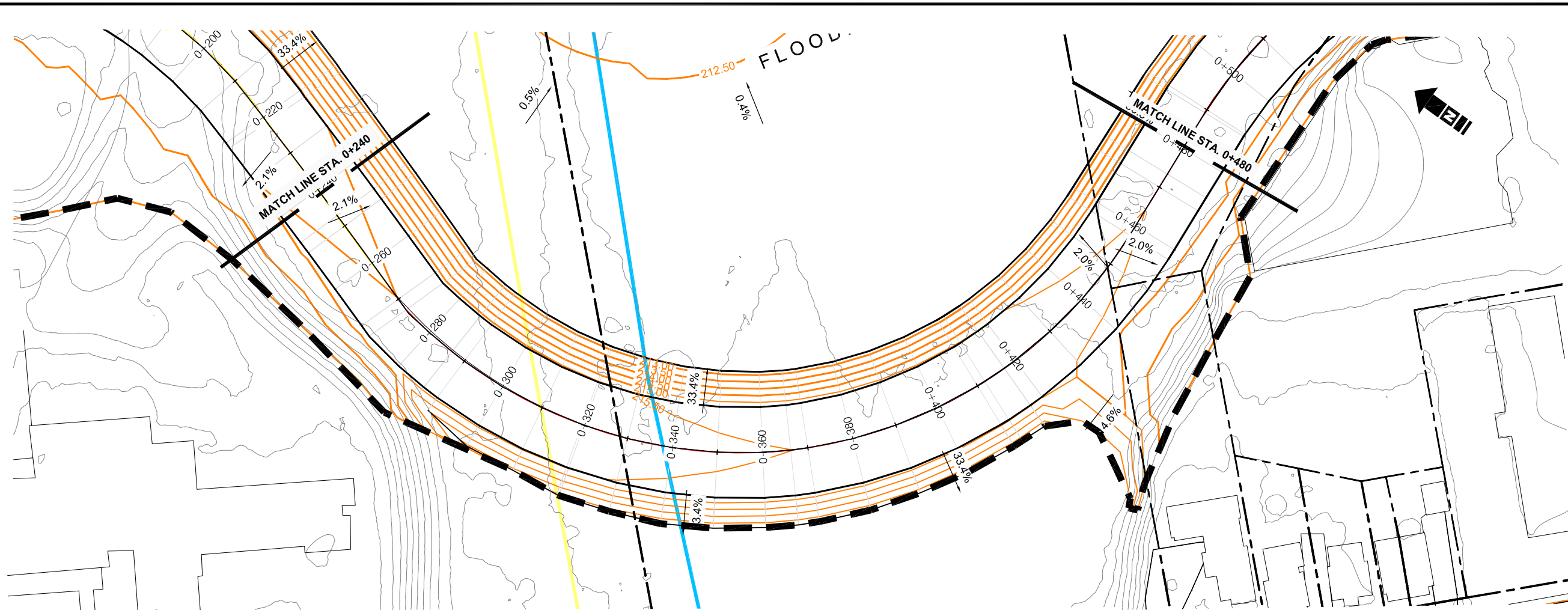

Legend	
	Existing ground
	Proposed Grade

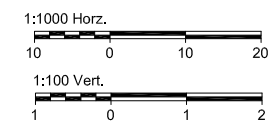

Brampton Floodplain Study

Ken Whillans
Plan and Profile
Sta. 0+240 - 0+480

Date:	08/11/2017	Project:	22062	Technical:		Reviewer:		Drawn:	
-------	------------	----------	-------	------------	--	-----------	--	--------	--

Disclaimer: The information contained herein may be compiled from numerous third party materials that are subject to periodic change without prior notification. While every effort has been made by Matrix Solutions Inc. to ensure the accuracy of the information presented at the time of publication, Matrix Solutions Inc. assumes no liability for any errors, omissions, or inaccuracies in the third party material.

N:\PROJECTS\22062 - City of Brampton Flood Study\05_Analysis\CAD\CH1_3D_Surfaces\C38_3D\Production Drawings\22062-Site_Gradings\05_07_08_09_10_Jan 2018.dwg - Ken Whillans P&P 10 - Monday, January 15, 2018 3:59:13 PM - Alexander Miazoski
 Plot 11 - Table 1 (L)

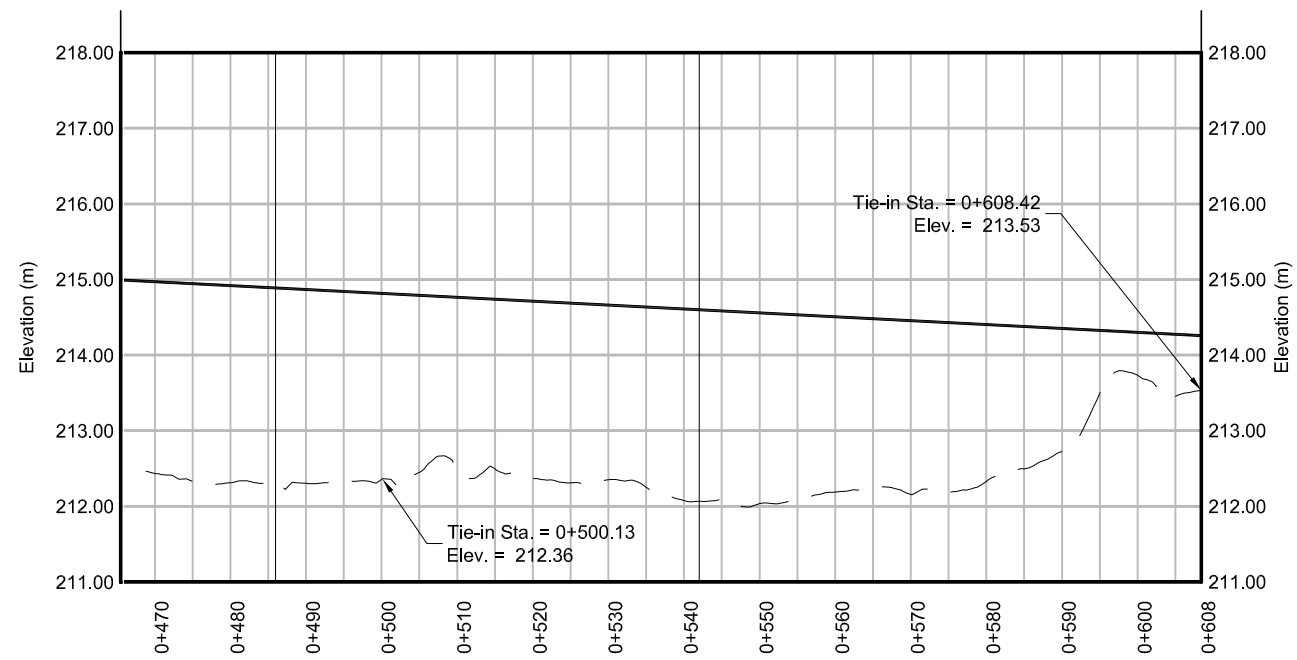
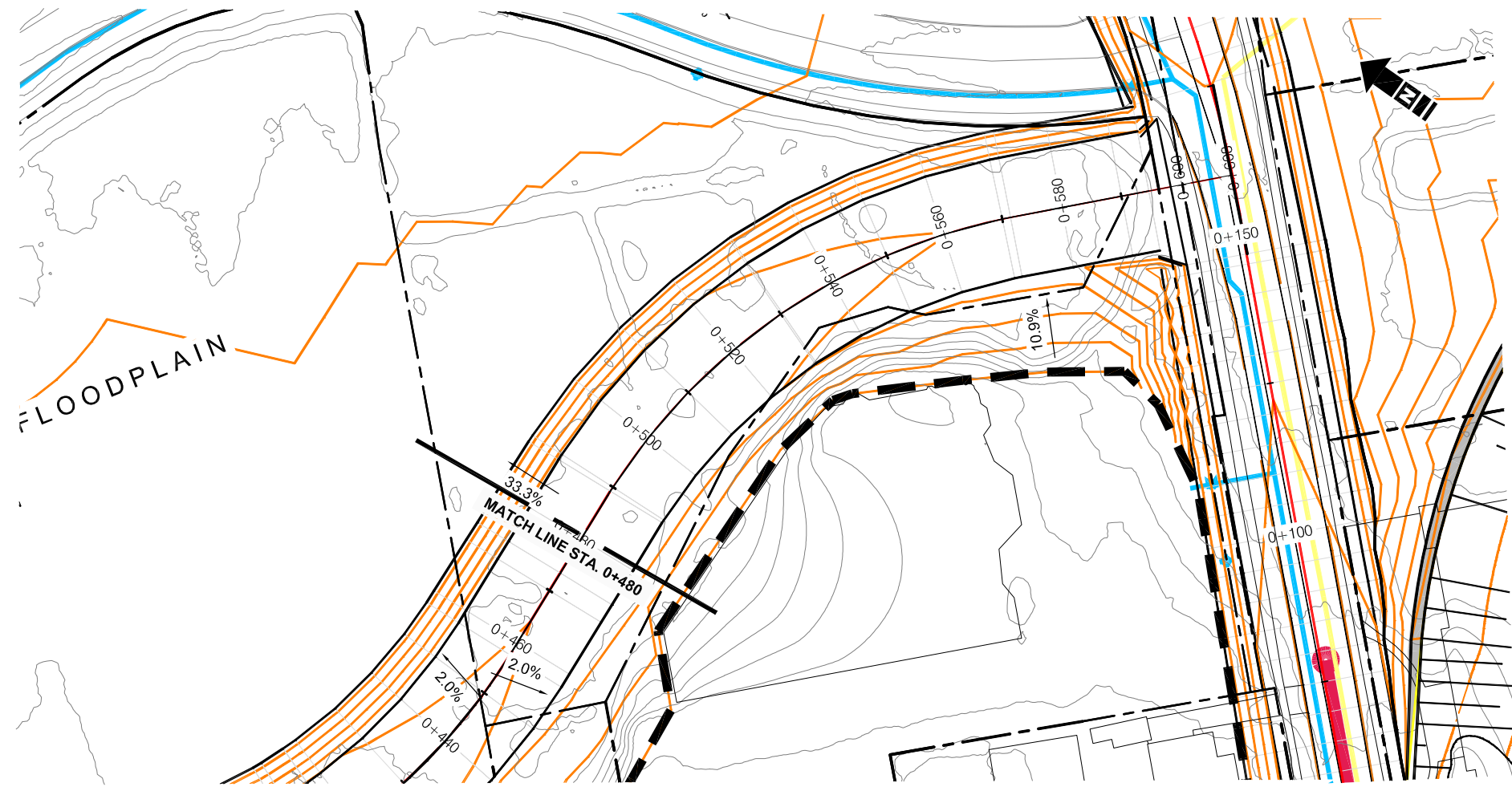

Legend	
	Existing ground
	Proposed Grade

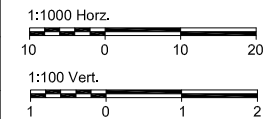

Brampton Floodplain Study			
Ken Whillans			
Plan and Profile			
Sta. 0+480 - 0+608			
Date: 08/11/2017	Project: 22062	Technical:	Reviewer:
Disclaimer: The information contained herein may be compiled from numerous third party materials that are subject to periodic change without prior notification. While every effort has been made by Matrix Solutions Inc. to ensure the accuracy of the information presented at the time of publication, Matrix Solutions Inc. assumes no liability for any errors, omissions, or inaccuracies in the third party material.			Figure H-10

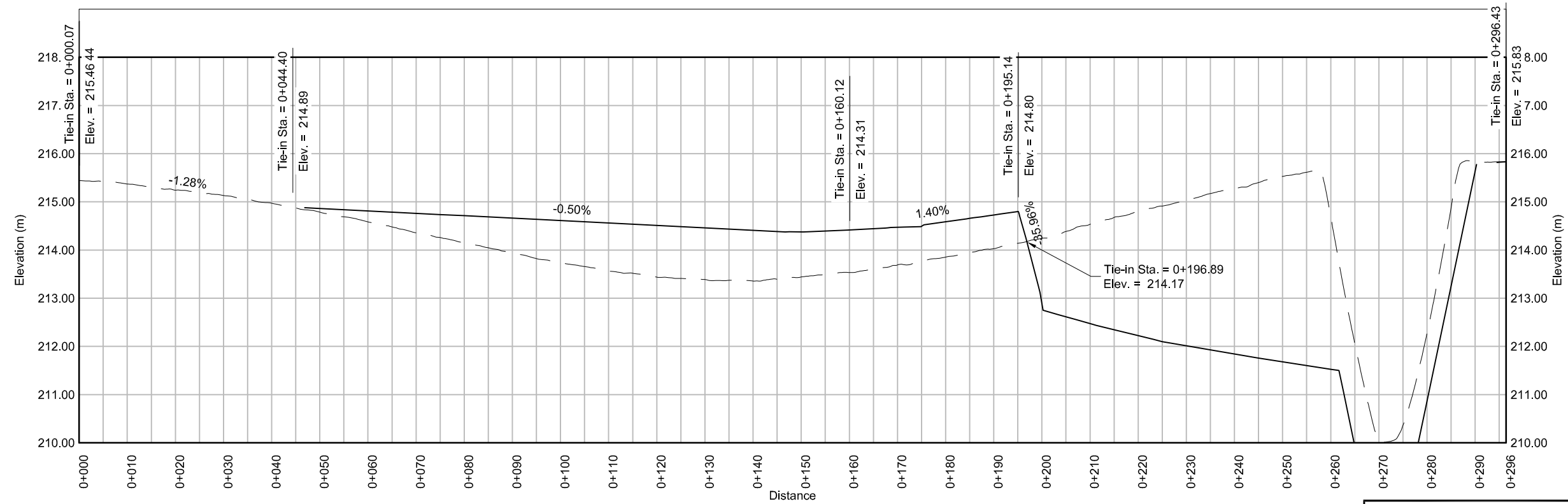
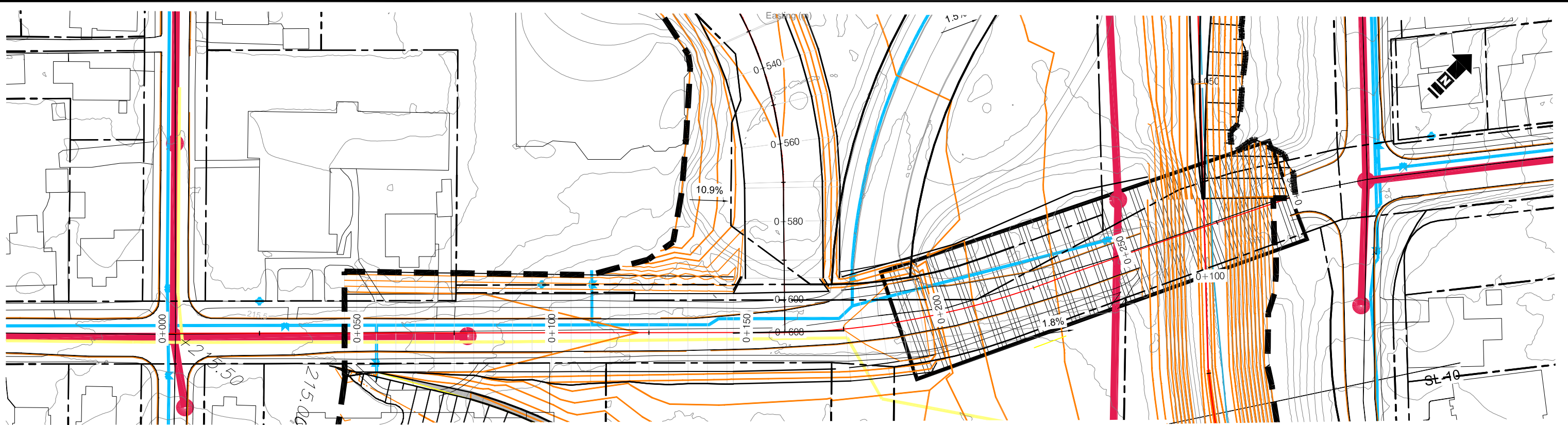

Legend	
	Existing ground
	Proposed Grade

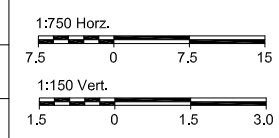

Brampton Floodplain Study

Church Street Plan and Profile Sta. 0+000 - 0+200

Date: 08/11/2017	Project: 22062	Technical:	Reviewer:	Drawn:
------------------	----------------	------------	-----------	--------

Disclaimer: The information contained herein may be compiled from numerous third party materials that are subject to periodic change without prior notification. While every effort has been made by Matrix Solutions Inc. to ensure the accuracy of the information presented at the time of publication, Matrix Solutions Inc. assumes no liability for any errors, omissions, or inaccuracies in the third party material.

N:\PROJECTS\22062 - City of Brampton Flood Study\05_Analysis\CAD\Civil_3D_Shortcut\Civil_3D\Production Drawings\22062-Site Grading\07_08_09_10-Jan-2018.dwg - Downstream Option 1 - 12 - Monday, January 15, 2018 3:22:02 PM - Awanadar Muzczak
 Plot 11 = Tabloid (L)

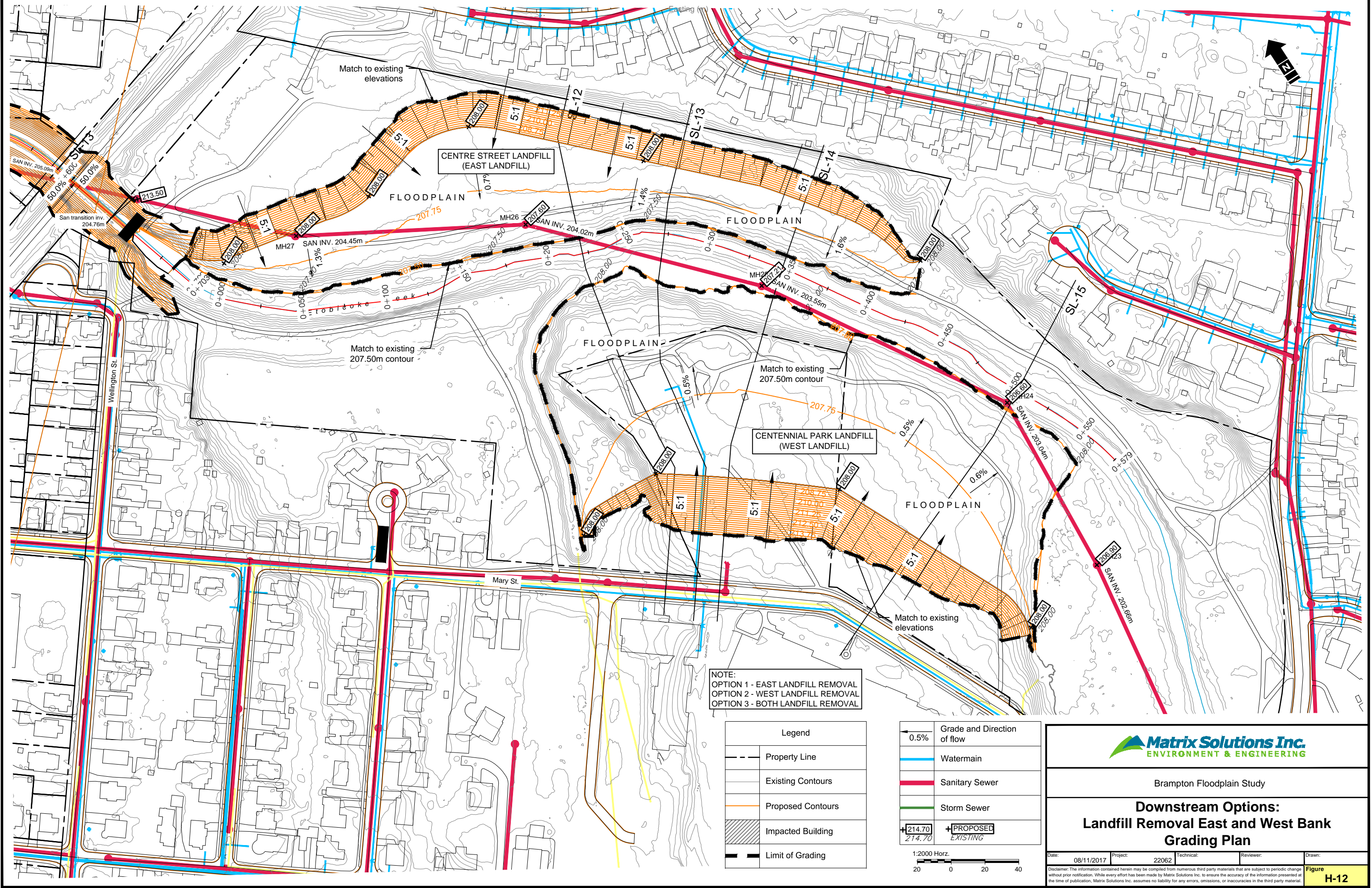

NOTE:
 OPTION 1 - EAST LANDFILL REMOVAL
 OPTION 2 - WEST LANDFILL REMOVAL
 OPTION 3 - BOTH LANDFILL REMOVAL

Legend	
	Property Line
	Existing Contours
	Proposed Contours
	Impacted Building
	Limit of Grading

	Grade and Direction of flow				
	Watermain				
	Sanitary Sewer				
	Storm Sewer				
	<table border="1"> <tr> <td>+214.70</td> <td>+PROPOSED</td> </tr> <tr> <td>214.70</td> <td>EXISTING</td> </tr> </table>	+214.70	+PROPOSED	214.70	EXISTING
+214.70	+PROPOSED				
214.70	EXISTING				
1:2000 Horiz.					

Matrix Solutions Inc.
 ENVIRONMENT & ENGINEERING

Brampton Floodplain Study

**Downstream Options:
 Landfill Removal East and West Bank
 Grading Plan**

Date: 08/11/2017	Project: 22062	Technical:	Reviewer:	Drawn:
------------------	----------------	------------	-----------	--------

Disclaimer: The information contained herein may be compiled from numerous third party materials that are subject to periodic change without prior notification. While every effort has been made by Matrix Solutions Inc. to ensure the accuracy of the information presented at the time of publication, Matrix Solutions Inc. assumes no liability for any errors, omissions, or inaccuracies in the third party material.

Figure H-12

Plot 11 = Tablod (L)
 N:\PROJECT\922082 - City of Brampton Flood Study\05 Analysis\CAD\Civil\3D\Shortcuts\Civil\3D\Production Drawings\2062-Site Grading\06_07_08_10 Jan 2018.dwg - DownStream Option 1-Sectcons_13 - Monday, January 15, 2018 3:22:02 PM - Alexander Miszczak

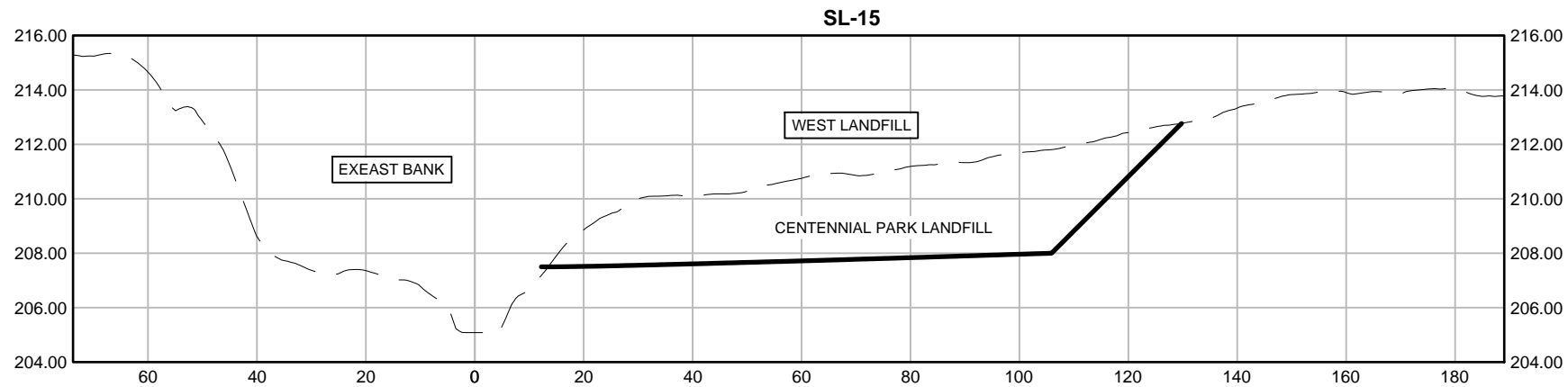
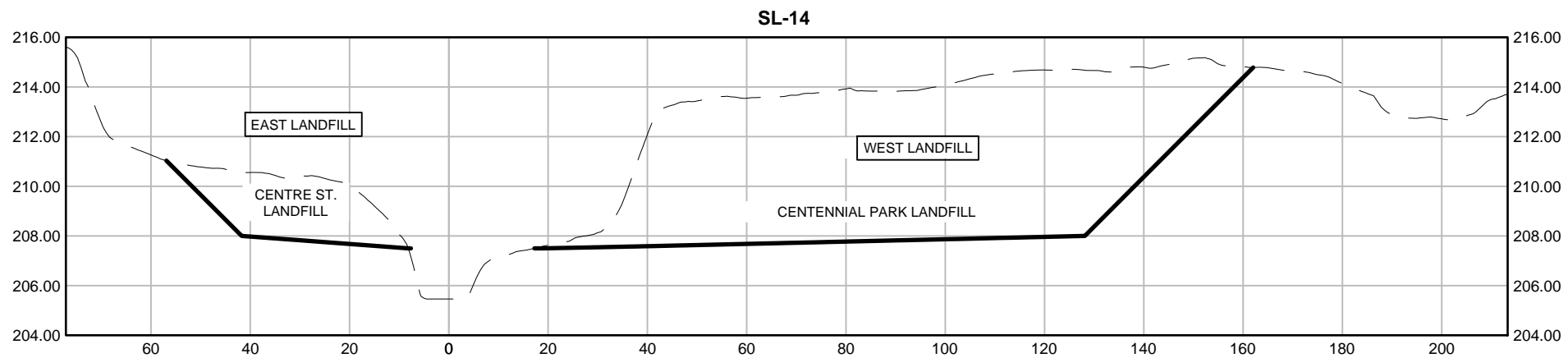
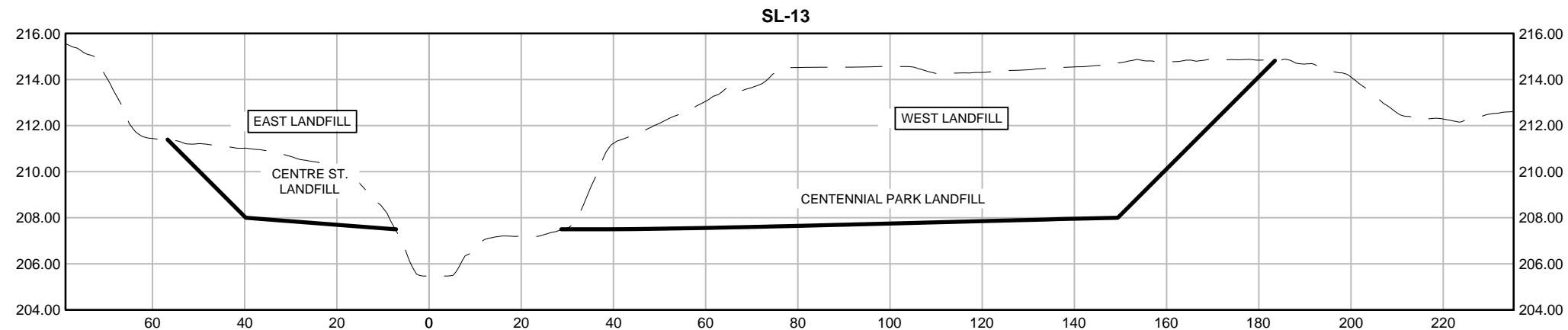
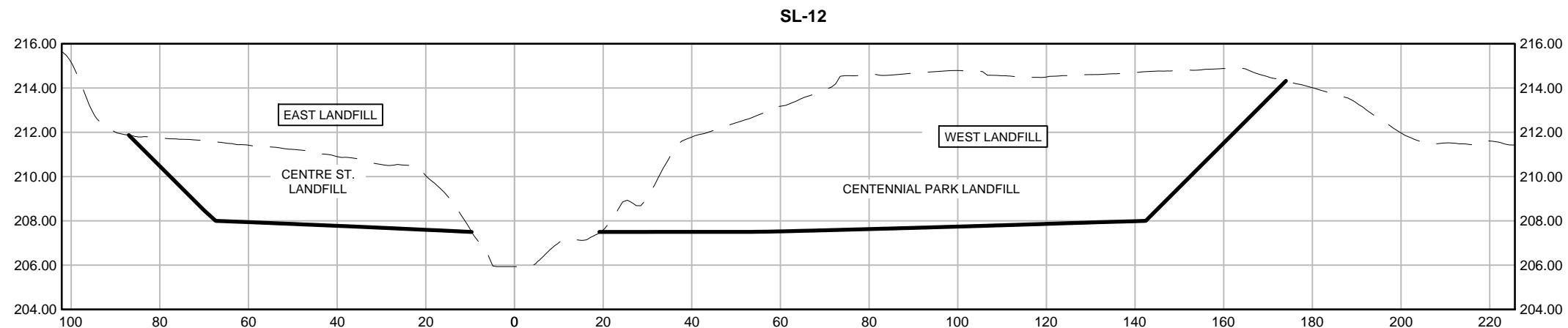

Legend	
	Existing ground
	Proposed Grade



NOTE:
 OPTION 1 - EAST LANDFILL REMOVAL
 OPTION 2 - WEST LANDFILL REMOVAL
 OPTION 3 - BOTH LANDFILL REMOVAL



Brampton Floodplain Study

**Downstream Options:
 Landfill Removal East and West Bank
 Sections - SL-12 to SL-15**

Date: 08/11/2017	Project: 22062	Technical:	Reviewer:	Drawn:
Disclaimer: The information contained herein may be compiled from numerous third party materials that are subject to periodic change without prior notification. While every effort has been made by Matrix Solutions Inc. to ensure the accuracy of the information presented at the time of publication, Matrix Solutions Inc. assumes no liability for any errors, omissions, or inaccuracies in the third party material.				Figure H-13

N:\PROJECTS\22062 - City of Brampton Flood Study\05_Analytical\CAD\3D_Production Drawings\22062-Site Grading\05_07_08_09_10 Jan 2018\05 - Lower Bypass Channel - 14 - Tuesday, January 16, 2018 8:43:55 AM - Alexander Miazek
 Plot 11 - Tabled (1)

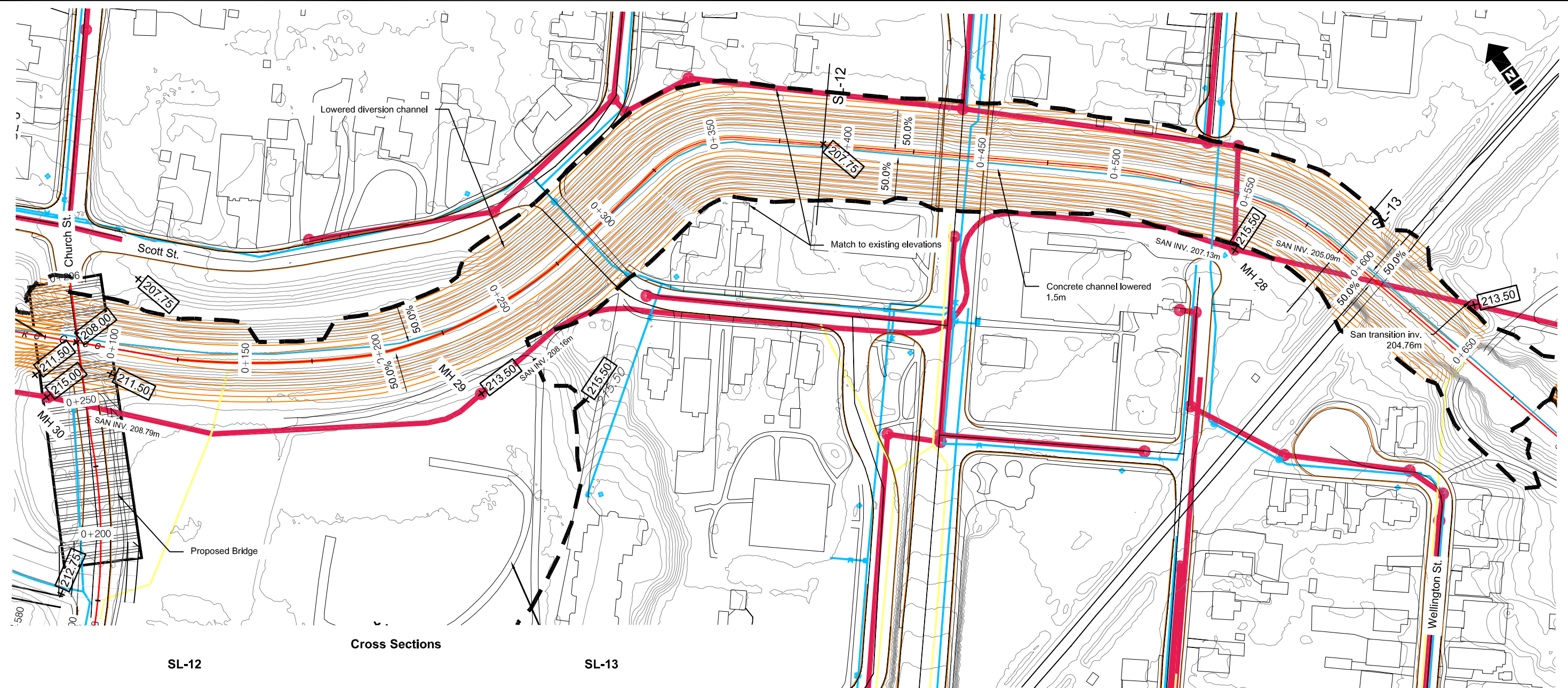

Cross Sections

SL-12

SL-13

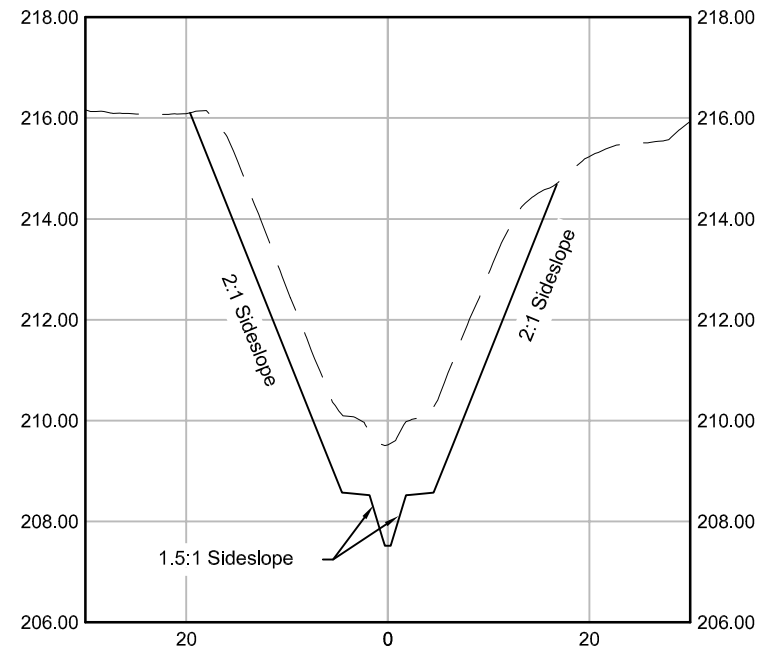
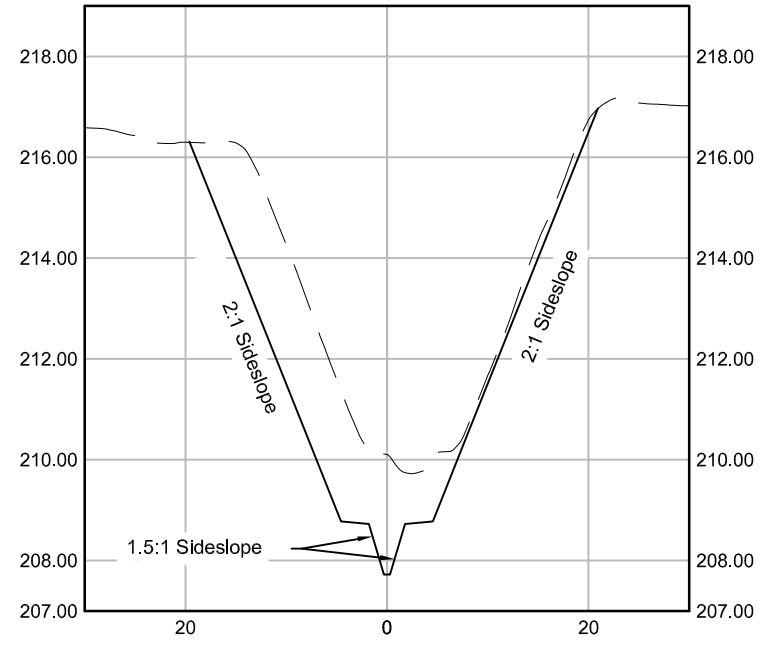

Legend	
	Property Line
	Existing Contours
	Proposed Contours
	Impacted Building
	Limit of Grading
	Grade and Direction of flow
	Watermain
	Sanitary Sewer
	Storm Sewer
	PROPOSED
	EXISTING

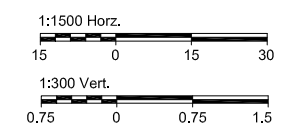

Matrix Solutions Inc.
ENVIRONMENT & ENGINEERING

Brampton Floodplain Study

Lower Bypass Channel Grading and Sections

Date: 08/11/2017	Project: 22062	Technical:	Reviewer:	Drawn:
------------------	----------------	------------	-----------	--------

Disclaimer: The information contained herein may be compiled from numerous third party materials that are subject to periodic change without prior notification. While every effort has been made by Matrix Solutions Inc. to ensure the accuracy of the information presented at the time of publication, Matrix Solutions Inc. assumes no liability for any errors, omissions, or inaccuracies in the third party material.

H-14

APPENDIX I

Capital Cost Estimates

Flood Mitigation Alternative Item		Estimated Quantity	Unit	Unit Price	Cost
Upstream Option A	Cut & Place Fill	29,300	m ³	\$ 15	\$ 439,500
	Import Fill	101,900	m ³	\$ 25	\$ 2,547,500
	Road Works - Ken Whillans Drive (estimate)	150	m	\$ 1,650	\$ 247,500
	Road Works - Church Street (estimate)	130	m	\$ 1,650	\$ 214,500
	1200mm Sanitary Sewer relocation	290	m	\$ 400	\$ 116,000
				Total	\$ 3,565,000
Upstream Option B	Cut & Place Fill	57,000	m ³	\$ 15	\$ 855,000
	Import Fill	5,000	m ³	\$ 25	\$ 125,000
	Road Works - Ken Whillans Drive	590	m	\$ 1,650	\$ 973,500
	Road Works - Church Street	250	m	\$ 1,650	\$ 412,500
	Church Street Bridge Replacement	1	each	\$ 600,000	\$ 600,000
	1200mm Sanitary Sewer relocation	580	m	\$ 400	\$ 232,000
				Total	\$ 3,198,000
Upstream Option C	Cut & Place Fill	71,000	m ³	\$ 15	\$ 1,065,000
	Road Works - Ken Whillans Drive	590	m	\$ 1,650	\$ 973,500
	Road Works - Church Street	250	m	\$ 1,650	\$ 412,500
	Church Street Bridge Replacement	1	each	\$ 1,500,000	\$ 1,500,000
	1200mm Sanitary Sewer relocation	580	m	\$ 400	\$ 232,000
				Total	\$ 4,183,000
Downstream Option 2	Contract Management, equipment, mobilization/demobilization ¹	1	LS	\$ 1,896,150	\$ 1,896,150
	Excavation, transport and disposal of refuse ¹	102,970	m ³	\$ 150	\$ 15,445,500
	Excavation, transport and disposal of fill (soil) ¹	41,920	m ³	\$ 65	\$ 2,724,800
	Excavation and regrading of existing "clean soil" at Centennial Park ¹	39,560	m ³	\$ 20	\$ 791,200
	1200mm Sanitary Sewer relocation	225	m	\$ 400	\$ 90,000
				Total	\$20,947,650
Downstream Option 3	Contract Management, equipment, mobilization/demobilization ¹	1	LS	\$ 3,553,155	\$ 3,553,155
	Excavation, transport and disposal of refuse ¹	205,497	m ³	\$ 150	\$ 30,824,550
	Excavation, transport and disposal of fill (soil) ¹	60,243	m ³	\$ 65	\$ 3,915,795
	Excavation and regrading of existing "clean soil" at Centennial Park ¹	39,560	m ³	\$ 20	\$ 791,200
	1200mm Sanitary Sewer relocation	434	m	\$ 400	\$ 173,600
				Total	\$39,258,300
Riverwalk Option including Removal of Drop Structures in Bypass Channel with Landfill Removal	Channel Reconstruction cost ²	1	LS	\$ 7,140,000	\$ 7,140,000
	Road Works - Ken Whillans Drive	590	m	\$ 1,650	\$ 973,500
	Road Works - Church Street	250	m	\$ 1,650	\$ 412,500
	Church Street Bridge Replacement	1	each	\$ 600,000	\$ 600,000
	1200mm Sanitary Sewer relocation	580	m	\$ 400	\$ 232,000
	Contract Management, equipment, mobilization/demobilization ³	1	LS	\$ 3,553,155	\$ 1,896,150
	Excavation, transport and disposal of refuse ³	205,497	m ³	\$ 150	\$ 15,445,500
	Excavation, transport and disposal of fill (soil) ³	60,243	m ³	\$ 65	\$ 2,724,800
Excavation and regrading of existing "clean soil" at Centennial Park ³	39,560	m ³	\$ 20	\$ 791,200	
				Total	\$30,215,650

¹ Cost estimates associated with landfill removal were obtained from the waste delineation report (WSP 2018)

² Channel reconstruction cost provided by the City (May 2018)

³ Cost estimate assumes only Centennial Park Landfill will be removed