



MAIN STREET SOUTH
HERITAGE CONSERVATION DISTRICT PLAN

JANUARY 2016

ERA

DRAFT

Cover image: 52, 56 and 58 Main Street South, c.1900,
Grand houses set within an open landscape grounds.
(Source: Peel Art Gallery Museum and Archives)

This document is intended to be print on double-sided 8.5x11
colour paper.

CONTENTS

1.0	INTRODUCTION	4
1.1	The District Plan	
1.2	Benefits of Heritage Conservation District Designation	
1.3	Statement of Objectives	
1.4	Statement of Cultural Heritage Value	
1.5	Description of Attributes	
1.6	District Boundary	
1.7	Map of Proposed Heritage Conservation District Boundary	
1.8	Contributing and Non-Contributing Properties	
1.9	List of Contributing Properties	
1.10	Map of Contributing Properties	
2.0	KEY REFERENCE DOCUMENTS	18
2.1	Policy Framework	
2.2	Adjacent Buildings Policy	
2.3	Etobicoke Creek Floodplain Special Policy Area	
3.0	POLICIES & GUIDELINES	21
3.1	District Policy Statements	
3.3	General Principles	
3.4	District Guidelines	
3.2	Architecture	
3.3	Additions	
3.4	New Construction	
3.5	Landscape and Streetscape	
3.6	Lot Severance	
3.7	General Maintenance Guidelines	
3.8	Demolition	
4.0	PROCEDURES	80
4.1	Designation	
4.2	Consistency with Heritage Conservation District Plan	
4.3	Heritage Permit Process	
5.0	BIBLIOGRAPHY	92
6.0	APPENDICES	93
Appendix 1:	Statements of Contribution for Contributing Buildings and Landscapes of Interest	
Appendix 2:	Architectural Style Guide Main Street South Heritage Conservation District	

1.0 INTRODUCTION

1.1 THE DISTRICT PLAN

WHAT IS A HERITAGE CONSERVATION DISTRICT

A Heritage Conservation District is an area identified, or designated, as having significant cultural heritage value.

Designation allows a municipality to adopt a Heritage Conservation District Plan. A district plan is based on the cultural heritage values of the area. The plan ensures the community's heritage conservation objectives and stewardship are respected in making decisions about the future of the area.

CONTEXT OF THE HERITAGE CONSERVATION DISTRICT PLAN

The Main Street South Heritage Conservation District ("the District") follows from the Main Street South Heritage Conservation District Study, which was adopted by Brampton City Council in September 2014.

The Study identified an area along Main Street South, from Wellington Street to Etobicoke Creek, that merits protection as a designated Conservation District under Part V of the Ontario Heritage Act.

The Main Street South Heritage Conservation District Study is available through the City of Brampton.

This District Plan has been developed to provide policies and guidelines for protecting and enhancing of the cultural heritage values of the District. It includes statements about the District's cultural value and aspirations for its future.

THE CONTENT OF THE DISTRICT PLAN

In accordance with Section 41.1(5) of the Ontario Heritage Act, the content of the District Plan includes the following:

- (a) a statement of the objectives to be achieved in designating the area as a heritage conservation district;*
- (b) a statement explaining the cultural heritage value or interest of the heritage conservation district;*
- (c) a description of the heritage attributes of the heritage conservation district and of properties in the District;*
- (d) policy statements, guidelines and procedures for achieving the stated objectives and managing change in the heritage conservation district; and*
- (e) a description of the alterations or classes of alterations that are minor in nature and that the owner of property in the heritage conservation district may carry out or permit to be carried out on any part of the property, other than the interior of any structure or building on the property, without obtaining a permit under Section 42. 2005, c. 6, s. 31.*

SUPPORTING DOCUMENTS

The document should be read together with the Main Street South Heritage Conservation District Study.

Additionally, two supporting documents have been appended to the Plan to further assist in implementing polices and guidelines of the District.

- » *Statements of Contribution for Contributing Buildings and Landscape of Interest.* This provides a profile of each building and site that supports the District's cultural heritage value.
- » *Architectural Style Guide Main Street South HCD.* This provides a summary of various architectural styles found within the District. This document is intended as a guide when discussing appropriate work on buildings within the District.

SCOPE

As per Section 41.1(2) of the Ontario Heritage Act, the District Plan will take precedence in the event of a conflict with existing municipal zoning or other bylaws that were in place before the designation of the District.

1.2 BENEFITS OF HERITAGE CONSERVATION DISTRICT DESIGNATION

There are many benefits to a heritage conservation district designation. The Ontario Heritage Toolkit for Heritage Conservation Districts outlines a list of benefits including:

- » A unique planning framework that respects a community's history and identity;
 - » An enhanced quality of life and sense of place;
 - » Cultural and economic vitality; and,
 - » Healthy cultural tourism.
- » Real estate values in Heritage Conservation Districts generally rise more consistently than surrounding areas¹;
 - » Strong real estate performance and resident satisfaction are most pronounced where district guidelines are enforced¹;
 - » There are issues in many districts such as the possibility for expansion and the need for clearer goals which provide the opportunity for improvements¹; and
 - » Satisfaction with living and owning property in districts is overwhelming².

The Architectural Conservancy of Ontario, completed a two-phase study in 2009 and 2012 that evaluated the outcomes of heritage conservation districts in Ontario, including the Churchville Heritage Conservation District in Brampton. The study included the following key findings:

- » By-and-large the goals set for individual Heritage Conservation Districts have been achieved¹;
- » Satisfaction with living and owning property in districts is overwhelming¹;
- » It is not difficult or time consuming to make appropriate alterations to properties in districts but municipalities should keep better records^{1,2};

Other benefits of a heritage conservation district designation includes the eligibility for financial assistance for conservation work offered by municipal, provincial, and federal agencies if and when they become available, as well as access to specialized value-added urban design services through the City of Brampton that will reinforce the quality of new work in the District.

¹ The Architectural Conservancy of Ontario (2012). Heritage Districts Work! Heritage Conservation District Study Summary Report.

² The Architectural Conservancy of Ontario (2012). Heritage Districts Work – More Stories of Success Heritage Conservation District Study Phase 2 Summary Report. Kayla Jonas Galvin (author).

1.3 STATEMENT OF OBJECTIVES

The District Plan provides guidance to direct future change within the District and assist in the design and decision-making process. The objectives of designating Main Street South as a heritage conservation district are:

PROTECT

- » To conserve the cultural heritage values and attributes of the District as expressed in the District’s Statement of Culture Heritage Value and the District’s Heritage Attributes;
- » To conserve contributing buildings and landscapes and protect them from inappropriate alteration and demolition;
- » To ensure the long-term conservation, enhancement, and management of the grand, park-like landscape character of the District that serves as a green procession into Brampton’s downtown;
- » To conserve established patterns of built form and landscape including building height and massing, setbacks, siting and circulation;

MANGE CHANGE

- » To foster high quality architecture by ensuring new buildings and alterations to existing buildings respect and reinforce the character of the District;
- » To foster high quality landscapes and open spaces by maintaining and enhancing contributing landscapes while ensuring all landscape design is consistent with the District’s Statement of Culture Heritage Value;

- » To encourage the correction of unsympathetic alterations to contributing buildings and landscapes;
- » To permit alterations, new construction and demolition that support the objectives, policies and guidelines of the District Plan;

FEEDBACK

- » To facilitate the appropriate maintenance and restoration through the use of documented evidence, best practices and sound conservation approaches.
- » To ensure by-laws and public works relating to the District are consistent with the District’s Statement of Culture Heritage Value;
- » To periodically review and evaluate the Main Street South Heritage Conservation District Plan’s efficiency, effectiveness, and equity and amend the plan as need be.
- » To foster community support, pride and appreciation of the heritage buildings, landscapes, and character of the District, and promote the conservation of these resources for future generations; and

The policies, guidelines and procedures outlined in the District Plan provide guidance to property owners and residents within the Main Street South Heritage Conservation District, City staff, local councillors and other decision-makers involved in managing change within the District according to the stated objectives.

1.4 STATEMENT OF CULTURAL HERITAGE VALUE

The statement of cultural heritage value for the Main Street South Heritage Conservation District is based on the “Criteria for Determining Heritage Cultural Heritage Value or Interest” as described in Ontario Regulation 9/06 made under the Ontario Heritage Act.

DESCRIPTION

The Main Street South District is a residential neighbourhood directly south of the City of Brampton’s historic and civic downtown core. It consists of properties along Main Street South from south of Wellington Street to the intersection of Main Street South and Etobicoke Creek. The house types and streetscape features of the Main Street South District represent a pattern of development that is distinct from the surrounding area.

The District is characterized by a range of properties, from 19th century estate lots to large 20th century suburban lots. The pattern of development shows an evolution from picturesque ideals of the 19th century estate to a modern suburban form.

DESIGN VALUE

The District includes a rich variety of residential architectural styles from the late 19th century to the 20th century. These include examples of Victorian-era estates in the Italianate and Queen Anne Styles to early-20th century Cape Cod and Craftsmen Bungalow cottages and modern suburban bungalows. The manner in which the houses are situated in relation to vegetation, open

space, and natural land contours gives the architecture added significance. This relationship between landscape and the built form contributes to the intimate and park-like character of the District.

Main Street South is valued for its park-like setting and picturesque qualities with the landscape as a critical predominant feature. Deep, landscaped front yards and curvilinear driveways with landscaped berms contribute to Main Street South as a green procession into the downtown core. Mature trees, shrubs and bushes frame, and in many cases, partially obscure the view of houses within the District. The topographical character of the District reflects the history and influence of Etobicoke Creek.

HOUSES ON MAIN STREET, CIRCA 1900

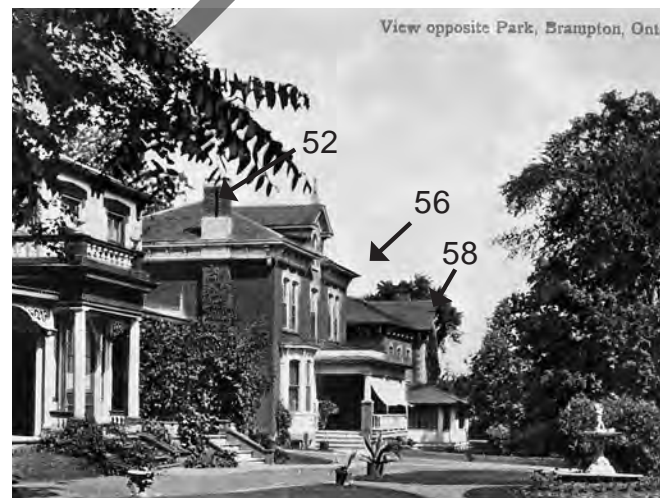

Figure 1. 52, 56 and 58 Main Street South, c.1900, Grand houses set within an open landscape grounds. (Source: Peel Art Gallery Museum and Archives)

HISTORICAL VALUE

The District has historical value as one of the oldest residential neighbourhoods in the city. The District features large houses associated with historically prominent Brampton residents, including John Elliott, one of the city's founding fathers, as well as civic leaders such as Kenneth Chisholm and William Perkins Bull. As Brampton emerged as the County seat of Peel and a thriving community by mid-1860s, Main Street South became the preferred place of residence for Brampton's political and business elite who wished to reside near the civic, commercial, and institutional core of community.

Main Street South, as part of Hurontario Street, is associated with a historic overland connection between Lake Ontario and Lake Huron first surveyed in 1818. This route served as the control line for an 1819 survey which established six concession roads on either side. The change in lot patterns along Main Street South reflect Brampton's emergence as the County seat of Peel and subsequent growth into a thriving city.

The District includes significant features that demonstrate the close historic relationship between the community building and landscape. It includes remnants of retaining walls and bridge posts from the original course of Etobicoke Creek, prior to its diversion in 1952. The historic patterns of property subdivision in the District also reflect the original course of the creek.

ALDERLEA ESTATE IN 1877



Figure 2. William J. Gage's Alderlea Estate. The front gardens were donate to become Gage Park, Brampton's first public park. (Source: 1877 Walkers & Miles Atlas)

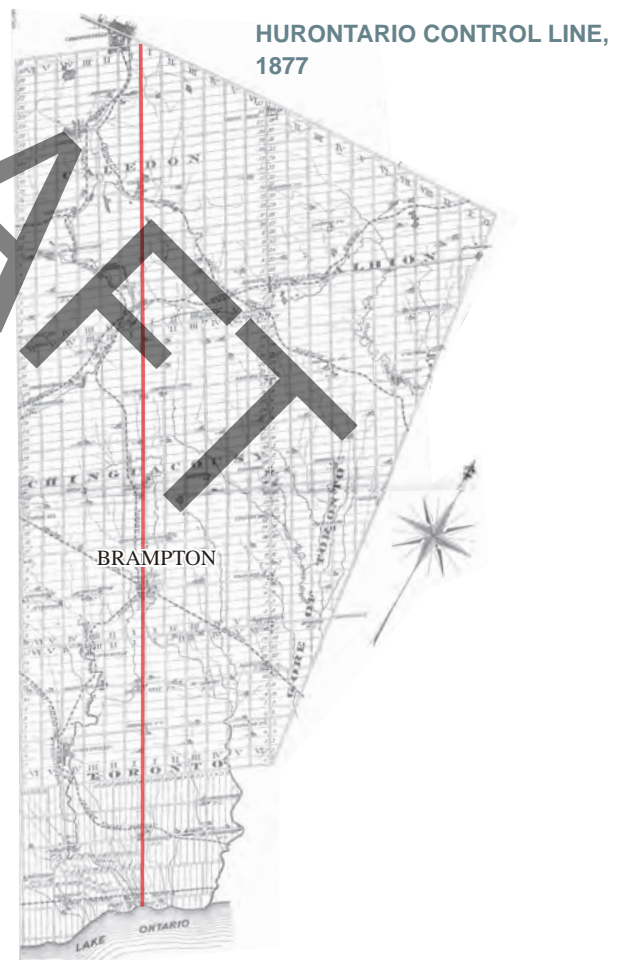

Figure 3. 1877 Walker & Miles map of the County of Peel with Hurontario control line highlighted in red. (Source: 1877 Walkers & Miles Atlas)

Brampton's first municipal park, Gage Park, at north-west end of the District, was once the front gardens of the Alderlea Estate. Opened in 1903, Gage Park was made possible by donated lands from prominent Brampton resident, Sir William J. Gage, and the dedication of Brampton citizens who championed the need for a public park.

CONTEXTUAL VALUE

The District is an important area where the City's built, cultural, and natural heritage overlap. Defined by a sequence of mature trees with deep landscaped lots of the homes that line the street, the District as a whole functions as a green procession into Brampton's historic and civic downtown core. It terminates with the Peel Art Gallery, Museum & Archives, (formerly the Peel Heritage Complex) on the east side of the corridor and City Hall on the west.

Many fine specimens of mature native tree species, particularly sugar maples, are found within the districts. In the District, trees frame the street and are a significant proportion of the downtown tree canopy. Trees in the District provide an important natural link to the Brampton's open space and natural heritage system.

The combination of these contributing elements and their respective cultural heritage value make Main Street South a unique and culturally significant area worthy of recognition and protection.

NATURAL HERITAGE CONTEXT



Figure 4. Foot bridge on Main Street South, opposite Gage Park, before Etobioke Creek was diverted. (Source: City of Brampton)

1.5 DESCRIPTION OF ATTRIBUTES

Heritage attributes are the individual qualities of an area that express or embody its heritage value. Attributes of the Main Street South neighbourhood, as a significant cultural heritage landscape, include:

- » Fine examples of residential architecture from several periods of construction;
- » One-and-a-half to two-and-a-half storey height of dwellings;
- » The park-like setting of the District established by generous side yards, deep lot depths, and large setbacks that lengthen approaching Gage Park;
- » Landscaped front yards and curvilinear driveways with landscaped berms that contribute to Main Street South as a green procession into the downtown core;
- » Remnants of the retaining walls and bridge posts at 52-58 Main Street South that illustrate the evolution of Etobicoke Creek;
- » Early residences of some of Brampton's most prominent residents, such as John Elliot, Kenneth Chisholm, William Perkins Bull;
- » Gage Park as Brampton's first municipal park and its association with Sir William J. Gage;
- » Estate laneways that connect Main Street South and Elizabeth Street;
- » Historic coach houses;
- » Picturesque views and vistas presented along the corridor;
- » Gateway function into downtown Brampton, or "Old Brampton";
- » Mature native vegetation, sugar maples in particular, that constitute an important contribution to the city's overall urban tree canopy and distinguishes the area from surrounding neighbourhoods;
- » The landform and topography of the area as shaped by the historic Etobicoke Creek course;
- » The topography reflecting the alignment of the Etobicoke Creek prior to its diversion, especially the valley slope and top of bank for Etobicoke Creek.



Images:

Figure 5. The northern terminus of the District at Wellington Street is articulated by some of Brampton's most important civic and historic landmarks, including City Hall. (Source: ERA)

Figure 6. Grading and large setbacks reflect the evolution of Etobicoke Creek and its impact on the District. (Source: ERA)

Figure 7. Gage Park is Brampton's first municipal park, which opened in 1903. (Source: ERA)

Figure 8. Finely designed homes are found in the District. 133 Main Street South is regarded as a good example of the Gothic Revival style in Brampton. (Source: ERA)

Figure 9. 108 Main Street illustrates the sophistication and refinement of architectural design found within the District. (Source: ERA)

Figure 10. Fine architecture built on the former estate of John Elliott, a founding citizen of Brampton. (Source: ERA)

1.6 DISTRICT BOUNDARY

The Main Street South Heritage Conservation District consists of all properties that front onto Main Street South, between Wellington Street and the intersection of the Etobicoke Creek and Main Street.

The Peel County Courthouse and Registry Office are significant heritage landmarks that front onto Main Street South. However, the 2009 Downtown Heritage Conservation District Feasibility Study found they contribute to an abutting potential heritage conservation district associated with the civic, religious and commercial heart of old Brampton. For this reason, these two buildings have not been included in the Main Street South District.

St. Mary's Church at 66A Main Street South is included within the District boundary and is closely associated with the history and evolution of the District. However, as the only institutional property within a residential district, the guidelines are better suited to portions of the property that are visible from Main Street South. Applications regarding this property will thus be evaluated on a case-by-case basis.

1.7 MAP OF PROPOSED HERITAGE CONSERVATION DISTRICT BOUNDARY

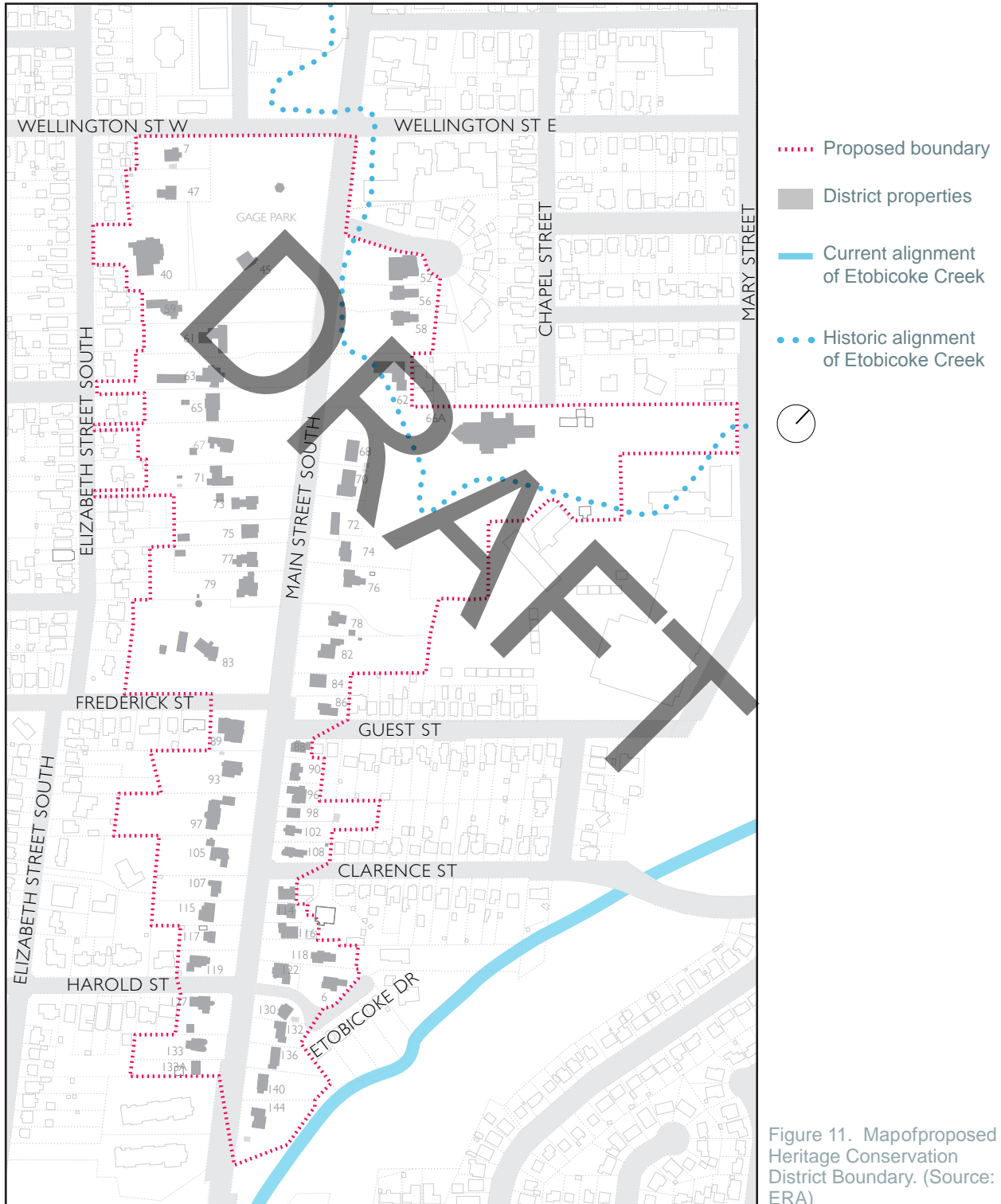

Figure 11. Map of proposed Heritage Conservation District Boundary. (Source: ERA)

1.8 CONTRIBUTING AND NON-CONTRIBUTING PROPERTIES

As a whole, the District forms one of Brampton's most important cultural heritage landscapes. All properties within the Heritage Conservation District are designated under Part V of the Ontario Heritage Act.

A selection of the properties in the District have been further identified as Contributing Properties. As well, many properties are also identified as Landscapes of Interest, due to the importance of their contribution to the overall landscape character of the District.

Contributing Properties and Landscapes of Interest are listed in the table in Subsection 1.9 and are identified on the map in Subsection 1.10 on the following pages.

CONTRIBUTING PROPERTIES

A contributing property includes a structure, landscape, or other attribute that supports the identified cultural heritage values, character, and/or integrity of the Heritage Conservation District. Properties have been categorized according to how they contribute to the heritage value and character of Main Street South, including contributing buildings, landscapes of interest, or both.

While most properties contribute due to both their buildings and landscape features, 13 are notable for landscape or buildings alone. Contributing buildings are structures that enhance the heritage value of the District and should be conserved with careful consideration. Conservation work, alterations and additions should be undertaken with the assistance of qualified heritage professionals. To

help determine when a heritage professional is needed, contact heritage staff at the City of Brampton for guidance and assistance.

LANDSCAPES OF INTEREST

Among the District's Contributing Properties are landscape features that support the District as a cultural heritage landscape in regard to:

- » the tree canopy;
- » natural topography and historic contours of the Etobicoke Creek;
- » large, landscaped, setbacks from the street;
- » rear laneways and irregular driveways that follow picturesque-like patterns;
- » remains of the Etobicoke Creek retaining wall in front of 56-58 Main Street S; and
- » lawn terracing along several properties.

If a property contains one or more of these elements, it is considered a landscape of interest.

PROPERTIES DESIGNATED OR LISTED PRIOR TO THE HERITAGE CONSERVATION DISTRICT

All properties that were listed on the City of Brampton heritage register or designated under the Ontario Heritage Act prior to the Heritage Conservation District Study have been identified as Contributing Properties. As the character of the study area continues to evolve these assessments should be reviewed on a regular basis to ensure that an accurate representation of their contributing qualities is maintained.

1.9 LIST OF CONTRIBUTING PROPERTIES

West Side	Contributing Building	Landscape of Interest	East Side	Contributing Building	Landscape of Interest
7 Wellington St.	✓	✓	52 Main St S	✓	✓
45 Main St S	✗	✓	56 Main St S	✓	✓
47 Main St S	✓	✓	58 Main St S	✓	✓
40 Elizabeth St	✓	✓	62 Main St S	✗	✓
59 Main St S	✓	✓	66A Main St S	✓	✗
61 Main St S	✓	✓	68 Main St S	✓	✓
63 Main St S	✓	✓	70 Main St S	✗	✓
65 Main St S	✗	✓	72 Main St S	✓	✓
67 Main St S	✓	✓	74 Main St S	✗	✓
71 Main St S	✗	✓	76 Main St S	✓	✓
73 Main St S	✓	✓	78 Main St S	✓	✓
75 Main St S	✓	✓	82 Main St S	✓	✓
77 Main St S	✓	✓	84 Main St S	✓	✓
79 Main St S	✓	✓	86 Main St S	✓	✓
83 Main St S	✓	✓	88 Main St S	Not Contributing	
89 Main St S	Not Contributing		90 Main St S	Not Contributing	
93 Main St S	✓	✓	96 Main St S	✓	✗
97 Main St S	✗	✓	98 Main St S	✗	✓
105 Main St S	✓	✓	102 Main St S	✓	✓
107 Main St S	✓	✓	108 Main St S	✓	✓
115 Main St S	✗	✓	13 Clarence St	Not Contributing	
117 Main St S	✓	✓	114 Main St S	✓	✓
119 Main St S	✓	✓	116 Main St S	Not Contributing	
127 Main St S	✓	✓	118 Main St S	✓	✓
133 Main St S	✓	✓	6 Etobicoke Dr	✓	✓
133A Main St S	Not Contributing		122 Main St S	Not Contributing	
			130 Main St S	Not Contributing	
			132 Main St S	✗	✓
			136 Main St S	✗	✓
			140 Main St S	✓	✓
			144 Main St S	✓	✓

1.10 MAP OF CONTRIBUTING PROPERTIES

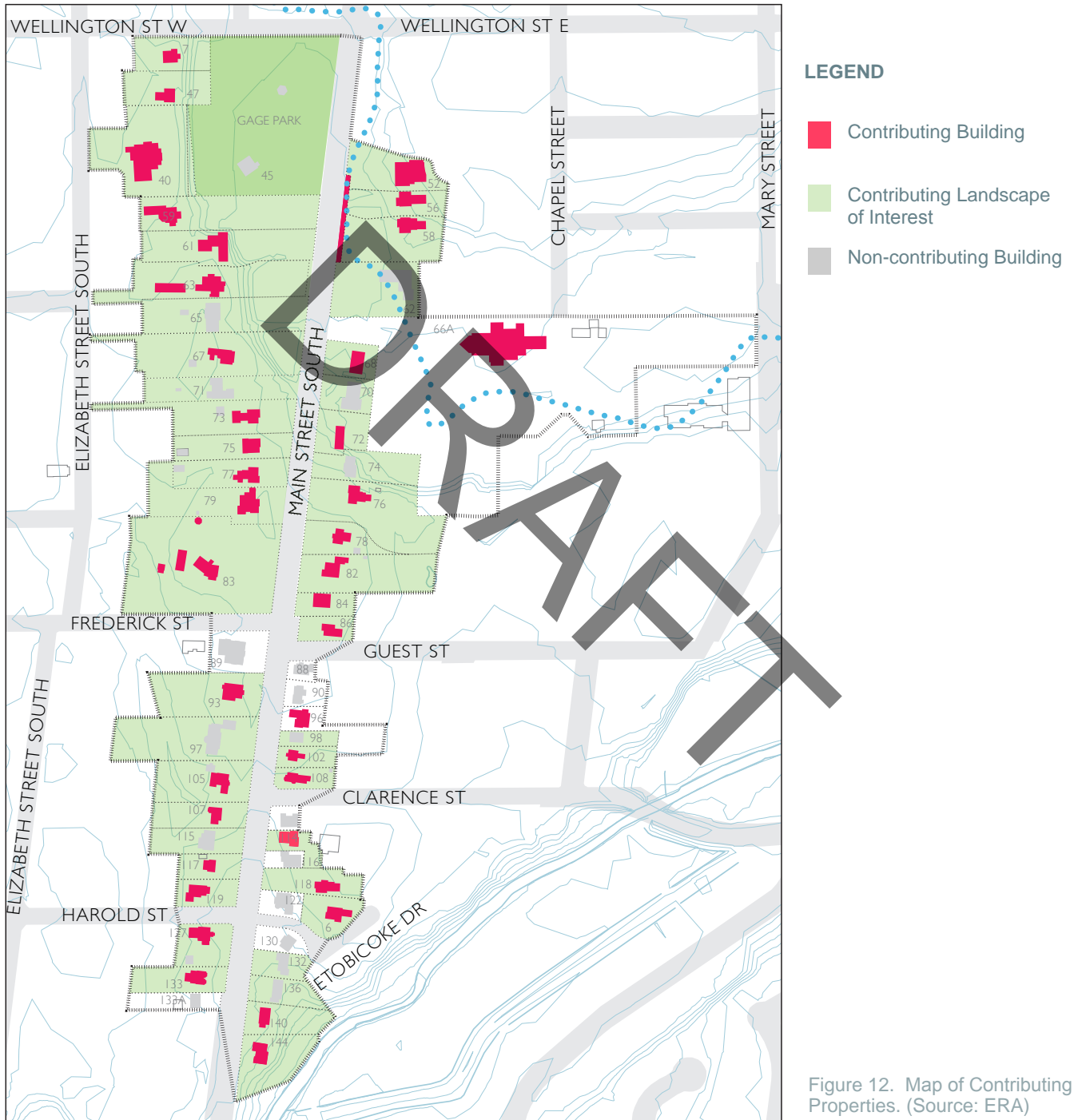

2.0 KEY REFERENCE DOCUMENTS

2.1 POLICY FRAMEWORK

The City of Brampton's current policy framework is generally consistent with the intent of the District Plan.

Brampton's Official Plan, the Downtown Brampton District Secondary Plan and municipal zoning by-laws for Main Street South support the District's character as related to matters such as minimum front yard setbacks, side yard requirements, lot coverage, subdivision of lots, and tree preservation.

For existing planning and zoning controls see:

- » Downtown Brampton District Secondary Plan, Special Policy Area Number 1
- » City of Brampton Zoning By-Law 270-2004
- » Tree Preservation By-Law 38-2006

These documents are intended to be used in tandem with the Main Street South Heritage Conservation District Plan. Any future changes to the Official Plan, Downtown Brampton Secondary Plan, Zoning By-Law and Tree Preservation By-Law should be aligned with, and reflect the objectives and guidelines set out in the Main Street South Heritage Conservation District Plan.

Additional reference materials for best practices in heritage conservation include:

- » *Standards and Guidelines for the Conservation of Historic Places in Canada by Parks Canada*
- » *Eight Guiding Principles in the Conservation of Built Heritage Properties by the Ministry of Culture*
- » *Preservation Briefs by the US Department of the Interior National Park Service*
- » *Well-Preserved: The Ontario Heritage Foundation's Manual of Principles and Practice for Architectural Conservation by Mark Fram.*
- » *A Guide to Canadian Architectural Styles, Second Edition by Shannon Ricketts, Leslie Maitland and Jacqueline Hucker.*
- » *Ontario Architecture: A Guide to Styles and Building Terms, 1784 to the Present by John J.G Blumenson.*

2.2 ADJACENT BUILDINGS POLICY

As per provision 2.6.3 of the *Provincial Policy Statement*, development and alterations to properties adjacent to the District should be evaluated for their impact on the heritage character of the District.

2.3 ETOBICOKE CREEK FLOODPLAIN SPECIAL POLICY AREA

A portion of downtown Brampton located in the Etobicoke Creek floodplain was designated a Special Policy Area by the Province in 1986 to enable some development to take place in the city's historic downtown. To help realize the vision for growth and revitalization in the Downtown, which is designated an Urban Growth Centre under *Places to Grow, the Growth Plan for the Greater Golden Horseshoe*, the City of Brampton prepared the Downtown Brampton Special Policy Area Comprehensive Flood Risk and Management Analysis in partnership with the Toronto and Region Conservation Authority (TRCA) to seek Provincial approval of a formal amendment to the provisions of the Special Policy Area in the Downtown Secondary Plan.

The Ministers of Natural Resources and Municipal Affairs and Housing granted final approval of the SPA update in April 2014, following endorsement by the TRCA and Brampton Council. Brampton Council adopted new detailed Secondary Plan policies and implementing zoning by-law, which came into effect in June 2014.

A portion of the Main Street South Heritage Conservation District falls within Special Policy Area 3D of Downtown Secondary Plan Area 7.

The Heritage Conservation District area was not the primary subject of the SPA review but the area was recognized as one in which a stable, low density residential character and built form will remain.

The SPA review resulted in slight boundary adjustments to the SPA reflecting updated flood lines. The new policies work to maintain the long term viability of the neighbourhood by enabling building additions and replacement subject to the flood protection requirements.

Of particular importance is that no new residential units (over those legally existing on May 7, 2014) are permitted in Special Policy Area 3D, unless safe access to flood-free lands can be achieved. This includes a restriction on the creation of new lots through consent unless it allows the new dwelling to have access to flood-free lands. All new structures within the SPA, including additions, require a permit and must be flood proofed to the Regulatory Storm elevation, to the satisfaction of the TRCA.

APPROXIMATE FLOOD PLAIN POLICY AREA

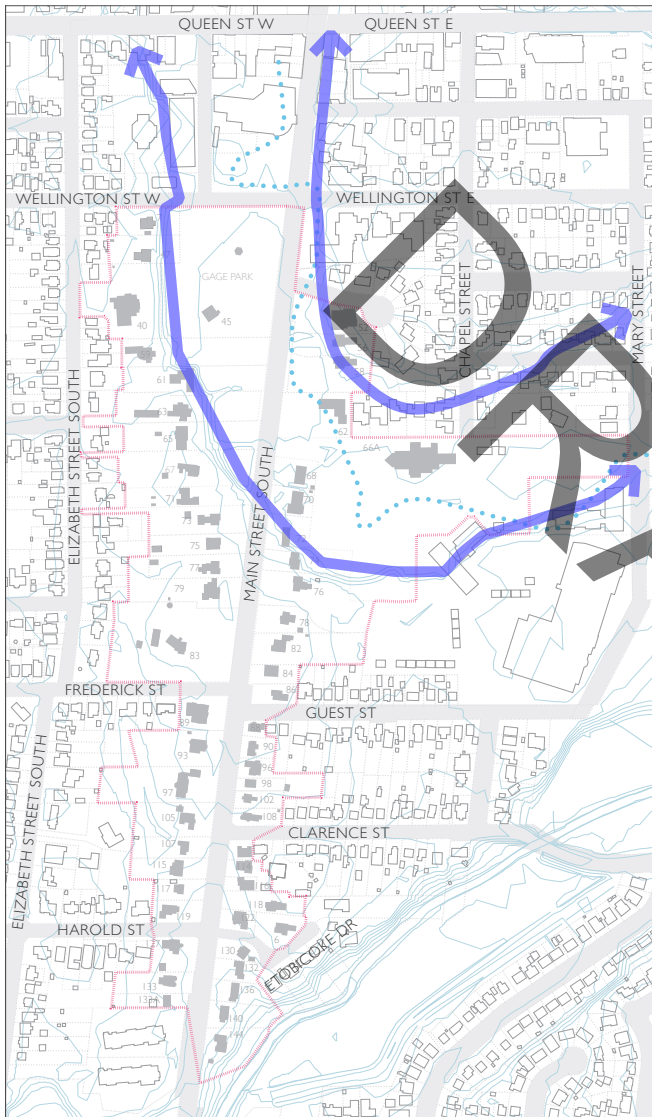

Approximate flood plain policy area

Proposed boundary

District properties

Approximate extent of flood plain policy near the District

Figure 13. The above diagram is an approximation and is for reference only. For the original and authoritative source refer to the Downtown Brampton Special Policy Area Comprehensive Flood Risk and Management Analysis and Special Policy Area in the Downtown Secondary Plan. (Source: ERA)

3.0 POLICIES & GUIDELINES

3.1 DISTRICT POLICY STATEMENTS

The District policies provide further direction for the interpretation and implementation of the Statement of Objectives set out in this Plan.

PROTECT

- » The unique heritage character of the District, as described in the Statement of Cultural Heritage Value and Heritage Attributes, shall be maintained and improved. This includes both private property and the public realm within the District.
- » An inventory of contributing properties shall be maintained by the City and made available to the public.
- » Contributing properties shall be maintained and enhanced, while generally demolition of contributing properties shall not be permitted.
- » Existing lot size and lot patterns within the District shall be conserved, and in most cases applications for lot severance shall be discouraged.

MANAGE CHANGE

- » To promote high design quality, major proposed changes, within or adjacent to the District shall be encouraged to undergo design review.
- » When evaluating applications that do not strictly conform to the guidelines, City Staff shall assess the applications to ensure that the proposed changes positively respond to the intentions of the District Plan.
- » All public works within and adjacent to the District shall be comply with this Plan.

- » All proposed changes, including alterations, additions, and new construction, within or adjacent to the District shall positively respond to the Plan, and may be required to submit a Heritage Impact Assessment at the request of City Staff.

FEEDBACK

- » Future changes to city planning documents, shall remain aligned with the content and implementation of the District Plan.
- » An inventory of Heritage Permit applications shall be maintained by the City. It will create a record of alterations to properties in the District. This inventory will inform the District Plan five-year review and how change is managed in keeping with the Plan's objectives.
- » From time to time, the District Plan shall be reviewed to ensure that outcomes align with the stated objectives, and to ensure the Plan has been useful. Amendments to the Plan shall be made as needed to allow the District to continue to evolve.
- » The City shall provide the public with information about the District to foster civic pride and celebrate the District's ongoing conservation.

The policies, guidelines, and procedures outlined in the District Plan provide guidance to property owners and residents within the Main Street South Heritage Conservation District, City staff, local councillors and other decision-makers involved in managing change within the District according to the stated objectives.

3.3 GENERAL PRINCIPLES

- (a) Avoid making changes or alterations that create a false sense of historical development, such as adding conjectural features or architectural elements from other buildings.
- (b) Preserve distinctive features, finishes, and construction techniques or examples of craftsmanship that characterize a property.
- (c) Respect the form, height, massing, proportions, and details of historic buildings.
- (d) Repair rather than replace heritage fabric and historic features. Where the severity of deterioration requires replacement of a heritage attribute, the new feature must match the old in design, colour, texture, and other visual qualities, and where possible, materials.
- (e) Understand the stylistic trends, the design intent, and the traditional use of building materials, which are important for proper conservation.
- (f) Use documentary, pictorial, or on-site evidence to inform the replacement of missing features.
- (g) Undertake conservation work with the assistance of qualified heritage professionals. To help determine when a heritage professional is needed, contact heritage staff at the City of Brampton for guidance and assistance.
- (h) Research conservation and maintenance options before initiating any work. This may include testing repair methods before undertaking work when there are no established conservation methods.
- (i) Test proposed interventions to establish appropriate replacement materials, quality of workmanship and methodology. This can include reviewing samples, testing products, methods or assemblies, or creating a mock-up. Testing should be carried out under the same conditions as the proposed intervention.

3.4 DISTRICT GUIDELINES

3.4.1 INTENT

These guidelines are intended to manage change and to conserve the existing unique architectural and cultural landscape character of the District.

They are intended to encourage and facilitate the conservation of the District, while recognizing the need for continuing adaptation and improvements to these resources.

Assistance in interpreting these guidelines is available from Heritage Staff.

3.4.2 LIMITATIONS

The guidelines do not force repairs or alterations and do not address interior alterations. They are not intended to promote historic replicas or the creation of a false sense of history.

3.4.3 BUILDINGS DESIGNATED UNDER THE ONTARIO HERITAGE ACT PRIOR TO THE ESTABLISHMENT OF THE CONSERVATION DISTRICT

Properties individually designated under Part IV of the Ontario Heritage Act prior to the establishment of the Main Street South Heritage Conservation District should be conserved in ways that protects heritage attributes identified in their respective Designation by-laws.

3.2 ARCHITECTURE

3.2.1 EXTERIOR WALLS AND CLADDING

Brick, stone, wood siding, and stucco are common exterior wall materials found in the District. These traditional wall materials are often key characteristics of historic buildings. As well, historic exterior walls include distinct architectural details that are important in defining the character of historic buildings. The character of historic walls can not easily be replicated by modern replacement materials.

If maintained properly, historic exterior walls are resistant to weathering and damage. They can often easily be rehabilitated using simple techniques, such as painting and gentle washing. Substituting traditional exterior wall materials should be considered only after other options for repair or replacement have been ruled out.

- (a) Conserve original historic exterior wall materials, such as brick, stone, wood, and stucco.
- (b) Investigate and document existing conditions and wall systems before repairing or replacing cladding.
- (c) Remove newer material that has been applied over historic finishes, except where these materials have become significant in their own right.
- (d) Do not cover or obscure historic decorative elements with cladding materials.
- (e) The restoration of exterior walls are encouraged if walls are clad in inappropriate materials (i.e. aluminum, vinyl, etc.) and where evidence exists of the original wall condition.
- (f) Finishes should be consistent with the historic style of the building.

TYPICAL WOOD CLADDING

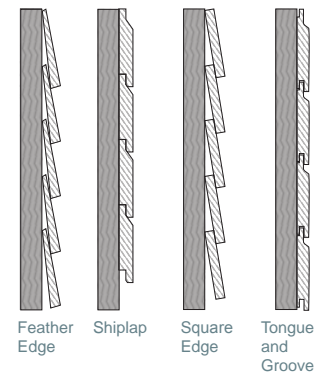

Figure 15. Exterior wood cladding variations. (Source: ERA)

INVESTIGATING CLADDING SYSTEMS



Figure 14. This project involved carefully removing part of the exterior wall in order to expose the interior structure and understand how to properly restore the exterior siding. (Source: ERA)

- (g) Do not cover existing masonry. Do not use aluminium, vinyl, or Exterior Insulation and Finish System (EIFS) to replace or cover historic exterior walls and cladding.
- (h) Masonry should be repaired with reclaimed material, when possible, to match existing.
- (i) When completing repairs or restoration, use material in kind with historic materials (i.e. lime-based mortars, bricks of similar colour and size). Do not repair with materials such as concrete or synthetic stucco, such as EIFS. The use of natural and locally sourced stone, such as Credit Valley stone, is encouraged.
- (j) In instances where replacement is required, replace in kind with similar material and using a matching cladding type.

APPROPRIATE CLADDING



Figure 16. Stucco cladding in this example has been maintained on the dormer. (Source: ERA)

INAPPROPRIATE CLADDING



Figure 17. On this house inappropriate siding detracts from the character of a building. (Source: ERA)

- (k) Use a qualified heritage mason for masonry repair and restoration work.
- (l) When repairing masonry, use appropriate mortars that are softer than surrounding masonry (e.g. lime-based mortar).
- (m) Regular painting and/or sealing of wood and stucco cladding should be undertaken to extend the life of original building fabric.
- (n) Do not use stucco or renders on façades where it did not originally exist.
- (o) In instances where replacement is required, replace stucco or historic render in-kind using a similar materials, texture and style. This should follow from an in-depth understanding of existing cladding system including both the surface and the backing material.
- (p) Use of traditional lime-based stucco or render is encouraged.
- (q) Repair or replacement of traditional stucco should aim to maintain the historic appearance and texture.

Historic Brick

Extra care is needed when working with historic brick walls. Compared to modern brick, pre-20th century bricks are relatively soft because they were fired/kilned at lower temperatures. As a result, they absorb and release moisture, expanding and contracting in the process, thus requiring softer lime mortar. The size of historic bricks are different from modern standard units. Consider the size of the existing brick before starting any masonry work on a historic brick building.

Use of Mortar

Joints between bricks should be re-pointed with an appropriate mortar, which for historic brick masonry, is typically lime-based. Lime-based mortars create a soft 'sacrificial' material that draws moisture and physical pressure away from the brick. As the mortar deteriorates it can be easily repaired. The cost and difficulty of matching replacement bricks is avoided. In contrast, modern, cement based mortar tends to be too hard and impermeable for use with historic brick, which is softer than modern bricks. Using hard mortars on historic brick can result in the accelerated weathering, moisture problems, and damage.

MASONRY REPAIR



Figure 18. This photograph shows reclaimed materials used for repairs. (Source: ERA)

REPOINTING

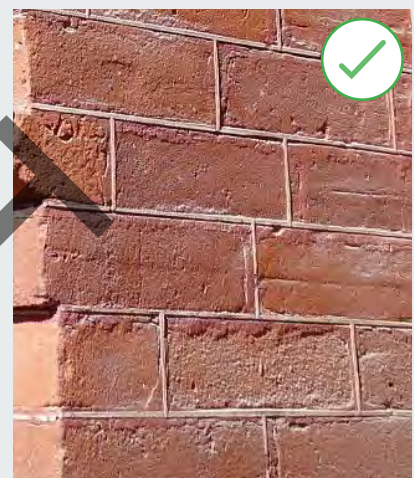

Figure 19. Left: Spalling as a result of improper maintenance. Right: Regular maintenance, such as re-pointing brick and/or stone masonry, is encouraged. (Source: ERA)

Renders

'Render' generally refers to a finish or finishing applied to an exterior wall and includes stucco. In the past, external lime renders were applied to both disguise and protect walls built of less stable materials such as rubble stone, porous brick or rough timber. Renders were later used as a stylistic element of architectural styles, such as Tutor Revival or Arts and Crafts, and inspired by late-medieval period buildings. Renders are often colour washed or lime washed to provide additional protection.

The Standards and Guidelines for the Conservation of Historic Places in Canada notes, "as these materials continued to evolve, synthetic versions were developed. These synthetic stucco and plaster materials have different characteristics and should be avoided when repairing traditional stucco or plaster...Materials with different physical characteristics will likely not properly adhere to one another, necessitating repeated maintenance in the near future." (2nd Ed. Page 243)

TRADITIONAL LIME-BASED STUCCO



Figure 20. Historic use of traditional lime-based stucco or render in the District at 93 Main Street South. (Source: ERA)



Figure 21. Close-up of 93 Main Street South traditional stucco work to show rich, irregular texture. (Source: ERA)

SYNTHETIC STUCCO



Figure 22. Detail and cut-away sample of the exterior wall showing the uniform texture of the synthetic stucco and the damaging to the masonry underneath. (Source: ERA)



Figure 23. Use of synthetic cladding over masonry at 300 King, Toronto. (Source: ERA)

3.2.2 FOUNDATIONS

Foundations play an important role in, and are significant features of the design of a structure. Foundations demonstrate the historic building methods, such as the use of stone to construct a 19th century house. Decisions about conserving foundations should be determined by both the condition of the foundation and its compatibility with the heritage character of the building.

- (a) Historic foundations exposed above grade should be maintained especially if they are visible as part of the building elevation.
- (b) Ensure proper surface drainage next to masonry foundations by maintaining downspouts which direct water away, removing accumulated organic matter from contact with ground floor masonry and foundations, and contouring soil and hard landscaped surfaces away from the building.
- (c) Ensure the historic finishes and textures of foundations is maintained. Match the historic textures and finishes when undertaking repairs or replacement.

AN EXAMPLE OF A EXPOSED FOUNDATION



Figure 24. This photograph shows exposed foundation above grade being maintained as part of the building elevation. (Source: ERA)

CONSERVATION OF AN EXPOSED FOUNDATION



Figure 25. Ensure the historic finishes and textures of foundations is maintained. Repair or replacement should match the historic texture and finishes, as is shown above. (Source: ERA)

3.2.3 ROOFS

Roofs are among the most important features of any building. These elements serve to define the building's form and style. They serve essential functions such as protection from the elements and structural support. As such, alterations to the roof must be carried out only after considering the building as a whole. Alterations to the roof may significantly alter the building's appearance, and as a result, may not be appropriate in all circumstances. Roofs often contain decorative elements that: visually enrich the roofscape, are key features of the architectural style of the building, and reflect good craftsmanship.

- (a) Use a type of roofing material that supports the character of an individual property. Where existing roofing is inappropriate, install more suitable materials when the existing roofing is replaced.
- (b) Where archival evidence exists, the reinstatement of historic materials, such as slate or wood shingles, and zinc or lead coated copper roofs is encouraged.
- (c) Avoid the use of plastic, metal, ceramic or other roof materials that were not traditionally used within the District and are unsympathetic to the character of the neighbourhood.
- (d) When altering or replacing a roof, retain the existing style, form, pitch, height, and details. Before making alterations, examine the roof and design new work based on this understanding. For example, alterations to a hipped roof should generally maintain the low sloping profile of this roof type.
- (e) Avoid raising the roof to accommodate upper storey additions; consider the use of a dormer instead.

- (f) Install skylights in an unobtrusive location; that are not visible from the public realm. Utilize flat skylights that blend in with the roof, and avoid sculptural or bubble-style skylights.
- (g) Avoid flat roofs as most roofs within the District are sloped (gabled, hipped, etc.).
- (h) Locate roof-mounted units such as satellite dishes and antennas in a location and manner that do not damage or obscure heritage attributes and are not visible from the public realm.
- (i) Retain roof details such as the cornice, soffit, fascia, and gable ends or reinstate historic details where archival evidence exists. Remove items, such as metal fascia and soffits, that conceal original architectural detail.
- (j) Use of traditional materials for flashing and finishes is encouraged. Use traditional or matching materials for flashing, rain gear and downspouts, and finishes that are consistent with the historic style of the building.
- (k) Conserve historic eaves, downspouts, and soffits.

SUPPLEMENTARY GUIDANCE FOR ROOFS, DORMERS AND CHIMNEYS



Figure 26. Examples of roof elements. (Source: ERA)

Identify and maintain the main massing, shape and profile of the roof when making alterations. Some roof shapes found in the District are pictured below.



Figure 27. Front gable. (Source: ERA)



Figure 28. Hipped. (Source: ERA)



Figure 29. Low sloping. (Source: ERA)

3.2.4 DORMERS

- (a) Coordinate the size, scale and style of new dormers with original dormers, where they exist.
- (b) Design dormer to be consistent with the main roof form.
- (c) Avoid removing or obscuring historic dormers.
- (d) Do not add dormers on the principal façades where they did not originally exist.
- (e) Dormer window additions should use materials and massing that are complementary to existing gable slopes, roof lines and window openings.

3.2.5 DECORATIVE ARCHITECTURAL ELEMENTS

- (a) Document and understand decorative elements prior to repair or restoration.
- (b) Conserve decorative elements, such as barge-board, fascia, finials, etc.
- (c) Repair rather than replace character-defining decorative elements.
- (d) Where character-defining elements are too severely deteriorated to repair and where sufficient physical evidence exists, replicate them with new elements that match the forms, materials and detailing.
- (e) Where archival evidence exists, consider reinstating decorative elements or missing features using forms, materials and detailing are based on sufficient physical, documentary and/or oral evidence.

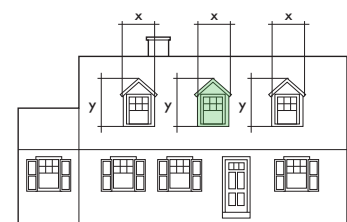

Figure 30. Appropriate dormer designs (Source: ERA)

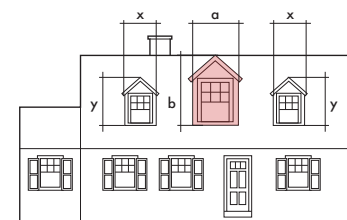
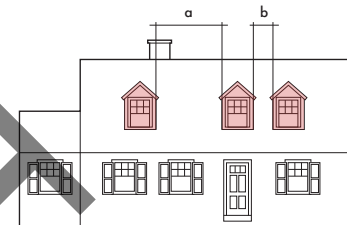

Figure 31. Not appropriate dormer design (Source: ERA)

SUPPLEMENTARY GUIDANCE FOR ARCHITECTURAL DETAILS



Figure 32. Completing detailed measurements of this column base was the first step in conserving this column. (Source: ERA)

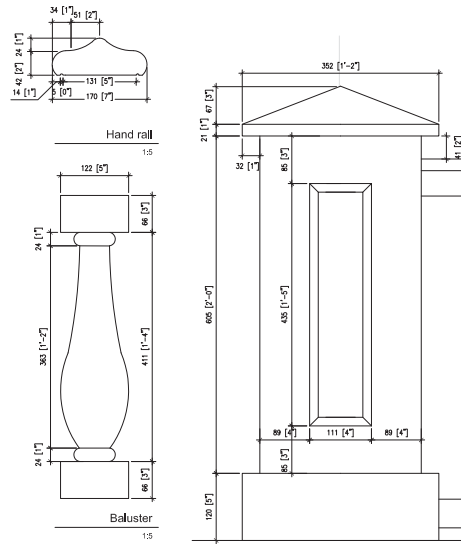

Figure 33. Decorative elements often correspond to other features of a building in terms of size, proportion and style. Consider the relationship between different elements as a system, and each element as component of larger composition. (Source: ERA)



Figure 34. In this case, the decorative element was not considered when making changes to the building. As a result, it was partly obscured. This should be avoided. (Source: ERA)

3.2.6 WINDOWS

Windows are among the key elements of a building's character and style. They define the proportions of the main façades, provide important stylistic cues, and largely define how a building appears within a streetscape. Windows and their surrounding elements are commonly key character-defining elements of historic architecture. They also provide important functions such as insulation and weather protection, security, lighting and ventilation.

Each window is comprised of a number of components that are an integrated system. Conserving traditional window systems in heritage buildings protects not only the appearance of the building, but also respects original functions, such as air circulation and lighting. As well, traditional window systems can have a prolonged service life because individual components can be refurbished, repaired or replaced. Contemporary window systems, in contrast, tend to be manufactured as combined units that must be replaced entirely. For these reasons, the guidelines below focus on conserving and prolonging the use of historic windows and their components.

- (a) Conserve historic windows and their original features, including original features, including location, type, size, and profiles.
- (b) Maintain design details and decorative elements (i.e. lintels, sills, shutters, voussoirs, etc.) of original windows.
- (c) Repair rather than replace the functional and decorative features. If replacement of a feature is necessary, replace only the deteriorated feature in kind rather than the entire unit, matching the materials, design and dimensions of the original.
- (d) Replace a historic window only as a last resort where the window is deteriorated beyond repair.



Figure 35. This photos shows a window opening bricked in. (Source: ERA)

RHYTHM AND PROPORTION



DO maintain the rhythm and proportion of existing windows and dormers.



Do NOT break the rhythm and proportion of existing windows and dormers.

WINDOW INFILL

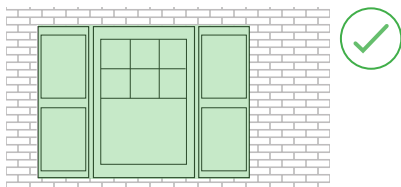

DO reinstate infilled windows

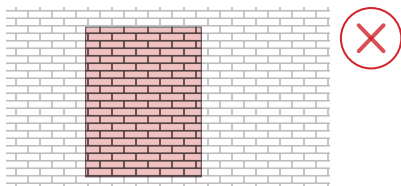

Do NOT infill windows openings

Figure 36. Window diagrams.
(Source: ERA)

- (e) If windows units are beyond repair, the replacement window should maintain size, proportions, materials, and dimensions of the entire window, including frame and lights (or windowpanes). Conserve the window opening and do not adjust its size to accommodate a different window.
- (f) Avoid the replacement of wooden windows with aluminum, coated metal, or vinyl units. Synthetic materials rarely duplicate the texture and detail qualities of original materials and should not be used. Avoid the use of snap-in muntins or other inauthentic architectural details.
- (g) Do not enclose window openings as this will significantly change the architectural composition of the building. Consider re-opening enclosed or blocked windows.
- (h) Do not convert window openings to doors.
- (i) If new windows are added, they should continue the window patterns, rhythm and proportions of the existing structure especially on elevations visible from the public realm.
- (j) New window openings on street facing façades must not interrupt the rhythm/historic pattern of windows or the architectural style of the building. For example, some architectural styles, such as Georgian Revival, require windows to be symmetrical across the front façade.
- (k) The reintroduction of traditional storm windows that have been replaced by aluminum or vinyl is encouraged. Avoid the use of aluminum or vinyl storms on public facing facades.
- (l) Undertake energy conservation work in a manner that maintains and does not damage, conceal or remove original windows.

- (m) Maintain and repair wooden shutters. Replace original shutters only if they are severely deteriorated. When necessary, replace in kind duplicating all shutter details.
- (n) Ensure shutters are sized and shaped appropriately for the windows. Fasten shutters to the window casing and avoid attaching shutters to the wall.
- (o) The use of original wood storm windows and proper weather-stripping, are the preferable solution to increase energy efficiency for historic window openings. Interior storm windows are a secondary solution for thermal efficiency. New storm windows are to be designed to avoid altering or obstructing character defining elements of a house, such as historic window patterns.



Figure 37. This photo shows operable storm shutters. (Source: City of Brampton)

Energy Efficient Windows

Parks Canada's Standards and Guidelines for Conservation of Historic Place in Canada recommends "complying with energy efficiency objectives in upgrades to character-defining doors, windows and storefronts by installing weather-stripping, storm windows, interior shades and, if historically appropriate, blinds and awnings. The energy efficiency of the building envelope and systems as a whole should be considered[...] Working with specialists to determine the most appropriate solution to energy efficiency requirements with the least impact on the character-defining elements and overall heritage value of the historic building."

Standards and Guidelines also encourages "maintaining the building's inherent energy-conserving features in good operating condition, such as operable windows or louvered blinds for natural ventilation." [Standards and Guidelines, 2nd Ed. Page 158]



Figure 38. This photo shows storm shutters fixed in place. (Source: City of Brampton)

WINDOW CONSERVATION, REPAIR AND REPLACEMENT

APPROPRIATE



INAPPROPRIATE

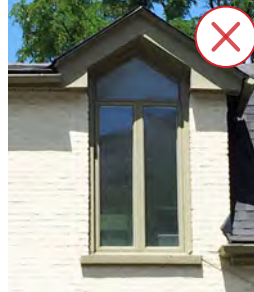

- ✓ DO maintain design details and decorative elements (i.e. lintels, sills, shutters, voussoirs, etc.) of original doors and windows.
- ✓ DO maintain size, proportion, materials, and dimensions if windows are beyond repair.
- ✓ DO restore storm windows that have been replaced by aluminum or vinyl.
- ✓ DO undertake energy conservation work in a manner that maintains original windows and associated features.

- ✗ Do NOT discard design details and decorative elements of original doors and windows.
- ✗ Do NOT change size, proportion, materials, and dimensions if windows are beyond repair.
- ✗ Do NOT replace wooden windows with aluminum, coated metal, or vinyl units.
- ✗ Do NOT undertake energy conservation work in a manner that replaces original wood storm windows with aluminum, coated metal, or vinyl units.

- ✓ DO maintain and repair lintels, or replace with a matching type if necessary and avoid painting or replacement.
- ✓ DO maintain historic window patterns and proportions.
- ✓ DO retain window hardware, if possible.
- ✓ DO finishes should be keeping with the historic style of the building.
- ✓ DO salvage and repair window frames where possible, or replace with matching material.
- ✓ DO retain or repair sills and lintels or replace with matching materials.
- ✓ DO retain or repair shutters.

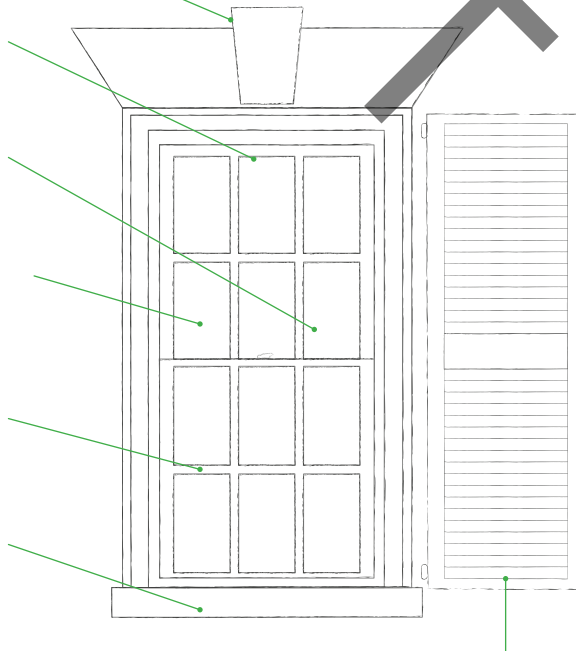

Figure 39. Window Conservation. (Source: ERA)

3.2.7 DOORS AND ENTRANCES

Doors and entrances are among the most conspicuous feature of a building and are often central to architectural design. They are also critical to the building's function. Daily use makes doors susceptible to accelerated wear and so they are often replaced. However, replacement doors that are not a suitable design can diminish the character of the entire building. The following guidelines aim to balance functional requirements of doors and entrances and the conservation of the building's character.

- (a) Retain the functional, proportional and decorative features of a door, particularly if it is a primary entrance. These features include the door and its frame, sill, head, jamb, moldings, and any flanking windows (e.g. transom and sidelights).
- (b) Maintain the rhythm and proportion of existing doors, and entrances.
- (c) Conserve historic door hardware such as the knobs, hinges, locksets, and knockers.
- (d) Replace a historic door only as a last resort where the door is deteriorated beyond repair.
- (e) Do not add new door openings on the original, street-facing façades of contributing buildings.
- (f) Maintain size, proportion, materials, and dimensions when replacing doors and entrance features that are beyond repair.
- (g) Do not replace traditional wooden doors with aluminum, coated metal, or vinyl units. Synthetic materials rarely duplicate the texture and detailed qualities of original materials and should not be used.

- (h) Undertake energy conservation measures so as not to conceal or remove historic features. Some appropriate energy conservation approaches include installing weather-stripping, adding appropriately designed and removable screen doors, storm doors, or adding interior shades.
- (i) Metal screen doors, particularly on street-facing façades, are discouraged. Screen doors should be wood.
- (j) Do not enclose door openings or convert door opening to windows.

DRAFT

EXAMPLES OF DOORS AND ENTRANCES



Figure 40. The door and entryway details can be defining features of a building. These have been maintained on this house. (Source: ERA)



Figure 41. This is an example of how a main door and entryway details establish a connection between the building and landscape. (Source: ERA)

SUPPLEMENTARY GUIDANCE FOR DOORS AND ENTRANCES

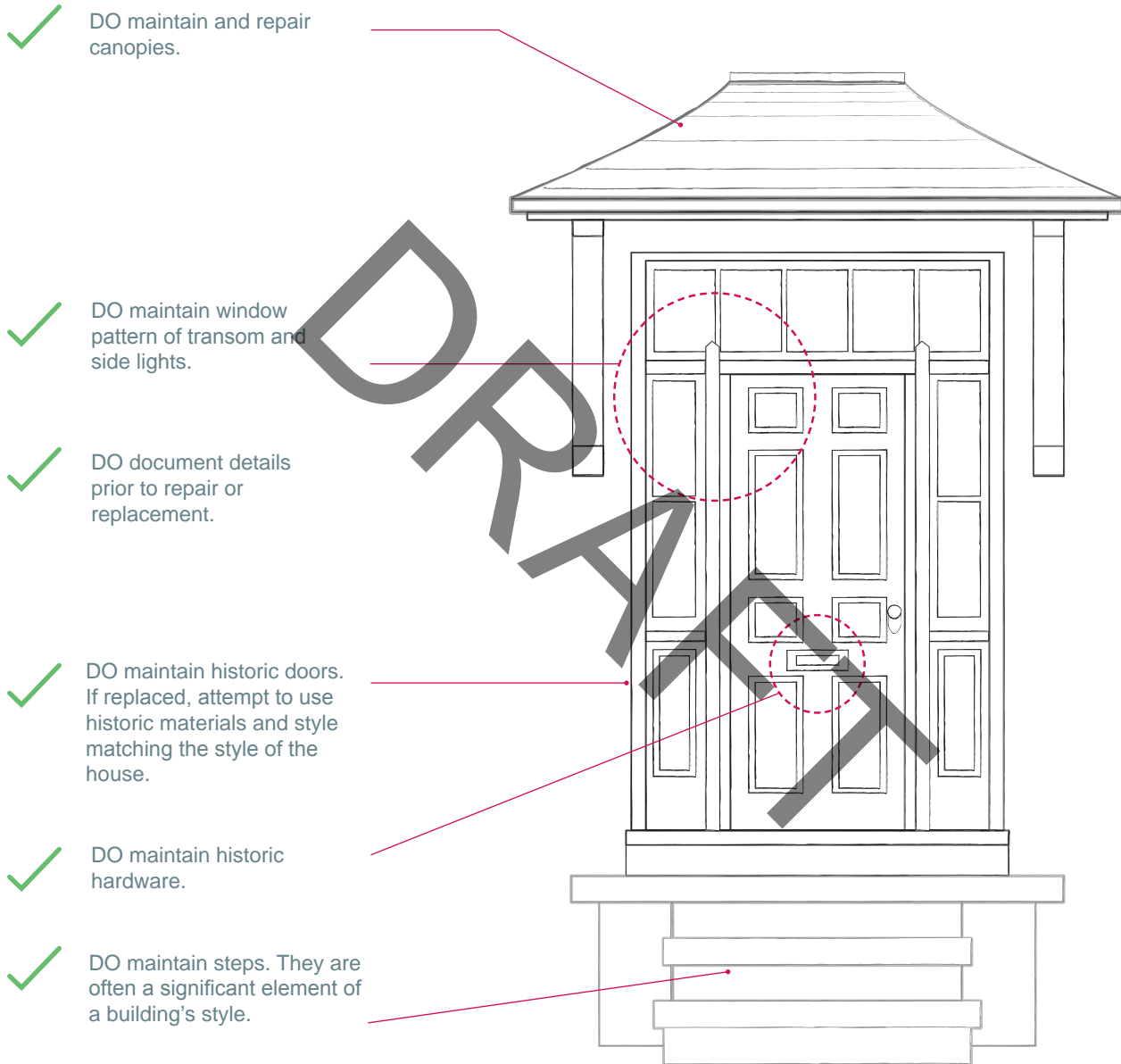

Figure 42. Guidance of doors and entrances. (Source: ERA)

3.2.8 PORCHES, VERANDAS AND PORTICOS

Front porches, verandas and porticos are key visual elements of many historic building styles that also contribute to the streetscape. They create a mediating space between the interior and exterior, and the private and public realm. Historically, porches, verandas and porticos were features used to embellish the style of the main building by adding a range of detailed woodwork, columns, or brackets, and expressive roofs or roof-top decks.

For this reason, any alterations or additions to porches, verandas and porticos requires special attention to design details. The guidelines below are intended to support the maintenance and conservation of these features.

- (a) Do not enclose front porches as it negatively impacts the visual character of both the heritage resource and the streetscape.
- (b) Repair deteriorated porches and porch elements, such as balusters, railings, columns, following recognized preservation methods.
- (c) Document and understand elements prior to repair or restoration.
- (d) Repair rather than replace key elements.
- (e) Where elements are too severely deteriorated to repair, and where sufficient physical evidence exists, replace them with new elements that match the forms, materials and detailing of sound versions of the same elements.
- (f) Where incompatible alterations, such as enclosure of open porches, or use of incompatible materials have occurred, consider reconstructing the original state if adequate physical or documentary evidence exists.

SUPPLEMENTARY GUIDANCE FOR PORCHES, VERANDAS AND PORTICOS

AN EXAMPLE OF RESTORING A FRONT PORCH

- 1 Assess and document the current condition**
In this case, severe rot and weathering made repair impossible. Reconstruction was identified as a suitable conservation strategy.



Figure 43. Existing condition. (Source: ERA)

- 2 Consult available documentation**
This archival photograph was used to understand the original condition of the porch.

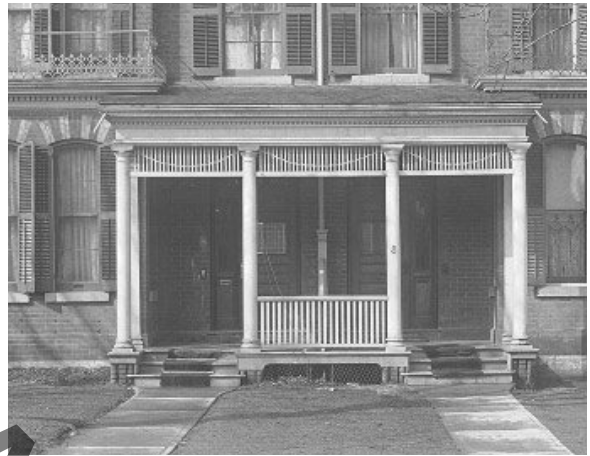

Figure 44. Historic Photograph showing original condition. (Source: Toronto Archives)

- 3 Reconstruct the porch**
A detailed plan was developed to reproduce the porch based on site and archival research.



Figure 45. Conservation drawing of reconstruction. (Source: ERA)

3.2.9 CHIMNEYS

- (a) Maintain historic chimneys and repair using traditional materials.
- (b) Retain the historic location, style, and materials of chimneys.
- (c) Ensure new chimneys respect the historic architectural style of the building or are not visible from beyond the public realm.

3.2.10 MECHANICAL / UTILITIES

- (a) Locate new elements, such as skylights and utilities (HVAC and or communications systems, etc.), away from the principle façade to ensure that they are not visible from the public realm.
- (b) Mount solar collectors flush on rear-facing roofs, or on the ground in an inconspicuous location.
- (c) Screening should be considered as a way to limit potential visual impact.



Figure 46. An example of screening where a heat pump would otherwise be visible on a corner lot. (Source: ERA)

3.2.11 SECONDARY STRUCTURES (GARAGES, COACH HOUSES AND OTHER ACCESSORY BUILDINGS)

- (a) Retain and preserve garages, coach houses and other accessory buildings that contribute to the overall historic character of the individual building site or the district.
- (b) New garages and accessory buildings should generally be located at the rear of the lot, respecting the traditional relationship of such buildings to the primary structure and the site. They should not be the principal feature of the front façade.
- (c) Secondary structures that are clearly visible from the street should be smaller in scale than the main building. Locate portable shelters (e.g. vehicle shelters) at the rear of the property in a location not easily visible from the street/public realm.
- (d) Integrate secondary structures with existing site conditions. Refer to guidelines relating to site planning, including New Construction (Section 3.4) and Landscape and Streetscape (Section 3.5).
- (e) Position attached garages back from the front façade of the house (See Diagrams 'Location of Secondary Buildings' on page 47).
- (f) Where an attached garage that projects past the principal elevation is necessary, ensure that the entry and garage doors are not facing Main Street South (See Diagrams 'Location of Secondary Buildings' on page 47).
- (g) Consider incorporating design cues from the primary structure on the site into new accessory structures while ensuring they are subordinate in terms of size and massing.

- (h) Use a roof form and pitch that is complementary to the primary structure.
- (i) Avoid integrated garage additions.
- (j) Ensure that all additions to or new construction of garages and accessory buildings do not negatively impact significant trees on the property.
- (k) Additions and new construction of secondary structures should utilize materials (such as wood, brick or stone) that are complimentary to the historic style of the main building.
- (l) Garage doors should correspond to the style of the garage and the main building.
- (m) Screening should be considered as a way to limit potential visual impact on historic buildings or landscapes. Screening, such as fencing or vegetation, can be used to block views of secondary building from the street as a way to maintain the historic landscape design or sitting.

SUPPLEMENTARY GUIDANCE FOR SECONDARY STRUCTURES

LOCATION OF SECONDARY BUILDINGS

DETACHED

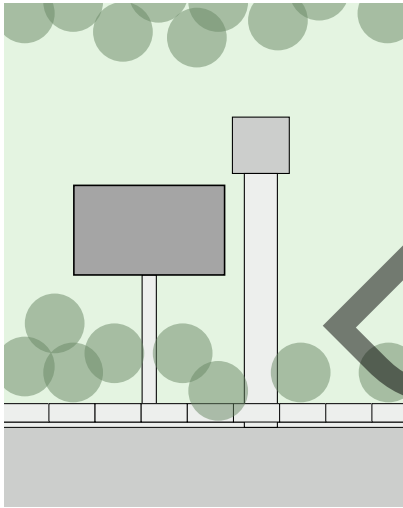

Figure 47. Detached garages should be located as an ancillary building to the rear. (Source: ERA)

SIDE

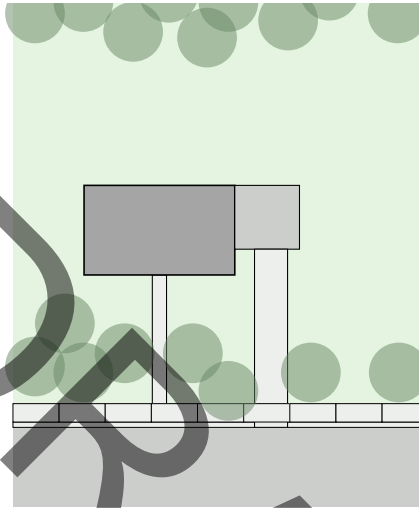

Figure 48. Attached garages should be setback from the front façade of the house. (Source: ERA)

PROJECTING

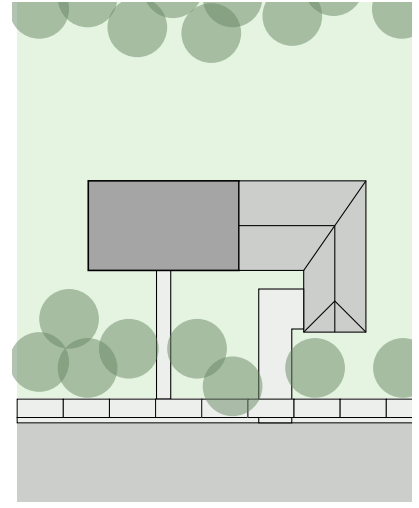

Figure 49. If a garage projects beyond the front façade, the entry should be located on the return and not the front elevation. (Source: ERA)

EXAMPLES OF SECONDARY STRUCTURES



Figure 50. This detached garage addition is set back from the main façade to help maintain the massing and profile of the main building. (Source: City of Brampton)



Figure 51. This garage addition uses complimentary materials and building form to maintain the character of the house. (Source: City of Brampton)

3.3 ADDITIONS

Buildings evolve over time to provide additional space and to accommodate to new patterns of use. New additions to historic buildings can help historic buildings address changing circumstances while conserving its cultural heritage value and heritage attributes. Successful additions to historic buildings conserve key characteristic features, historic materials, and spatial relationships. They are distinctive yet complementary to the historic architecture. They reflect contemporary uses while respecting a building's original design. This is accomplished by understanding the design of the historic building, identifying opportunities and limitations for new construction, and by paying close attention to materials, building form, landscape and site planning. An addition may significantly alter the building's appearance, and as a result, may not be appropriate in all circumstances. The guidelines below are intended to support this evaluation process.



Figure 52. The rear addition on the left of the photograph uses complimentary materials and a similar roof shape to conserve character of the house. (Source: City of Brampton)



Figure 53. This addition was designed in a way that adds to the character of the house. It reflects the existing style and material palette. For example, the stone base references the existing stone foundation. (Source: ERA)

- (a) New construction within the District should not attempt to mimic the styles of the past. Design additions to be compatible with the heritage building, but also sufficiently different as to distinguish old from new.
- (b) New additions should be visually distinct to ensure the original form of the building remains visible.
- (c) Distinguish any addition from the heritage resource, but maintain visual continuity between the two. This can be achieved by stepping the addition back from the side elevations of main building.
- (d) Consider distinguishing an addition from the original building through the careful use of a different yet complementary cladding material. For example, incorporating a board and batten addition for a brick house.
- (e) Locate new additions away from the main façade of the building.

- (f) New additions are to maintain the historic shape of the principal building. For this reason, additions may be located to the rear, on secondary elevations, or set back from the main elevation. Additions visible from the street will require greater mitigating considerations than rear additions.
- (g) Do not raise the roof to accommodate upper storey additions; consider the use of a dormer instead.
- (h) Additions to buildings are to compliment rather than detract from, the architectural style and character of the principal building and those surrounding it.
- (i) Maintain existing additions that are compatible with the historic style of the building.
- (j) Additions, exterior alterations, or related new construction must not remove historic features that characterize the property.
- (k) Design new additions to be compatible with the massing, size, scale, and architectural features of heritage resources to protect the historic integrity of the building, its site and surroundings.
- (l) Create any new additions or related new construction so that the essential form and integrity of the historic building is not compromised if the new work is removed in the future.
- (m) Consider the roof shape of nearby buildings and original style of the building when designing a roof shape for a new addition.
- (n) New additions are to respond to features of the buildings, such as its proportions, window placement patterns and/or massing.

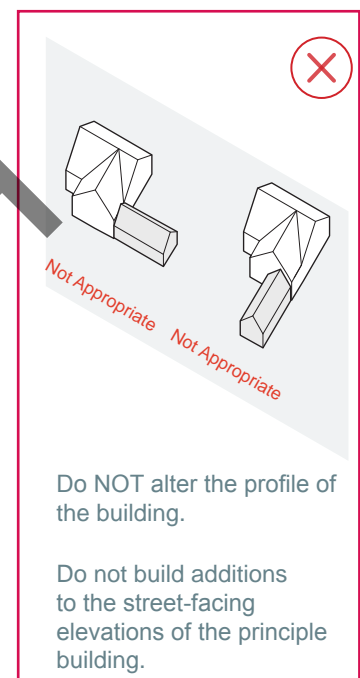
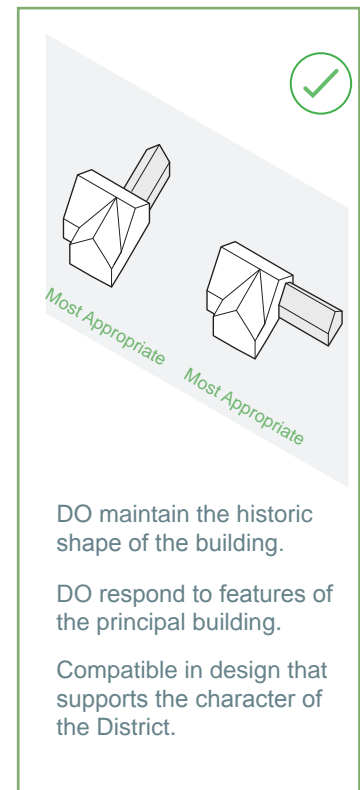

Figure 54. Schematic diagram of a one-storey addition illustrating guidelines. Other forms of additions would be possible for the house illustrated here. (Source: ERA)



Figure 55. This side addition fits well with the main building. It is set back from the side elevation, its windows are in proportion to the original windows, and it is clad in a material that compliments the original brick. (Source: City of Brampton)



Figure 56. This rooftop addition is not in keeping with the character of the house. It changes the basic shape of building and uses a material palette that is not complimentary to the rest of the building. The window in the addition does not fit with the size and location of other windows. (Source: ERA)

- (o) Ensure that the addition is ‘subordinate’ to the heritage building. This means the scale and form of the addition does not diminish or visually overpower the main building.
- (p) Rooflines of additions should not extend above the roofline of the original building.
- (q) Roof material, shape and style should correspond with the character and style of the rest of the building, a well-considered design rationale, adjacent properties, and the overall District.
- (r) Contemporary style additions that respect the Heritage Conservation District Plan guidelines are possible.
- (s) Window patterns and proportions of additions should reflect windows of the existing structure. On elevations visible from public streets, make the relationship of solids to voids compatible as well.
- (t) Avoid odd window shapes such as octagons and triangles.
- (u) Maintain the general style, proportion and rhythm of existing windows.
- (v) Windows and doors should be of a high quality. The style of the window should correspond with the character and style of the rest of the building, and demonstrate a well-considered design rationale.

3.4 NEW CONSTRUCTION

The District includes an eclectic mix of architectural styles including variations on Gothic Revival, Italianate, Queen Anne, Arts & Crafts, Craftsman Bungalow and Cape Cod Cottage and Ranch. Modernist and contemporary structures also contribute to the architectural character of the District. The guidelines below are intended to ensure new buildings contribute to this variety while conserving and enhancing the character of the District.

- (a) New construction should reflect the characteristic elements of the District, which include: building design, site composition, orientation, circulation, and ancillary structures. Urban design considerations, such as siting, orientation, and circulation on the property are priorities.
- (b) Read these guidelines for new construction together with all other guidelines in this plan, particularly those addressing Landscape and Streetscape (Section 3.5).
- (c) Design new buildings to be compatible with adjacent buildings within the District, in terms of scale, massing, proportion, height, setback, and entry level.
- (d) New construction should be well designed to relate and to fit in with the character of the District and enhance the neighbourhood.
- (e) Height and massing of new buildings should be within the established range within the District of 1-1½ and 2-2½ storeys.
- (f) Consider the roof shape of nearby buildings and when designing a roof shape for a new building.
- (g) Good craftsmanship and execution of design and materials is encouraged.

- (h) New construction within the District should not attempt to copy the styles of the past but rather be complimentary in design and enhance the evolution of the District.
- (i) Principal façades and elements that are visible from the public realm are priorities. In instances where the proposed work is not visible from the public realm, greater flexibility will be applied in the evaluation of proposals.
- (j) Use high quality materials found within the District, such as brick, stone, and wood.
- (k) Use authentic materials. Materials made to look like other materials, such as concrete that is scored to look like brick, are not appropriate.
- (l) Avoid the use of poor quality materials, such as synthetic stucco (EFIS) and vinyl. Traditional materials, such as stone, brick and traditional renders, will help ensure new construction is in keeping with the character of the District and that be more durable.
- (m) Design new construction so that the overall character of the site, site topography, character-defining site features and trees are retained.
- (n) Site new construction to be compatible with surrounding buildings that contribute to the overall character of the historic district in terms of setback, orientation, spacing, and distance from adjacent buildings.
- (o) Landscaping for new buildings are to comply with guidelines found in this plan including in Landscape and Streetscape (Section 3.5).
- (p) Maintain one of the two following building orientations found within the District (See the following page titled 'Examples of Building Orientation'):

- i. Perpendicular Orientation: The majority of buildings within the District are oriented towards and address Main Street South. They are sited perpendicular to the street.
 - ii. Angular Orientation: Some houses are sited at an angle from Main Street South, creating a buffer from the street and a picturesque setting (such as 83 Main Street South).
- (q) Design new construction in a way that will maintain existing trees.

DRAFT

EXAMPLES OF BUILDING ORIENTATION

PERPENDICULAR ORIENTATION

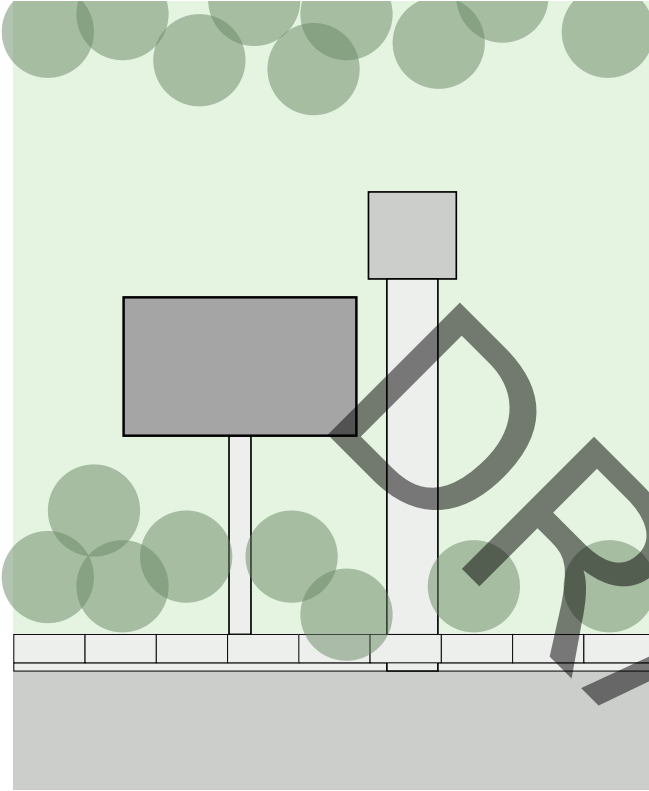

Figure 57. Diagram of perpendicular orientation. (Source: ERA)

ANGULAR ORIENTATION

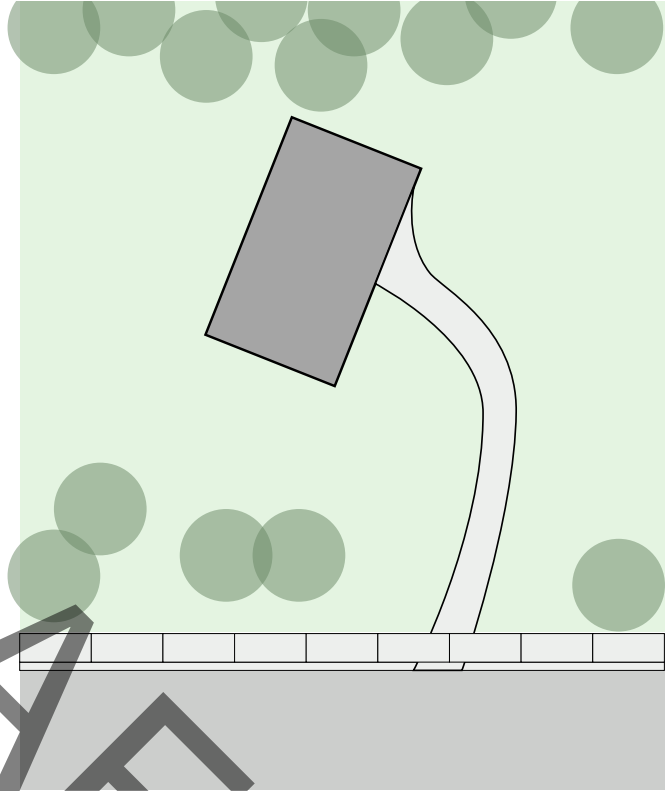

Figure 58. Diagram of angular orientation. (Source: ERA)



Figure 59. 78 Main Street South is sited perpendicular to Main Street. (Source: ERA)



Figure 60. Angular siting of 83 Main Street South creates a picturesque setting. (Source: ERA)

EXAMPLES OF NEW CONSTRUCTION



Figure 61. This new house in an Oakville Heritage Conservation District is a contemporary design, yet is sensitive to the heritage character of the area through the use of complementary materials and proportions. (Source: ERA)



Figure 62. This house is an example of a contemporary design that draws on the historic architectural design. (Source: City of Brampton)



Figure 63. This newly built house in Markham shows how historic materials and building forms can be interpreted in a contemporary manner. (Source: City of Brampton)

3.5 LANDSCAPE AND STREETScape

The district landscape is shaped by a topography of natural features such as the Etobicoke floodplain. Historically buildings and landscape design responded to opportunities and constraints created by topography and grading. Changes to grading and topography can affect the historic siting, visibility or usability of historic buildings and landscapes and should be carefully considered.

3.5.1 LANDSCAPE AND STREETScape, GENERAL

- (a) The foreground, near the street:
- i. Set new construction back from Main Street South so that it relates to the setbacks of adjacent buildings.
 - ii. Maintain mature trees and plantings in front of houses to contribute to the street tree canopy.
 - iii. Preserve mature trees immediately adjacent to the street; these are of particular importance to the character of the District.
- (b) The middle ground, built area:
- i. Position houses, additions, garages or other ancillary buildings in the middle ground.
 - ii. Design new houses to be compatible with adjacent buildings, in terms of scale, massing, height, setback, and entry level (see Section 3.4 New Construction).
- (c) The background, behind the built area
- i. Take special measures to ensure that new development and construction protects and avoid harming significant trees in the background. Mature trees in the backyards of properties within the District and of adjacent properties create an important visual backdrop the District's architecture.

- ii. Ensure that any additions, coach houses, rear garages, sheds and other ancillary buildings are not visible above the roof line of houses as the primary structure.
- (d) In general, plant new large canopy trees in the foreground, middle ground and background to maintain the park-like setting of the District.
- (e) Conserve historic topographical and grading patterns when undertaking alterations to building and landscapes and with new construction. For example, alterations to a house located on a rise of land should conserve this feature.
- (f) Conserve architectural design features that are integrated with topographical features.
- (g) Conserve existing landscape terracing.



Figure 64. 7 Wellington Street, an example of a house on a raised site. (Source: ERA)

ARCHITECTURE DESIGN FEATURES INTEGRATED WITH TOPOGRAPHICAL FEATURES

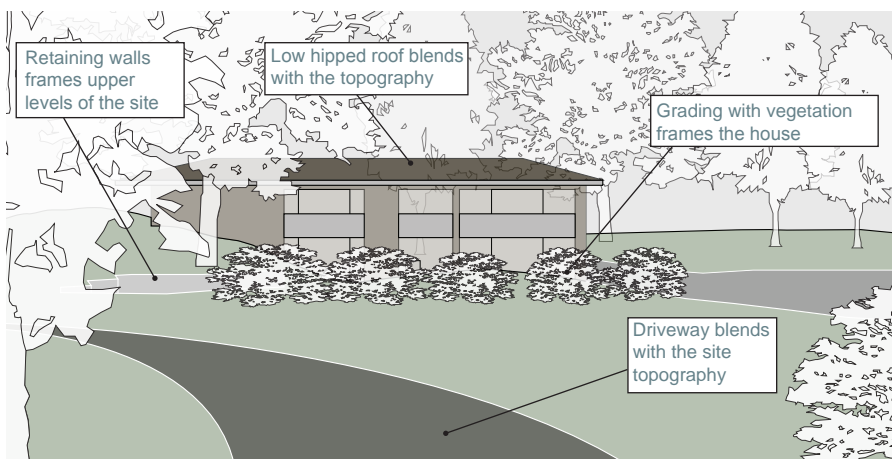

Figure 65. Diagram of 61 Main Street South, an example of architecture and landscape design responding to topography and grading. (Source: ERA)

FOREGROUND, MIDDLE GROUND AND BACKGROUND ELEMENTS OF A SITE

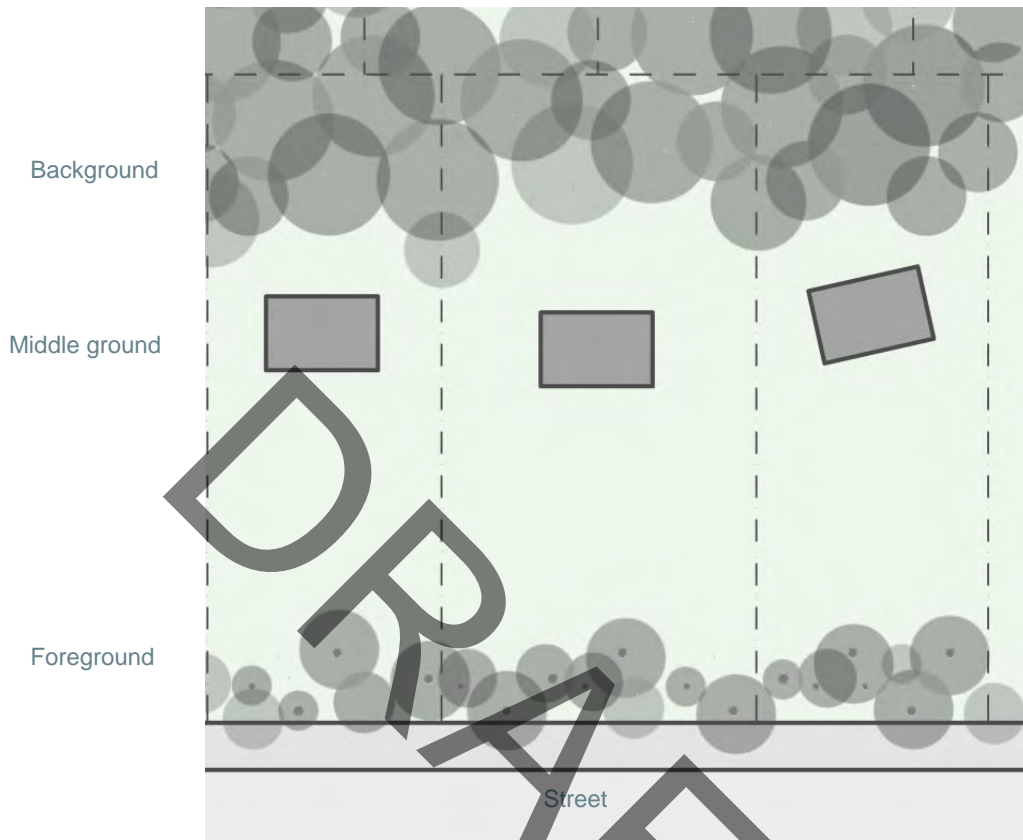

Figure 66. Diagram of Landscape elements. (Source: ERA)



Figure 67. Photograph of Landscape elements. (Source: ERA)

3.5.2 CIRCULATION (DRIVEWAYS, WALKWAYS, LANEWAYS)

- (a) Driveways should be used as secondary access to the house, with walkways leading from the front door entrance to the street.
- (b) Parking spaces should not be in front of the main building; locate parking to the side or rear.
- (c) Circulation routes should maintain the general style or typology of historic approaches to main buildings. Predominant types within the District are illustrated on the following page.
- (d) Preserve laneways that provide access to properties from Elizabeth Street. Only three such laneways remain within the District, and serve as illustration of the District's evolution.
- (e) Use paving treatment (i.e. stone or brick unit pavers, etc.) to distinguish walkways from driveways.
- (f) Consider use of traditional paving materials such as stone or gravel to compliment the historic style of the house.
- (g) Do not re-grade land in areas visible from the street to create driveways sloping to below grade, or basement level parking.
- (h) Treat driveways as part of design landscape.
- (i) The driveway should not cover a greater area than other landscape elements.

PREDOMINANT DRIVEWAY TYPES WITHIN MAIN STREET SOUTH

PERPENDICULAR

The driveway and walkway are separate.

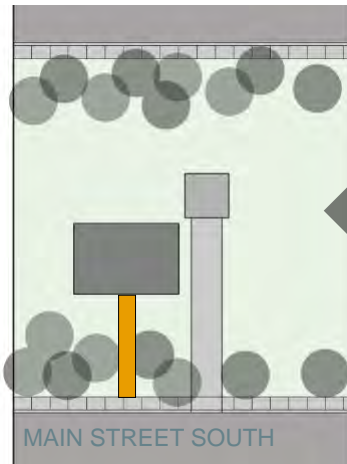

Figure 68. Walkway at 117 Main Street South is distinguishable from driveway. (Source: ERA)

CURVILINEAR

Often found on properties with post-war suburban style homes.

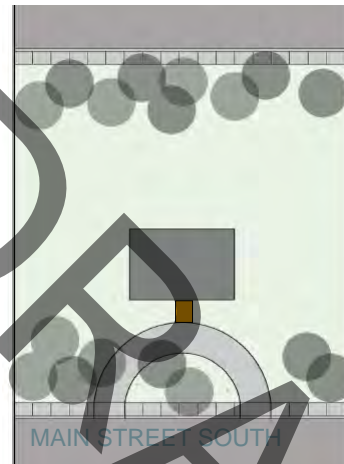

Figure 69. Curvilinear driveway at 68 Main Street South. (Source: ERA)

MEANDERING

Often on older estate lots. Some of these still have laneways that provide access from Elizabeth Street as well as Main Street South.

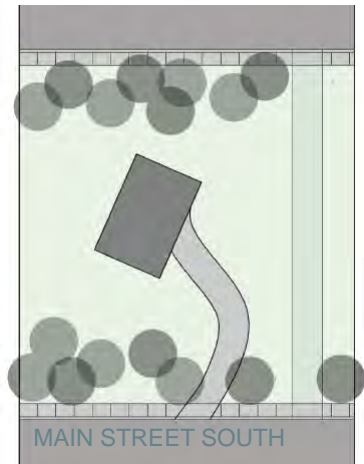

Figure 70. Meandering driveway at 63 Main Street South. (Source: ERA)

3.5.3 LANDSCAPE FILTERS AND SCREENS

- (a) A wide range of hedges, decorative metal fences and wooden fences are used as screens for privacy along side yards are observed within the District and are permissible.
- (b) Conserve and maintain the following conditions found within the District:
 - i. The pattern of mature canopy trees contained within landscaped berms, and
 - ii. The pattern of mature canopy trees scattered in front yards, which provides a filter between the street and the house and should be maintained.
- (c) Visual transparency between the trunks and under the canopy of front yard trees to the houses beyond is encouraged.
- (d) Avoid the use of fencing and hedges adjacent to the street as filters in front yards.
- (e) Foundation planting including shrubs and other ornamental plantings located immediately in front of houses is permissible.
- (f) Mature tree canopies should be maintained, restored or enhanced in accordance with Section 3.5.6 Tree Canopy.
- (g) Tree planting within a mature tree canopy should be selected in accordance with Section 3.5.6 Tree Canopy.

TYPES OF LANDSCAPE FILTERS AND SCREENS

A) Landscaped Berm

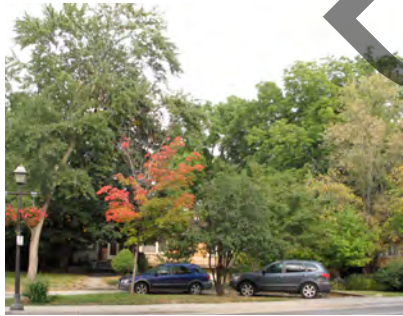
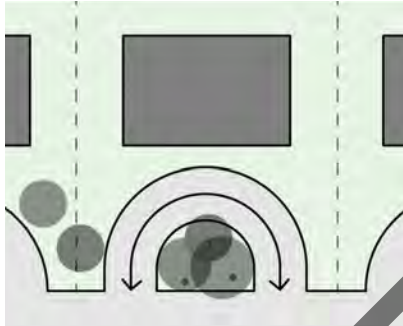

Figure 71. Example of landscaped berm at 70 Main Street South. (Source: ERA)

B) Scattered trees in front yard

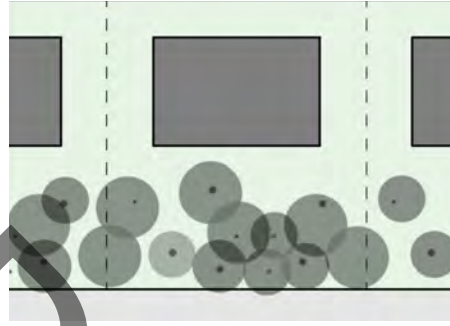

Figure 72. Example of scattered trees as a landscaped filter at 76 Main Street South. (Source: ERA)

C) Hedges and fences as screens

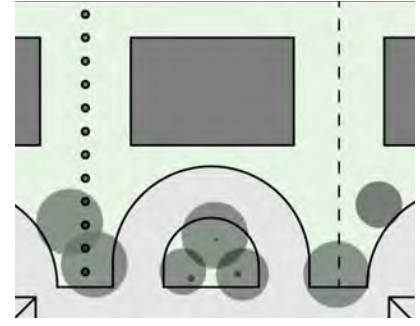

Figure 73. Examples of hedge rows and decorative metal fences as screens between properties within the District. (Source: ERA)

3.5.4 FENCING

- (a) Do not use chain-link fences, solid wood stockade fences or block walls in areas visible from Main Street South.
- (b) Use historic fence types. Such as wrought iron, wood pickets or wood pickets, in front yards with an open appearance and a scale that relates to the main building.
- (c) Where appropriate, fences in the front yard should be no more than 1 metre high. This height should be maintained along the side yard as far as necessary to provide an unobstructed view to the front façade of the house. At that point, the fence may become gradually higher and less open.

DRAFT



Figure 74. Stone retaining walls on the west side of at 77 Main Street South. (Source: ERA)



Figure 75. Metal entry posts at 78 Main Street South. (Source: ERA)



Figure 76. Light fixture atop stone column base at 73 Main Street South help block views of parking and also delineate the entrance of the site. (Source: ERA)



Figure 77. Stone pavers at 68 Main Street South provide a texture to the landscape design. (Source: ERA)

3.5.5 DECORATIVE LANDSCAPE ELEMENTS

- (a) Use of high quality materials, such as natural stone, wood, and metal, in decorative landscape elements is encouraged.
- (b) Front yard landscaping is to utilize high quality design and materials.
- (c) Decorative elements, should be placed in accordance with the overall character of a site. Landscape elements should serve to enhance the design of the landscape and buildings. This may include but is not limited to framing the main building, marking an arrival point or walkway, integrating grading or natural features, or adding a focal point to a site.

3.5.6 TREE CANOPY

(a) The tree canopy in the District is a significant attribute that reflects the age and overall heritage value of the area. With many trees in the District reaching maturity, it is recommended that a tree protection and replacement strategy be developed.

(b) Trees that have a diameter of 40cm or greater are protected under the City of Brampton's Tree Preservation By-Law. However, in the spirit of preserving and maintaining a heritage streetscape, a more rigorous Tree Management Program should be considered for the Main Street South District. For example, other jurisdictions within the Greater Toronto Area have similar tree preservation by-laws, but use a range of standards from 15cm to 30cm diameters.

(c) It is recommended that the City of Brampton document, catalogue and inventory trees (including drawings, maps, and photos) and conduct a vegetation assessment in order to develop a tree canopy maintenance strategy and replacement program that would support the heritage character of the District.



Figure 78. Early photograph of 52, 56, 58 Main Street South showing the tree canopy on deep lots is vital to the park-like character of the District. Date unknown. (Source: City of Brampton)



Figure 79. Early photograph of tree-lined Main Street South. Date unknown. (Source: City of Brampton)



Figure 80. Existing measures maintain the tree canopy with new saplings in Gage Park in front of 7 Wellington Street. (Source: City of Brampton)

- (d) Any proposed change or development that would harm mature trees is discouraged.
- (e) Any construction on private land or required for public works that could impact the root zones of the existing mature street trees should be executed under the supervision of municipal forestry staff, or outside consultants, such as certified arborists or registered foresters, with the opportunity to review engineering plans and provide tree preservation/protection measures.
- (f) If a tree appears to be in poor health, severely damaged or in serious need of major pruning, contact the City of Brampton Forestry Division for advice or assistance.
- (g) New 60-70mm caliper trees of native species are encouraged in order to support the tree canopy and ensure its future health. They should be dispersed to allow enough space to grow to full maturity (refer to the City of Brampton Deciduous and Coniferous Tree Planting Details #910 and #911).

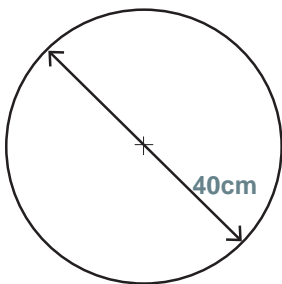

Figure 81. Currently protected under the Tree Preservation By-Law. (Source: ERA)

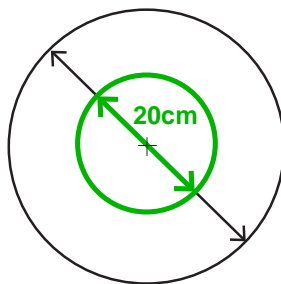

Figure 82. Proposed restriction for trees within the District. (Source: ERA)

- (h) Planting of infill trees should maintain the tree-lined boulevard character of the streetscape by maintaining the canopy structure over Main Street South.
- (i) Spacing of infill trees should maintain the park-like character of the District by maintaining visual transparency between tree trunks from the streetscape to houses.
- (j) Replacement trees should include a variety of native species, so as to avoid mono culture planting. Native species, among others, include: sugar maple, red maple, red oak, white oak, eastern white pine, basswood.
- (k) Other tree varieties that are found regionally and have proven to be appropriate and well adapted to the local soil and climate conditions also exist. For further advice and guidance regarding appropriate species and existing procedures governing the installation of plant material and trees, please contact the Urban Forester at the City of Brampton Forestry Division or a professional arborist.

VIEW OF THE DISTRICT'S TREE CANOPY



Figure 83. Native species in the District including sugar and silver maples, red and white oaks, eastern white pine, white spruce contributing to a full tree canopy, as is shown above in this photograph of Main Street South. (Source: City of Brampton)



Figure 84. The mature tree canopy is a significant character defining attribute of the District. (Source: City of Brampton)

3.5.7 PUBLIC REALM

- (a) Avoid widening the roadway.
- (b) The mature tree canopy along Main Street South is a significant heritage attribute of the District. The widening of the roadway since the diversion of Etobicoke Creek has already encroached upon the existing street tree canopy. Any further widening of the right-of-way would require the removal or injury of several mature trees, harming this important attribute of the District.
- (c) New public works should allow the tree canopy to be conserved or enhanced.
- (d) Ensure that the installation of public works, including transit infrastructure and utilities, does not interfere with the heritage attributes of the District, such as significant trees, walkways and other landscape elements.
- (e) Introduction of transportation infrastructure should be implemented within the existing roadway width to avoid reduction of the existing tree canopy.
- (f) Transit shelters and waiting areas should be designed in a way that will conserve the character of the district, by means of minimizing impact on the tree canopy, respecting existing patterns of grading and topography, and respecting views of contributing heritage buildings. The size, design and location of shelters can also contribute to conserving the District's character.
- (g) For street lighting, maintain the regular placing of iron lamp posts, ornamented with hanging flower pots, as they provide uniformity.
- (h) Any addition of street furniture should be sympathetic to the heritage character of the district. Street furniture should be built of high-quality materials and should avoid the use of plastics.

- (i) New furniture should provide continuity with existing street furniture and other streetscape improvements, such as the coach light lanterns.
- (j) Above ground utilities should be designed to minimize their visibility from the street through screening, placement, or other appropriate measures, with the objective of conserving the character of the District.
- (k) Signage must be designed to conserve the character of the District.
- (l) Signage must be reviewed to consider possible impacts on the character of the District.
- (m) Large-scale signage is strongly discouraged.
- (n) The remains of the retaining wall and bridge posts at the front lawns of 52, 56, and 58 Main Street South provide important physical evidence of the historic character of the District prior to the diversion of the Etobicoke Creek. These fragments should be used as part of a future heritage interpretation program.



Figure 85. Widening of the roadway has encroached on this tree's root system. (Source: ERA)



Figure 86. Installation of public utilities on Main Street South impact the heritage character of the streetscape. (Source: ERA)



Figure 87. Coach lanterns with hanging flower pots contribute to the streetscape character of the District. (Source: ERA)

3.6 LOT SEVERANCE

This section provides a guidance for lot severance within the District. The Downtown Secondary Plan (SPA 7 Policy 5.6.1.1 (iii)), discourages subdivision of existing lots fronting on Main Street South. Retaining the existing lot patterns in the District will help conserve the parklike setting, established by generous side yards, deep lot depths, and large setbacks. Therefore, the severance of lots must not alter historic lot size patterns established by the 1854 Guest Plan, 1873 Jones Plan, and the estate like lots near the former Etobicoke Creek alignment.

Applications for severance or minor variance through the Committee of Adjustment relate to land use planning matters rather than construction and demolition, per se. As such, they do not require Heritage Permits under the Ontario Heritage Act. In reviewing applications, the Committee of Adjustment consults with appropriate City departments and agencies regarding adjacent use (i.e. compatibility of the size, shape, and proposed use of the new lot with the adjacent lots), access considerations, and availability of services. Consideration is also given to maintaining desirable development patterns of established residential neighbourhoods, and avoiding the perpetuation of undesirable patterns of development (e.g. regularized patterns typical of subdivision development).

When commenting to the Committee of Adjustment on applications for severance or minor variance in the District, the City should only support such applications if the proposal is compatible with the objectives and policies of the District Plan.

Each severance and minor variance will be evaluated on a case-by-case basis in accordance with City of Brampton Official Plan, Downtown Brampton Secondary Plan, and the objectives and policies of the District Plan. It is incumbent upon the applicant to demonstrate to the satisfaction of City Staff how the application meets the below listed criteria. City Staff will evaluate applications, taking into account the following criteria, where applicable.

- (a) Corner lots must have sufficient lot width and depth and are only to be severed when the new resulting lot would provide access along a secondary street (i.e. not Main Street South).
- (b) Similarly, mid-block lots must have sufficient lot depth and are only to be severed when the new resulting lots would provide access along a secondary street, namely Elizabeth Street South, Fredrick Street, Harold Street, Wellington Street West, Etobicoke Drive, Clarence Street, and Guest Street.
- (c) The severance must be setback an appropriate distance from the rear façade of the primary structure on the original lot.
- (d) Historic laneways accessed from Elizabeth Street South must be conserved in existing conditions, and must not be upgraded, for instance paving, widening, and curbs.
- (e) No new public or private roads will be permitted to facilitate the severance.
- (f) New buildings and accessory structures shall be sited to best reduce visibility of the structure from Main Street South, or shall be adequately screened.
- (g) The severance and resulting new construction must not harm mature trees within the new and retained lots.
- (h) Where severance occurs on a lot that provides access to both Main Street South and a secondary public street, the retained lands must forfeit the secondary access to a public street.

PLANS AND SECTIONS OF MAIN STREET SOUTH, BEFORE AND AFTER THE ETOBICOKE CREEK DIVERSION

1945



Figure 88. Main Street South roadway in 1945, looking south. (Source: ERA)

2014



Figure 89. Current Main Street South roadway, looking south. (Source: ERA)

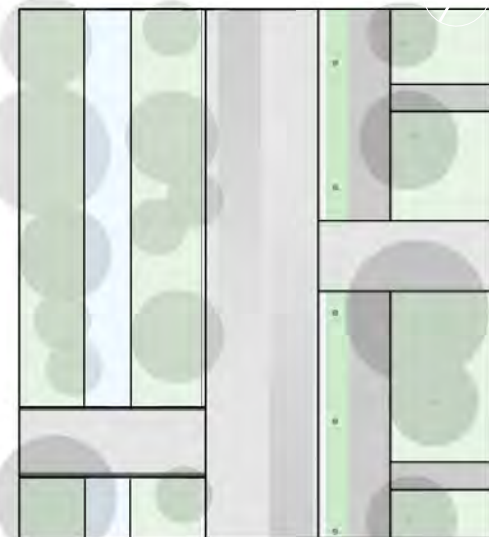
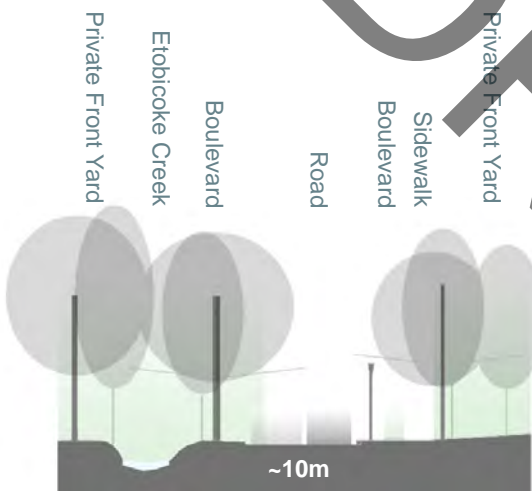

Figure 90. Illustration of streetscape segment 1945. (Source: ERA)

DRAFT

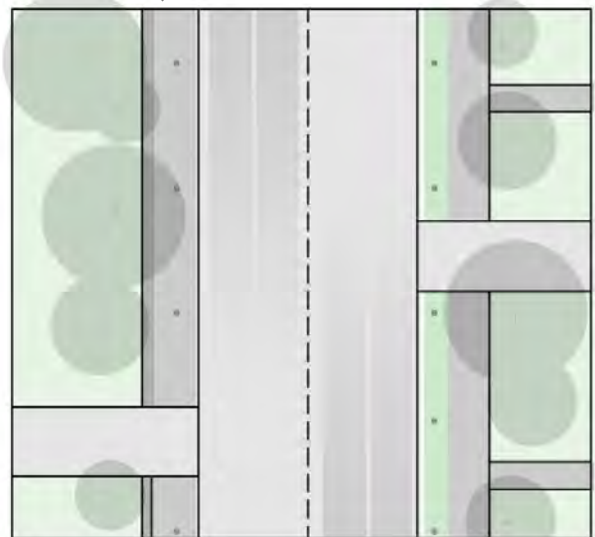
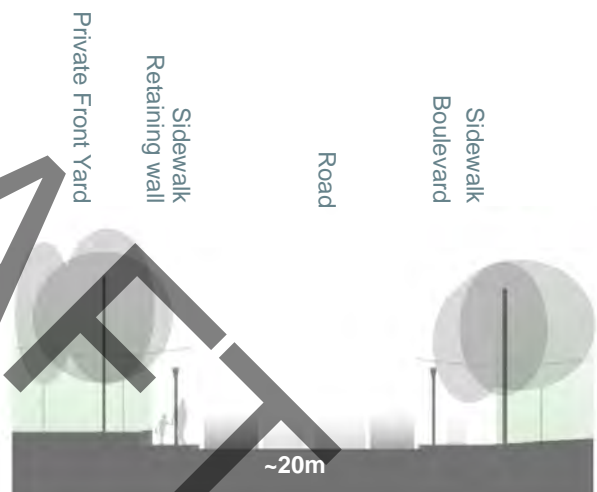

Figure 91. Illustration of streetscape segment 2014. (Source: ERA)

REMNANTS OF THE ETOBICOKE CREEK DIVERSION



Figure 92. Driveway bridge from street to 58 Main Street South. (Source: City of Brampton)



Figure 93. Remaining bridge posts. (Source: ERA)



Figure 94. Remaining retaining wall. (Source: ERA)

3.7 GENERAL MAINTENANCE GUIDELINES

Heritage properties just as non-heritage properties naturally deteriorate over time, therefore in order to prevent this degradation every property calls for a minimum amount of upkeep. Routine inspections are useful in identifying problems at an early stage, this in hand with proper repairs will prolong the life of the property. Typically, this is also beneficial as it can help avoid the need for major repairs when minor problems are allowed to persist. Problems that are unattended or improperly repaired have the potential to adversely effect the heritage attributes of the property.

The remainder of this section provides general maintenance guidelines and links to useful resources that describe in detail how heritage properties are best maintained.

- (a) Maintenance and repairs should aim at prolonging the usability and aesthetic value of the building, especially when such structures are consistent with the age and style of the main building.
- (b) Conduct routine inspections of buildings and develop a maintenance plan to ensure deterioration, damage or weathering is addressed at an early stage.
- (c) Property owners are encouraged to develop a regular maintenance plan.
- (d) Clean materials only when necessary to remove heavy soiling. Cleaning methods should be as gentle as possible to obtain satisfactory results. Cleaning should be carried out only after it has been determined that a specific cleaning method is appropriate.
- (e) Simple maintenance can greatly extend the service life of property elements. For instance, maintaining the roof by addressing damage and deterioration. More specifically, the first step would be to protect

and maintain a roof by cleaning the gutters, downspouts, rainwater leaders and replacing deteriorated flashing.

- (f) Be sure to identify the root of any identified problem, rather than merely remedy the symptoms.
- (g) Undertake regular maintenance, such as re-pointing brick and/or stone masonry, to extend the life of the original building fabric.
- (h) When cleaning masonry, use only recognized preservation methods and products. Avoid abrasive treatments or strong chemical reactions with the masonry surface, or excessively high-pressure washes that could lead to significant water penetration into mortar and damage other masonry surfaces.
- (i) Limit the cleaning of masonry surfaces to the removal of heavy surface soiling or graffiti and where such cleaning may help to stop masonry damage (such as by removing mold and lichens).

Additional Online Resources Regarding Maintenance of Heritage Properties



Manitoba Heritage Building Maintenance Manual.

https://www.gov.mb.ca/chc/hrb/pdf/maintenace_for_heritage_bldgs.pdf

The Standards and Guidelines for the Conservation of Historic Places in Canada

<http://www.historicplaces.ca/en/pages/standards-normes.aspx>

National Park Service Preservation Briefs, most notably Preservation Brief 47: Maintaining the Exterior of Small and Medium Size Historic Buildings

<http://www.nps.gov/tps/how-to-preserve/briefs/47-maintaining-exteriors.htm>

Well-Preserved: The Ontario Heritage Foundation's Manual of Principles and Practice for Architectural Conservation by Mark Fram

<http://www.heritagetrust.on.ca/Resources-and-Learning/Free-publications/Well-Preserved.aspx>

(Source: Manitoba Culture, Heritage, Tourism)

3.8 DEMOLITION

The District Plan emphasizes restoration over replacement. Nevertheless, the opportunity for change and new development within the District is recognized. Demolition is discouraged, however it is acknowledged that the impact of demolition can vary depending on the heritage value of the building in question and the design value of the proposed replacement building.

- (a) For Contributing Buildings: Applications for demolition will be refused except under extraordinary circumstances, such as structural instability or dereliction where the building is deemed to be beyond restoration as determined by a qualified engineer.

The replacement building must contribute to the heritage value of the District and comply with the District Guidelines and other applicable municipal policies.

- (b) For Non-contributing Buildings: Demolition of a non-contributing building is generally permissible if the replacement building contributes to the heritage value of the District and is acceptable under the District Guidelines and other applicable municipal policies.

Note: A Heritage Impact Assessment will be required as part of all demolition permit applications for contributing buildings. A Heritage Impact Assessment may also be required for new construction in the District, at the discretion of City of Brampton Heritage staff.

4.0 PROCEDURES

4.1 DESIGNATION

In designating the Main Street South Heritage Conservation District, City Council takes the following actions:

- » The Main Street South Conservation District, with boundaries as illustrated in this Plan, is designated by by-law as a Heritage Conservation District under Part V of the Ontario Heritage Act.
- » All individual properties within the District are added to the City of Brampton's 'Municipal Register of Cultural Heritage Resources Designated Under the Ontario Heritage Act'.
- » The District Plan is adopted by by-law to guide change in the District.
- » A Heritage Permit process is established for alterations within the District.

4.2 CONSISTENCY WITH HERITAGE CONSERVATION DISTRICT PLAN

Sub-sections 41.2(1) and 41.2(2) of the Ontario Heritage Act require that municipal by-laws and public works to be consistent with the Heritage Conservation District Plan. The Act states the following:

41.2(1) [I]f a heritage conservation district plan is in effect in a municipality, the council of the municipality shall not,

(a) carry out any public work in the district that is contrary to the objectives set out in the plan; or

(b) pass a by-law for any purpose that is contrary to the objectives set out in the plan.

41.2(2) In the event of a conflict between a heritage conservation district plan and a municipal by-law that affects the designated district, the plan prevails to the extent of the conflict, but in all other respects the by-law remains in full force.

When implementing the District Plan, its provisions are integrated into the landuse planning framework of the City of Brampton. Any potential conflicts or inconsistencies within this planning framework must be revised to comply with the Plan.

4.3 HERITAGE PERMIT PROCESS

4.3.1 WHAT IS A HERITAGE PERMIT?

A Heritage Permit is a certificate issued by the City of Brampton for exterior alterations that may affect the cultural heritage value and attributes of the District.

The Heritage Permit process enables the City to: monitor the conservation of the District and manage changes within it; to ensure work conserves the District's cultural heritage value and attributes; and supports the objectives of the District Plan. There is no fee for the Heritage Permit process.

The legal basis for a heritage permit is found in the Ontario Heritage Act and Brampton's Official Plan.

The Ontario Heritage Act (Section 42) states:

42. (1) No owner of property situated in a heritage conservation district that has been designated by a municipality under this Part shall do any of the following, unless the owner obtains a permit from the municipality to do so:

- 1. Alter, or permit the alteration of, any part of the property, other than the interior of any structure or building on the property.*
- 2. Erect, demolish or remove any building or structure on the property or permit the erection, demolition or removal of such a building or structure. 2005, c. 6, s. 32 (1).*

Section 4.9.3 of the Brampton Official Plan regarding heritage conservation districts states:

4.9.3.10 A permit is required for all alteration works for properties located in the designated Heritage Conservation District. The exceptions are interior works and minor changes that are specified in the Plan.

*4.9.3.11 The permit application shall include a Heritage Impact Assessment and provide such information as specified by the City***

**Clause 4.9.3.11 should be amended to replace the word “shall” with “may”, in order to limit the requirement for Heritage Impact Assessments to those projects that are major in nature and have significant impacts on the individual property and/or the District.

4.3.2 WHEN IS A HERITAGE PERMIT REQUIRED?

In the most general sense, a Heritage Permit is required prior to any alteration likely to result in the loss, removal, obstruction, replacement, damage or destruction of one or more heritage attributes on a property designated under Part IV of the Ontario Heritage Act or contained within a Heritage Conservation District designated under Part V of the Ontario Heritage Act.

As a rule of thumb, a Heritage Permit is required for any large-scale exterior alterations and additions; essentially any works that would also require a Building Permit, Demolition Permit or other formal approvals by the City, conservation authorities and/or other agencies and other levels of government.

A Heritage Permit may also be required for some smaller scale projects (e.g. replacing a front door, removing verandah railings, etc), if that project would impact existing heritage attributes and features.

The Heritage Permit process applies to the entire property and all exterior elevations - not just to the front facade.

Heritage permits should be retained prior to seeking any other final approvals, such as Minor Variances from the Committee of Adjustment, Site Plan approvals, etc.

4.3.3 TYPICAL PROJECTS THAT DO REQUIRE A HERITAGE PERMIT

- » New Construction: such as new buildings, additions, introducing new exterior architectural detailing and finishes, along with new garages, fences, barns, outbuildings, porches, verandahs, steps and decks;
- » Major Structural Alterations and Rehabilitation Projects: such as replacement, removal and changes to existing porches, verandahs, windows and window openings, doors and door openings, chimneys, awnings, existing millwork, decorative elements, detailing and finishes, foundations, barns, outbuildings and the like;
- » Major Changes to Exterior Walls and Cladding: such as introduction or removal of soffits, fascia, vinyl siding, stucco finishes; painting previously unpainted masonry walls or removing paint from painted masonry walls; repointing masonry, replacing bricks, repairing or replacing stone finishes, parging foundation walls, removing key wall features such as lintels, sills, parapets, chimneys, quoins, voussoirs, and the like;
- » Major Landscaping: such as removal of mature trees, erection of fences, grading, installation of new paths, parking areas and laneways, altering or removing historic outbuildings and the like;
- » New Signage;
- » Historical Restoration Projects: such as restoration or replication of original or vintage elements including verandahs, millwork, finishes and the like;
- » Any other larger scale exterior alterations or structural repairs that are likely to affect existing heritage attributes.
- » Demolition of buildings and structures.

4.3.4 TYPICAL PROJECTS THAT DO NOT REQUIRE A HERITAGE PERMIT:

A Heritage Permit is typically not required for regular or routine maintenance and other day-to-day activities.

Generally, if work does not affect heritage attributes/character defining elements of a property or the District, it may be considered a “minor changes/alterations” and will not require a Heritage Permit.

Examples of work that does not require a Heritage Permit include:

- » Minor repairs, using the same materials and profiles, of existing exterior features including windows, doors, eaves troughs, fences, foundations, roofing, railings, and steps;
- » New roof shingles using the same materials;
- » Weather-stripping and insulating;
- » Interior work provided that it does not impact the exterior or interior elements included in the scope of heritage designation;
- » Exterior painting of wood, stucco or metal finishes;
- » Construction of backyard patios, tool sheds, other small outbuildings if they are to be located at the rear of the property and/or if not readily visible from the street or other public areas;
- » Gardening and minor landscaping;
- » Structural repairs that do not affect the exterior or overall structural integrity of the building.

Contact a City of Brampton Heritage Coordinator to determine if the proposed work requires a heritage permit.

4.3.5 ADMINISTRATION OF HERITAGE PERMITS

All heritage permit applications are administered by City of Brampton Heritage staff. Authority to approve a permit rests with the City Council. If City Council refuses the permit or grants the permit with terms and conditions attached, the owner of the property may appeal to the Ontario Municipal Board, a provincial-level tribunal.

4.3.6 OTHER APPROVALS

Obtaining a heritage permit does not include a review or relief from any other approvals or regulations.

Properties in the District are subject to standard regulations, such as building permits. The applicant or property owner is responsible for identifying what other permits or approvals are required prior to carrying out any work.

4.3.7 HERITAGE PERMIT APPLICATION SUBMISSION REQUIREMENTS

Depending on the scope of work proposed a Heritage Permit Application may require the following:

- » Drawings / Plans - Should be folded to 8.5 x 11" paper size, if possible, and measured in metric scale.
- » Photographs - In colour and labelled showing the existing building and neighbouring buildings or streetscapes; photographs of the specific area(s) being altered.
- » Registered Survey - Prepared by a licensed Ontario Land Surveyor and up to date. All existing easements and right-of-ways should be shown.
- » Site Plans – Showing existing and proposed structure(s)/ addition(s) on the lot, setbacks from front, rear and side lot lines, proposed demolition of existing site features, and location of proposed site features such as accessory structures, parking spaces, driveways, walls, gates, fences, trees, retaining walls, hydro poles, and fire hydrants.

- » Building Elevations – Showing all elevations of the proposed addition(s)/alteration(s). Details to include building height, existing and proposed grade, finished floor elevations, window and door openings, roof slopes, building materials, location and type of outdoor lighting fixtures, railings, design/location of signage, down spouts, balconies, porches, landings, and stairs.
- » Floor Plans – Depicting the arrangement of interior spaces, including the existing and proposed location of walls, windows and doors. All rooms should be labelled as to use, with dimensions on each floor plan in metric scale.
- » Material Specifications – Samples, brochures, etc. of proposed materials, finishes and colours.
- » Certified Arborist Report – for the removal of trees larger than 20 cm caliper measured at 1.37 metres height from the ground.
- » Heritage Impact Assessment – For larger scale projects, such as major additions, new construction, and demolition.
- » Completing the application form in full and providing all of the required information/ documentation will expedite the approvals process. An incomplete application cannot be processed and the official notice of receipt (as required under the Ontario Heritage Act) will not be issued until all of the documents have been submitted and the application is complete.
- » The submission of electronic copies of drawings and photos, in addition to hard copies, is encouraged.

Before you begin to formulate plans for changes to your property, review the District Plan and contact City Heritage staff.

4.3.8 HOW TO APPLY FOR A HERITAGE PERMIT?

1. Review the District Plan

2. Meet with City Heritage Staff

Contact with City of Brampton Heritage Coordinator to discuss the proposal at the early stages, when the proposed work is being planned.

The Heritage Coordinator can help ensure the proposed work conforms to the District Plan and can determine whether a Heritage Permit is required.

3. Submit a Heritage Permit Application

Obtain a Heritage Permit application form and package.

Consult with a City of Brampton Heritage Coordinator to discuss the project scope prior to submission and confirm which information and materials need to be included in the application.

Complete the form, provide required information and materials, and submit the application to City Heritage staff.

4. Heritage Permit Approval Process

The Heritage Coordinator will circulate the Heritage Permit Application to other City departments for review and comment.

Staff prepare comments for consideration by the Brampton Heritage Board and Council. Staff support will be contingent upon applications demonstrating a clear understanding of and a sensitive response to the District, and compliance with the District Plan.

Heritage Permit application and the staff's comments will be passed to Brampton Heritage Board for consideration.

Brampton Heritage Board will consider the application and staff's comments at a scheduled meeting. The Brampton Heritage Board can either advise City Council by recommending approval with or without conditions, or refusal.

Planning & Infrastructure Services Committee next reviews the application, staff recommendations, and Brampton Heritage Board motion. The Committee's recommendation is passed on to City Council.

City Council makes a decision to approve, approve with amendments, or decline your Heritage Permit application.

If Council approves the Permit, the City Clerk's Department issues correspondence and the heritage permit is prepared by Heritage staff and issued to the applicant. A copy of the Permit is also circulated to the Building Division.

5. Appeal to the Ontario Municipal Board (optional, if permit is refused or if approved with conditions)

In the event that Council refuses the Heritage Permit, or approves the Permit with conditions, the applicant can choose to appeal the refusal or conditions to the Ontario Municipal Board. The Ontario Heritage Act defines this appeal process.

4.3.9 HOW LONG DOES THE PERMIT REVIEW PROCESS TAKE?

The Ontario Heritage Act is very specific on this point. Once a complete permit application is received, the City is to "cause a notice of receipt to be served on the applicant". Council must then make its decision regarding the merits of an application within 90 days. If mutually agreed upon, an extension can be granted.

If the applicant does not hear back after the 90-day period expires Council shall be deemed to have consented to the application. Although the standard procedure would be for the City to notify the applicant of Council's decision.

HERITAGE PERMIT PROCESS

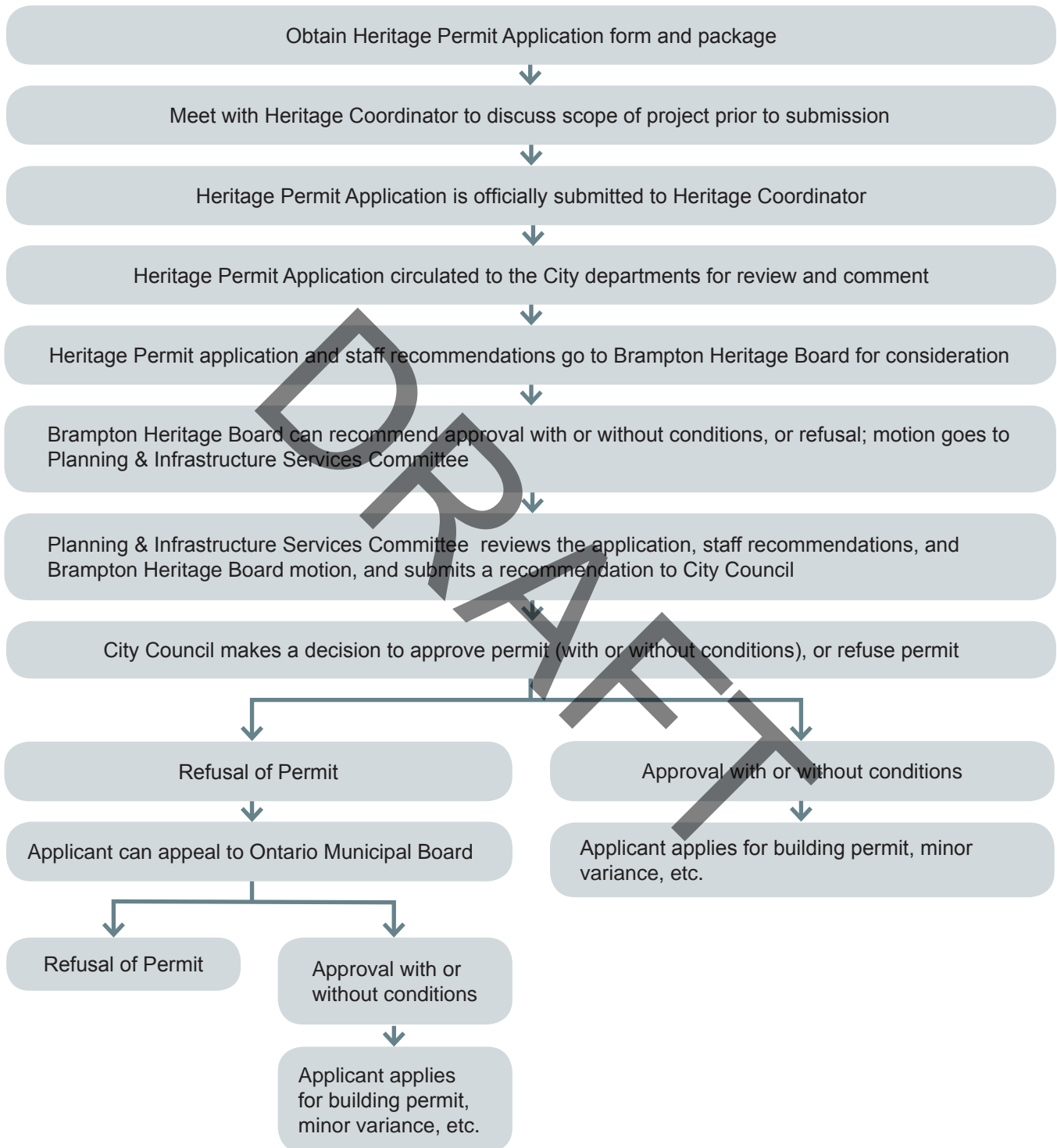

Figure 95. Diagram of Heritage Permit Process. (Source: ERA, adapted from City of Brampton)

4.4 PROPERTIES DESIGNATED UNDER PART IV OF THE ONTARIO HERITAGE ACT

Some properties in the District were designated as cultural heritage resources before the District was established. These properties, designated under Part IV of the Ontario Heritage Act, will continue to be protected in the same as they were prior to the establishment of the District. When reviewing applications for alterations to these properties, the City will consider the description of cultural heritage value and heritage attributes identified in the Part IV designation by, as well as the District Plan guidelines .

4.5 DEVELOPMENT ADJACENT TO THE HERITAGE CONSERVATION DISTRICT

The cultural heritage and archaeological resource policies of the Provincial Policy Statement (2014) of the Ontario Planning Act addresses the potential impact(s) of development on lands adjacent to heritage property.

In the case of the Main Street South Heritage Conservation District, any development proposals outside but adjacent to the District boundary must comply with Section 2.6.3 of the Provincial Policy Statement (2014) and consider the Statement of Objectives and Design Guidelines contained within this Plan.

4.6 DESIGNATED HERITAGE PROPERTY INCENTIVE GRANT PROGRAM

Properties designated under the Ontario Heritage Act are eligible for the “Designated Heritage Property Incentive Grant Program”.

The grant is intended to encourage and assist with the preservation, maintenance and restoration of designated properties. The grant offers funds to cover half of the cost of eligible conservation work up to a maximum of \$5,000, subject to available funding, on the condition that the grant is matched by the property owner.

Projects must focus on the care and rehabilitation of existing heritage attributes or restoration that contributes to the cultural heritage value of the property and District.

4.7 LOCAL HERITAGE ADVISORY COMMITTEE

If a local advisory committee is established for the Main Street South Heritage Conservation District, it can provide recommendations to the Brampton Heritage Board and City Council regarding Heritage Permit applications within the District. All proposed public works and planning applications (including minor variances and consents) affecting lands within the Heritage Conservation District or adjacent to it will be circulated to the advisory committee.

4.8 FIVE YEAR REVIEW

Periodic reviews of the Main Street South Heritage Conservation District will be undertaken to: evaluate the effectiveness of the District guidelines; ensure consistency among relevant City policies; and update the building inventory of contributing and non-contributing properties.

Maintaining an inventory of Heritage Permit applications will create a record of alterations to properties in the District. This inventory will inform the District Plan five-year review and how change is managed in keeping with the Plan's objectives.

4.9 DELEGATION OF AUTHORITY:

The City of Brampton Delegation of Authority By-law 191-2011, as amended, enables staff to issue Heritage Permits for alterations under certain circumstances on Council's behalf, including:

- During periods when meetings are not normally scheduled and the 90 day expiry date may be overrun;
- Emergency permits;
- Projects that are of a minor nature or are alterations to non-heritage features of a property; and,
- Alterations to interior heritage attributes in private residences.

Refer to By-law 191-2011 for further details regarding the circumstances under which the delegated authority may be exercised. If staff determine that the Heritage Permit application does not meet the requirements for a delegated authority as set out in the by-law, the application will undergo the full Heritage permit application process.

5.0 BIBLIOGRAPHY

City of Brampton. Brampton's 100th Anniversary 1873-1973. Brampton: Charters Publishing, 1973.

City of Brampton. A Walk Through Time, Downtown Heritage Walking Tour.

City of Brampton. Municipal Register of Cultural Heritage Resources Designated Under Parts IV and V of the Ontario Heritage Act.

City of Brampton. Municipal Register of Cultural Heritage Resources "Heritage Listing".

City of Brampton Official Plan, 2006.

The Conservator, Volume 78, Number 32, Supplement, Thursday July 3, 1952.

Downtown Urban Design Vision Study. City of Brampton, Planning Design and Development. September 2005.

Heritage Conservation District Feasibility Study, For the Establishment of Heritage Conservation Districts in Downtown Brampton. George Robb Architect Team. March 23, 2009.

Loverseed, Helga. Brampton, An Illustrated History. Burlington, Ontario: Windsor Publications (Canada) Ltd. 1987.

Rees, Ray. Brampton, Ontario; An Urban Study. 1960. Thesis (M.A.) University of Toronto, 1960.

6.0 APPENDICES

APPENDIX 1: STATEMENTS OF CONTRIBUTION FOR CONTRIBUTING BUILDINGS AND LANDSCAPES OF INTEREST

APPENDIX 2: ARCHITECTURAL STYLE GUIDE MAIN STREET SOUTH HERITAGE CONSERVATION DISTRICT



APPENDIX 1: STATEMENTS OF CONTRIBUTION FOR CONTRIBUTING BUILDINGS AND LANDSCAPES OF INTEREST

Appendix 1 of the Main Street South Heritage
Conservation District Plan

JANUARY 2016

ERA

LIST OF CONTRIBUTING PROPERTIES

West Side	Contributing Building	Landscape of Interest	East Side	Contributing Building	Landscape of Interest
7 Wellington St.	✓	✓	52 Main St S	✓	✓
45 Main St S	✗	✓	56 Main St S	✓	✓
47 Main St S	✓	✓	58 Main St S	✓	✓
40 Elizabeth St	✓	✓	62 Main St S	✗	✓
59 Main St S	✓	✓	66A Main St S	✓	✗
61 Main St S	✓	✓	68 Main St S	✓	✓
63 Main St S	✓	✓	70 Main St S	✗	✓
65 Main St S	✗	✓	72 Main St S	✓	✓
67 Main St S	✓	✓	74 Main St S	✗	✓
71 Main St S	✗	✓	76 Main St S	✓	✓
73 Main St S	✓	✓	78 Main St S	✓	✓
75 Main St S	✓	✓	82 Main St S	✓	✓
77 Main St S	✓	✓	84 Main St S	✓	✓
79 Main St S	✓	✓	86 Main St S	✓	✓
83 Main St S	✓	✓	88 Main St S	Not Contributing	
89 Main St S	Not Contributing		90 Main St S	Not Contributing	
93 Main St S	✓	✓	96 Main St S	✓	✗
97 Main St S	✗	✓	98 Main St S	✗	✓
105 Main St S	✓	✓	102 Main St S	✓	✓
107 Main St S	✓	✓	108 Main St S	✓	✓
115 Main St S	✗	✓	13 Clarence St	Not Contributing	
117 Main St S	✓	✓	114 Main St S	✓	✓
119 Main St S	✓	✓	116 Main St S	Not Contributing	
127 Main St S	✓	✓	118 Main St S	✓	✓
133 Main St S	✓	✓	6 Etobicoke Dr	✓	✓
133A Main St S	Not Contributing		122 Main St S	Not Contributing	
			130 Main St S	Not Contributing	
			132 Main St S	✗	✓
			136 Main St S	✗	✓
			140 Main St S	✓	✓
			144 Main St S	✓	✓

MAP OF CONTRIBUTING PROPERTIES

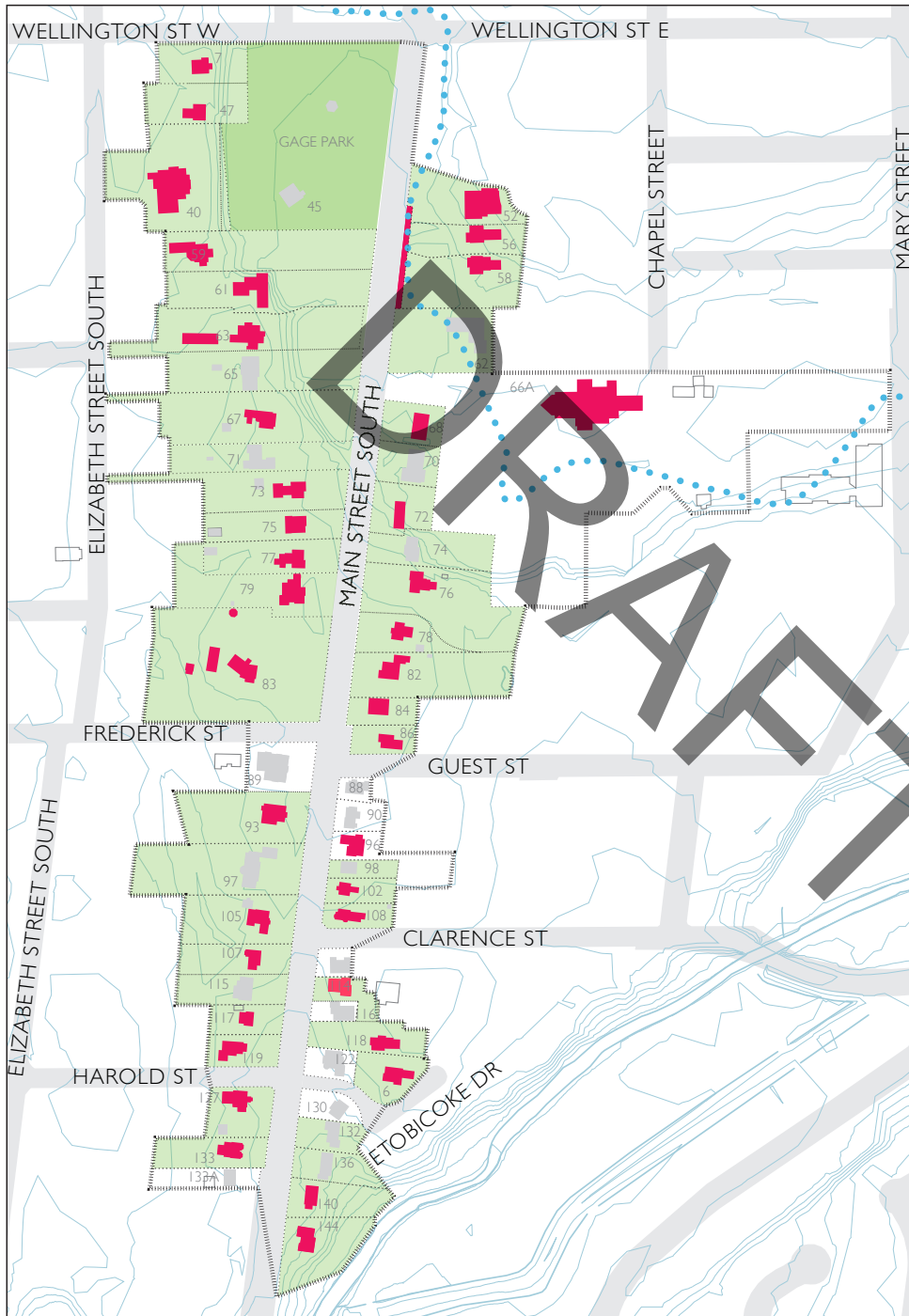

LEGEND

- Contributing Building
- Contributing Landscape of Interest
- Non-contributing Building

Map of Contributing Properties.
(Source: ERA)

WEST SIDE

DRAFT

7 WELLINGTON STREET WEST



STATEMENT OF CONTRIBUTION

This modest building contributes to the collection of small-scale homes found within the District. Its siting, raised above street level, further contributes to the District. While elements such as windows appear to be later interventions, the general form of the building and some exterior materials appear to be original. The flemish bond brick of the exterior is a key stylistic feature of the design.

According to the Listing Candidate Summary Report (2012), the property has design, associative, and contextual value. It serves as an example of a California-style bungalow and the landscaped grounds help support the character of Main Street South and is complimentary to the abutting Gage Park.

For additional information see the above mentioned report.

Estimated Period of Construction	1924-1931
Style	Craftsman
Height (storeys)	1 1/2
Main Materials	Brick
Sub-district	A - Etobicoke Creek
Setting	Deep setback from street on a raised elevation behind Gage Park
Landscape	Mix of ground cover, shrubs, and lawn
Notable Architectural Features	Entrance at centre elevation, covered porch with columns, flemish bond brick, projecting bays on the side elevation, gable roof
Additional Information	

45 MAIN STREET SOUTH (GAGE PARK)

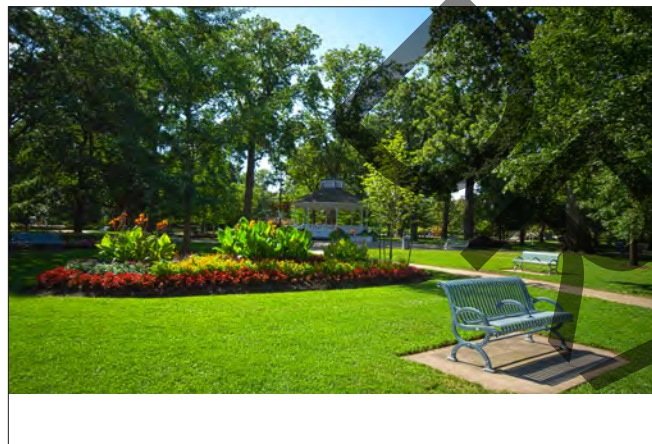
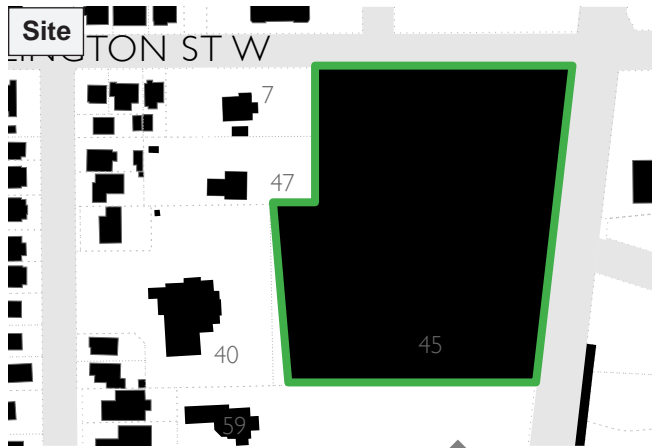

STATEMENT OF CONTRIBUTION (LANDSCAPE INTEREST ONLY)

Gage park is well defined open space within the District. Its designed landscape and tree cover enhance the character of the District.

Gage park has long been associated with the city’s civic life. It is Brampton’s first municipal park, established in 1903 after Sir William J. Gage donated land from an estate once owned by the prominent Chisholm family. The Chisholm estate house, called Alderlea, still stands on the west side the park at 40 Elizabeth Street and is also in the District.

The original terraces of the Kenneth estate lands survive as features of the park landscape.

Estimated Period of Construction	Not Applicable
Style	Not Applicable
Height (storeys)	Not Applicable
Main Materials	Not Applicable
Sub-district	A - Etobicoke Creek
Setting	
Landscape	Designed park, with open lawn, pathways, terracing, mature trees, and tree cover
Notable Architectural Features	Band stand, Bominion Bell, and Veterans Monument
Additional Information	

47 MAIN STREET SOUTH

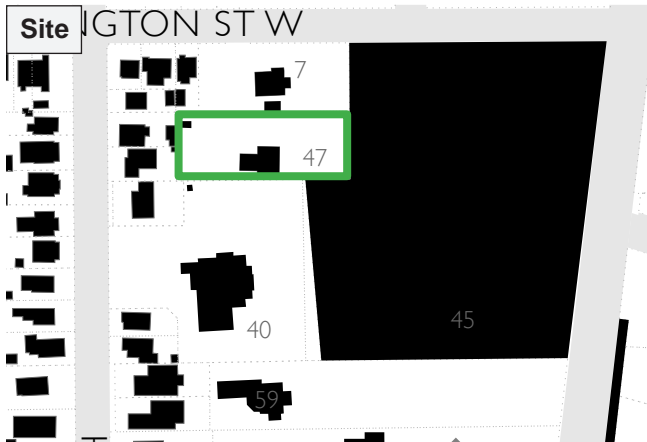

STATEMENT OF CONTRIBUTION

This handsome Georgian influenced home is sited on a rise of land set back from Main Street South and features, a symmetrical front façade, with a central entrance and multi-light windows, and a shallow hipped roof. The property also contains lawn terracing.

Estimated Period of Construction	1931-1940
Style	Georgian influence
Height (storeys)	2 1/2
Main Materials	Brick
Sub-district	A - Etobicoke Creek
Setting	Deep setback from street on raised elevation behind Gage Park
Landscape	Mix of open ground and tree cover with retaining wall at entrance, and lawn terracing
Notable Architectural Features	Symmetrical front elevation, windows on the second storey, first floor windows flanking the main entrance each window divided into four sections, and hipped roof
Additional Information	

40 ELIZABETH STREET (ALDERLEA)



Estimated Period of Construction	1865-70
Style	Italianate-style Victorian
Height (storeys)	3
Main Materials	Brick
Sub-district	A - Etobicoke Creek
Setting	Deep setback from the street, elevated over Gage Park
Landscape	Mix of hard and soft landscape with seating areas
Notable Architectural Features	Buff coloured brick exterior walls, a shallow hip roof with projecting eaves, brackets with turned droppendants, a prominent belvedere, a Venetian window, and a large verandah with balustrade columns
Additional Information	Designated under Part IV of the Ontario Heritage Act, By-law #281-2001

STATEMENT OF CONTRIBUTION

Built in 1867, Alderlea is an exceptionally well-preserved heritage resource and one of the finest examples of Italianate Villa architecture in Ontario. The architectural significance is enhanced by the general belief that the structure was designed by prominent architect William Kaufman.

The property also has historical or associative value as it is associated with Kenneth Chisholm, a member of the provincial legislature and a successful businessman.

The contextual value of Alderlea is related to its status as an architectural and historical landmark within Brampton. With its elevated position overlooking Gage Park, it continues to maintain and define the historic character of downtown Brampton.

Alderlea was purchased by the City of Brampton as part of its sesquicentennial, and has undergone restoration. Through adaptive reuse the property now functions as a special events centre.

Refer to Part IV designation by-law for additional information.

59 MAIN STREET SOUTH

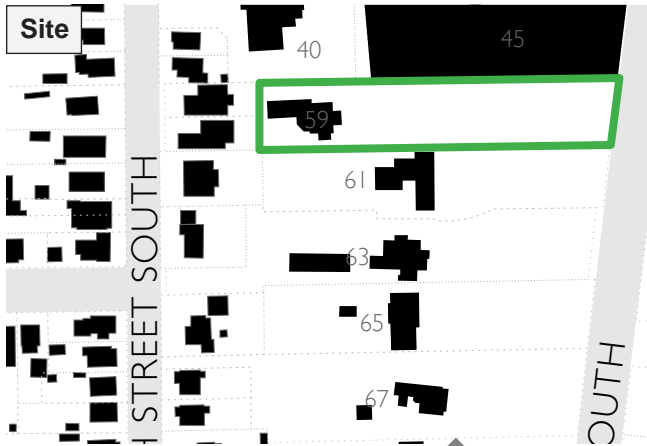

Source: PAMA

STATEMENT OF CONTRIBUTION

This large mid-to-late 19th century house sits back from Main Street, and contributes to the collection of estate-like houses in the District. Its design echoes old English estate houses through the use of a projecting front bay extending up a gabled dormer and a covered front porch marking the point of arrival. Quoins and framed windows express a sense of solidity. Sidelights and a transom window frame the main entrance, making more it visible from across the grounds.

Estimated Period of Construction	Circa 1876 Altered in 1904
Style	Georgian and Tutor Revival influences
Height (storeys)	3
Main Materials	Brick
Sub-district	A - Etobicoke Creek
Setting	Deep setback
Landscape	Open lawn with tree canopy, distinctive rise in topography, and long driveways
Notable Architectural Features	Red brick; gable roof with gabled centre dormer; projecting central bay; quoins; front porch; chimneys; decorative brackets; main entrance with sidelights and a transom window
Additional Information	

61 MAIN STREET SOUTH



STATEMENT OF CONTRIBUTION

This house is an example of a modern ranch style bungalow. Its design is notable in how its north end merges with the sloping grounds. The wide front elevation is sectioned off by large windows and spandrel panels intersperse between the brick. The house is a fine demonstration of how modern residential architecture can be sensitive to topography and recede into the landscape.

Estimated Period of Construction	1950
Style	Ranch influences
Height (storeys)	2
Main Materials	Brick and spandrel panels
Sub-district	A - Etobicoke Creek
Setting	Deep setback
Landscape	Deep lawn and tree canopy
Notable Architectural Features	Ranch style massing, and low hipped roof, basement level that merges with the site topography, buff (or yellow) brick, interspersed with large picture windows and spandrel panels.
Additional Information	

63 MAIN STREET SOUTH

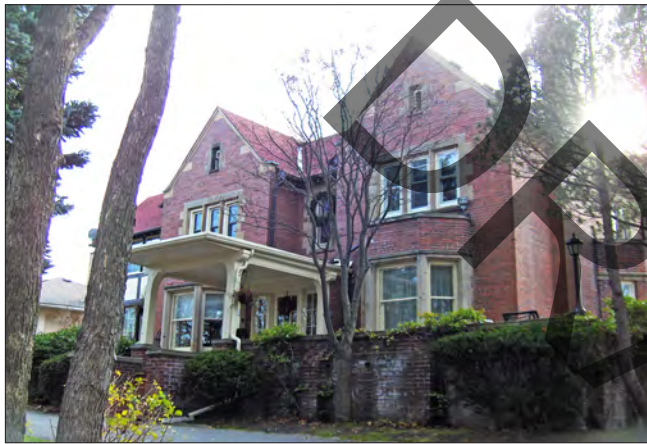
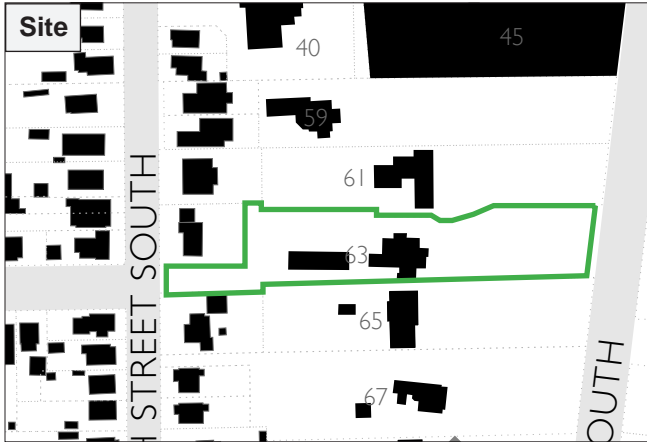

Source: PAMA



Source: PAMA

STATEMENT OF CONTRIBUTION

This grand residence is influenced by Jacobean and Tutor revival styles. It features gabled dormers on the attic level, framed windows, and one storey bay windows on the ground level, designed to echo aspects of old English estate houses.

Its siting on a rise of land set back from the street compliments its estate house style.

Estimated Period of Construction	1901-1926
Style	Jacobean and Tutor Revival influences
Height (storeys)	3
Main Materials	Brick
Sub-district	A - Etobicoke Creek
Setting	Deep setback
Landscape	Lawn with tree canopy, distinctive rise in topography, long driveways
Notable Architectural Features	Irregular gable roof with projecting gabled bays, bay windows, red brick, stone detailing, front entrance with sidelights, projecting porch, chimneys, coach house
Additional Information	

65 MAIN STREET SOUTH



STATEMENT OF CONTRIBUTION (LANDSCAPE INTEREST ONLY)

The site landscape provides tree canopy and set back from the street. Its topography relates to the historic contours of the Etobicoke Creek.

Estimated Period of Construction	Not Applicable
Style	Not Applicable
Height (storeys)	Not Applicable
Main Materials	Not Applicable
Sub-district	A - Etobicoke Creek
Setting	Deep setback
Landscape	Lawn with tree canopy
Notable Architectural Features	Not Applicable
Additional Information	

67 MAIN STREET SOUTH



Source: Historical photo courtesy of Dr Bruce Cameron

STATEMENT OF CONTRIBUTION

This is Gothic Revival style house includes key elements of the style, including a steeply pitched cross gable roof, bargeboard, and arched windows.

This site is associated with several prominent Brampton citizens: George Green, the first Crown Attorney for Peel County 1867 to 1879; John Smith , MPP 1892 - 1908 and James R. Fallis MPP 1913 and 1914.

The property helps to define, maintain and contribute to the late-19th century streetscape along Main St South.

Refer to Part IV designation bylaw for more information.

Estimated Period of Construction	1871
Style	Gothic Revival
Height (storeys)	2
Main Materials	Brick
Sub-district	A - Etobicoke Creek
Setting	Deep setback from street
Landscape	Lawn, undergrowth, tree cover, distinct rise in topography, and long driveways
Notable Architectural Features	Cross gable roof, gabled dormers, red brick, bargeboard, voussoirs, a one-storey bay window, arched windows, corbelled chimneys, verandah, pediment, and columns
Additional Information	Designated under Part IV of the Ontario Heritage Act, By-law #176-86

71 MAIN STREET SOUTH



STATEMENT OF CONTRIBUTION (LANDSCAPE INTEREST ONLY)

The site provides a deep setback from the street, tree cover, and traces of the Etobicoke Creek contours.

Estimated Period of Construction	Not Applicable
Style	Not Applicable
Height (storeys)	Not Applicable
Main Materials	Not Applicable
Sub-district	A - Etobicoke Creek
Setting	Deep setback from street
Landscape	Lawn, undergrowth, and tree cover
Notable Architectural Features	Not Applicable
Additional Information	

73 MAIN STREET SOUTH



STATEMENT OF CONTRIBUTION

This Gothic Revival residence built in the 1870s features a variety of key elements of the style including a steeply pitched cross gabled roof, gable formed, bargeboard, and lancet arch with quatrefoil detail.

The property is associated with the Heggie family, who are well-known for their medical practice. It also maintains and contributes to the conspicuous architecture along Main Street South, particularly as you approach Wellington Street.

The property is in the process of being designated by by-law under Part IV of the Heritage Act, for more information refer to the forthcoming designation by-law.

Estimated Period of Construction	1860
Style	Victorian/Craftsman
Height (storeys)	2
Main Materials	Stucco
Sub-district	A - Etobicoke Creek
Setting	Setback from street
Landscape	Lawn with some tree cover
Notable Architectural Features	Stucco cladding, gable roof, gabled dormers, bargeboard and finials on gable, front door with transom and sidelights, original corbelled chimney, bay windows, paired window on second floor, wood detailing throughout, and large porch with columns and fretwork.
Additional Information	Designated under Part IV of the Ontario Heritage Act, By-law # Forthcoming

75 MAIN STREET SOUTH

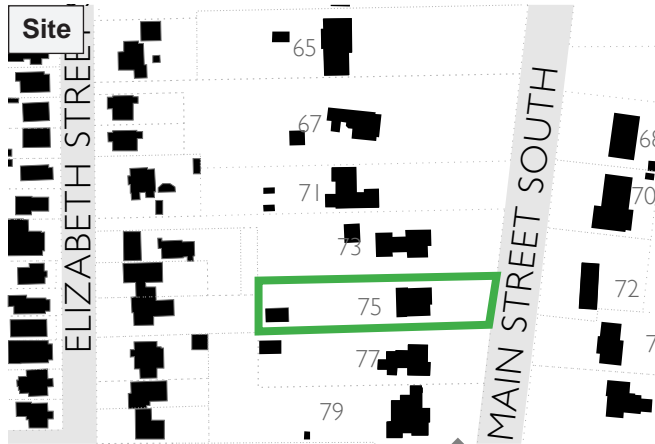

STATEMENT OF CONTRIBUTION

75 Main Street South contributes to the collection of well-designed early 20th century houses found within the District. Its massing, gabled dormer, first storey window bay and covered porch (possibly a later addition) reflects the high quality of domestic architecture found in the District.

Estimated Period of Construction	1900
Style	Victorian/Craftsman
Height (storeys)	2
Main Materials	Brick and siding
Sub-district	A - Etobicoke Creek
Setting	Setback from street
Landscape	Lawn, driveway and parking pad, tree cover
Notable Architectural Features	Cross gable roof, chimney on south elevation, single storey bay window, segmental arched window, shutters, front porch, exposed rafter tails, and entrance with sidelites and transom.
Additional Information	

77 MAIN STREET SOUTH

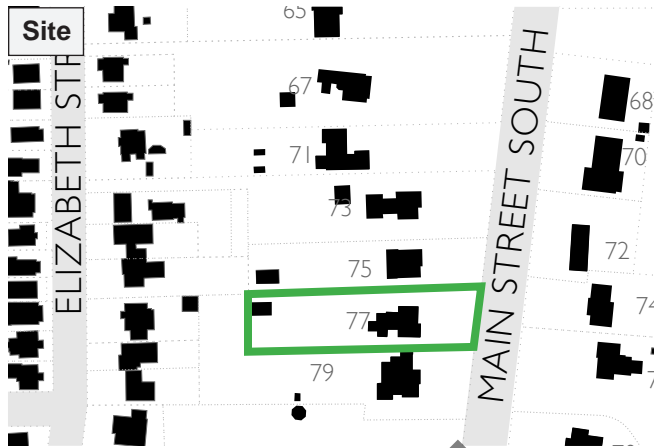

STATEMENT OF CONTRIBUTION

This late 19th century residence exhibits the Italianate style. It is distinguished by its hipped roof, decorative cornice, large bay window, and prominent windows with key stones.

Built circa 1877, the house was owned by several prominent public figures, including James A. Austin, the first County Clerk, and James Golding, a former Brampton Councilor and Mayor. It forms part of an important late 19th century historic streetscape along the southern entrance to downtown Brampton. The property both contributes to, and complements, the eclectic mix of historic homes.

Refer to Part IV designation by-law for more information.

Estimated Period of Construction	1877-83
Style	Italianate
Height (storeys)	2
Main Materials	Brick
Sub-district	A - Etobicoke Creek
Setting	Setback from Main Street South
Landscape	Lawn and terrace
Notable Architectural Features	Red brick, decorative thistle motif keystones, unusually shaped window-heads with voussoirs, wood eaves, brackets, frieze, truncated hip roof, shutters, and protruding bay window.
Additional Information	Designated under Part IV of the Ontario Heritage Act, By-law: #70-2010

79 MAIN STREET SOUTH



STATEMENT OF CONTRIBUTION

This residence was original constructed circa 1890. It was significantly altered around 2012, but maintains some of the original form and massing. It continues to contribute to the character of Main Street South with its varied architectural style.

The house was original constructed for Thomas Duggan, a prominent resident. He later moved to 83 Main Street South. The house at 79 Main Street South provides an example of contemporary architecture which uses historic materials, building forms and site planning in ways that contribute to the District.

Estimated Period of Construction	Circa 1890; modified 2012
Style	
Height (storeys)	
Main Materials	
Sub-district	A - Etobicoke Creek
Setting	
Landscape	
Notable Architectural Features	Gable roof with front gable dormers, stone and shingle cladding
Additional Information	

83 MAIN STREET SOUTH

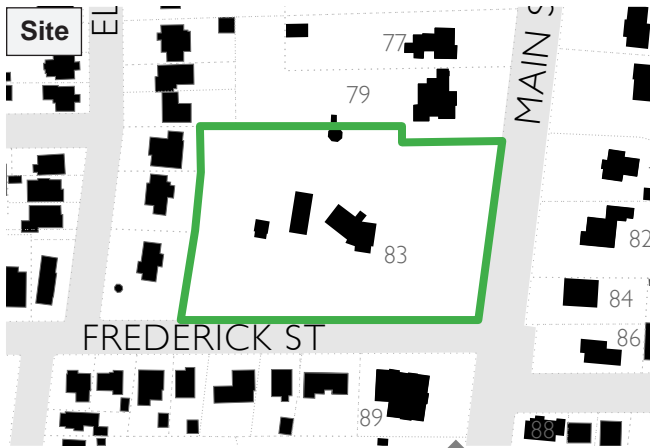

Source: PAMA

STATEMENT OF CONTRIBUTION

Once known as “Monaghan Villa”, the residence at 83 Main Street South was constructed in 1920s for Thomas Duggan. It was designed by Toronto-based architect Mackenzie Waters. The photographs show the house set amid well-established gardens.

This house is a noteworthy example of residential architecture influenced by the Arts and Crafts style. Arts and Crafts emerged in the late 19th century as artistic movement that emphasized use of traditional skills, materials and an appreciation of late medieval and pre-industrial manufacturing and design. The house exhibits informal massing, architectural composition, use of rough or texture materials and colours that reflect the aesthetic orientation of Arts and Crafts movement.

Estimated Period of Construction	1920
Style	Arts and crafts
Height (storeys)	3
Main Materials	Stucco
Sub-district	A - Etobicoke Creek
Setting	Deep setback, front elevation is offset from the street
Landscape	Screened by vegetation, mix of lawn and planting, as well as mature trees
Notable Architectural Features	Hipped roof with dormers, prominent stone chimneys, stone foundation course at the bottom of the first storey, projecting bays on second storey, multi-light windows, and coach house
Additional Information	

93 MAIN STREET SOUTH

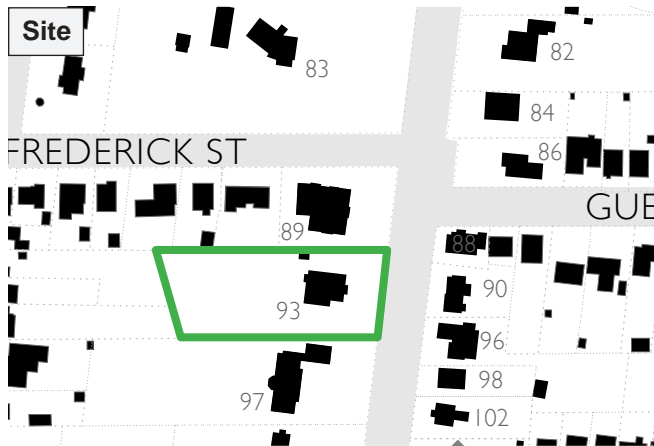

STATEMENT OF CONTRIBUTION:

The residence exhibits the Georgian style with its simple, solid and symmetrical design. It also features roughcast stucco, which is increasingly rare. The house was constructed in circa 1870 during the building boom of Brampton's historic core, and reinforced the 19th century estate character that dominates the west side of Main Street South.

Estimated Period of Construction	1874
Style	Georgian
Height (storeys)	2
Main Materials	Stucco
Sub-district	C - Town Incorporation
Setting	Setback from street
Landscape	Lawn and parking pad with plantings at front of the house and circular driveway
Notable Architectural Features	Hipped roof, symmetrical 3 bay façade centre entrance, segmental arched sash windows, window shutters, roughcast stucco, entrance hood with brackets
Additional Information	

97 MAIN STREET SOUTH

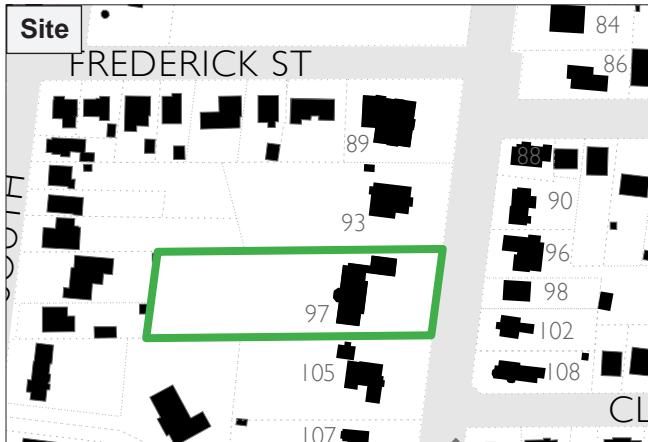

STATEMENT OF CONTRIBUTION (LANDSCAPE INTEREST ONLY)

The site provides a set of mature trees that contribute to the landscape character of Main Street South and the green procession into the downtown.

Estimated Period of Construction	Not Applicable
Style	Not Applicable
Height (storeys)	Not Applicable
Main Materials	Not Applicable
Sub-district	C - Town Incorporation
Setting	Deep setback from street
Landscape	Lawn, undergrowth, and tree cover
Notable Architectural Features	Not Applicable
Additional Information	

105 MAIN STREET SOUTH



STATEMENT OF CONTRIBUTION

This residence was originally a Gothic Revival inspired home, but underwent alterations in the 1980s. Some of the surviving original features include cross gables roof, paired decorative cornice brackets, one storey bay window, front entrance with transom and sidelights. It continues to contribute to the historic character of the neighbourhood.

Estimated Period of Construction	Appears to be have been modified circa 1980, earlier building fabric possible but date not determined.
Style	Gothic farmhouse (modified)
Height (storeys)	2
Main Materials	Brick
Sub-district	C - Town Incorporation
Setting	Setback from street
Landscape	Lawn and parking pad
Notable Architectural Features	Cross gable roof, asymmetrical front elevation, front entrance with transom and sidelights, first floor bay window, paired brackets along eaves, and front porch
Additional Information	

107 MAIN STREET SOUTH



STATEMENT OF CONTRIBUTION

107 Main Street is a typical mid-century Cape Cod style house. The building contributes to the collection of modern residential building found within the District, representing house construction during the mid-20th century, and the evolution of architectural styles in the district.

Estimated Period of Construction	1950-1960
Style	Cape Cod
Height (storeys)	1 1/2
Main Materials	Stucco/wood cladding
Sub-district	C - Town Incorporation
Setting	Setback from street
Landscape	Lawn and mature trees
Notable Architectural Features	Steep gable roof, symmetrical front elevation, door surround, twin dormers, shutters on the ground floor
Additional Information	

115 MAIN STREET SOUTH



STATEMENT OF CONTRIBUTION (LANDSCAPE INTEREST ONLY)

This site provides a large landscaped open area along the street. The front yard supports the pattern of front yard setbacks to the north and south.

Estimated Period of Construction	Not Applicable
Style	Not Applicable
Height (storeys)	Not Applicable
Main Materials	Not Applicable
Sub-district	C - Town Incorporation
Setting	Setback from street
Landscape	Open lawn with some tree cover
Notable Architectural Features	Not Applicable
Additional Information	

117 MAIN STREET SOUTH

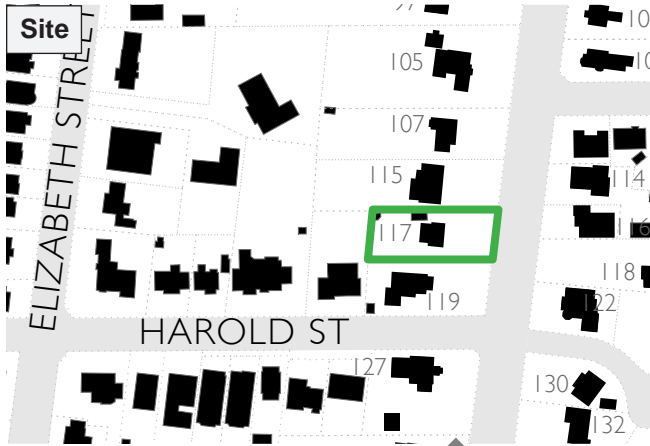

STATEMENT OF CONTRIBUTION

Similar to 107 Main Street, this house is a typical mid-century Cape Cod style house. It contributes to the collection of modern residential buildings found within the District, representing house construction during the mid-20th century, and the evolution of architectural styles in the district.

Estimated Period of Construction	1941-1980
Style	Cape Cod (modified)
Height (storeys)	1 1/2
Main Materials	Siding
Sub-district	C - Town Incorporation
Setting	Setback from street
Landscape	Lawn with circular driveway and tree cover with gardens near house
Notable Architectural Features	Gambrel roof with three dormers, symmetrical front elevation, centre entrance with sidelights and transom, and shutters on ground floor windows
Additional Information	

119 MAIN STREET SOUTH



STATEMENT OF CONTRIBUTION

This vernacular home built circa 1900 incorporates elements from the Queen Ann and Edwardian styles. It has been modified through the enclosure of the front porch and the incorporation of a rear addition, however the general massing and front façade are illustrative of the historic building type.

Estimated Period of Construction	1900
Style	Edwardian (modified)
Height (storeys)	2
Main Materials	Siding, brick, and shingle
Sub-district	C - Town Incorporation
Setting	Setback from street
Landscape	Lawn with trees at sidewalk
Notable Architectural Features	Gable roof, shingle pattern at the top of gable end, shutters at second storey windows.
Additional Information	

127 MAIN STREET SOUTH

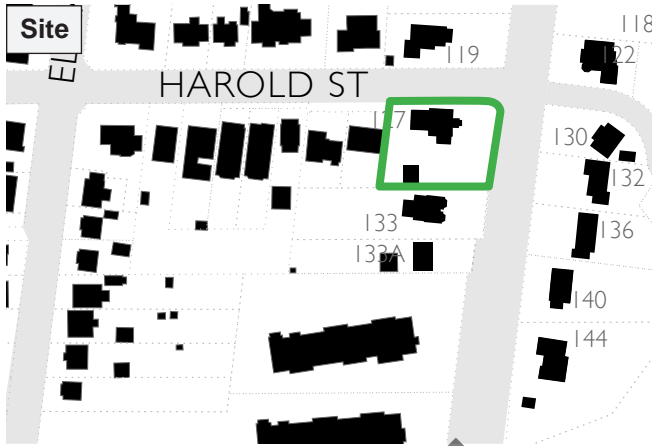

STATEMENT OF CONTRIBUTION

This house is a well maintained example of the Four Square style which was used widely in North America during the early 20th century. The building's symmetrical front elevation, simple porch with rusticated stone piers, columns and gable roof, along with stone (or concrete) window lintels are elements associated with the Four Square style. The house contributes to the range of residential architectural styles found within the District.

Estimated Period of Construction	1920
Style	Four square
Height (storeys)	2 1/2
Main Materials	Brick and stone
Sub-district	C - Town Incorporation
Setting	Setback from street
Landscape	Lawn, tree cover, and ground cover
Notable Architectural Features	Hipped roof with dormers, symmetrical front elevation, stone sills and lintels, centre front entrance with sidelights, porch with plain entablature and columns sitting on stone base, as well as, column-like railing ends on porch
Additional Information	

133 MAIN STREET SOUTH

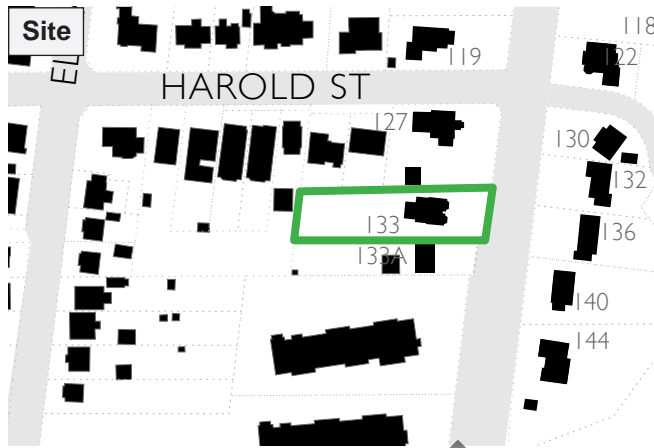

Source: PAMA

STATEMENT OF CONTRIBUTION

The Kirkwood House is a Gothic Revival style residence distinguished by the prominent gabled roof line, symmetrical massing, bay windows, dichromatic brickwork, arched windows, and attractive front entrance. It is associated with Kirkwood family, who are among a group of significant and long-standing families in Brampton. The property was built for David Kirkwood.

Kirkwood House is also supported by its contextual value, as it contributes to the 19th century historic strip of Main St South. The large open lot filled with older deciduous trees contributes to the mature vegetation that further characterizes the streetscape.

Refer to Part IV designation by-law for additional information.

Estimated Period of Construction	1870-1880
Style	Gothic Revival
Height (storeys)	2
Main Materials	Brick
Sub-district	C - Town Incorporation
Setting	Setback from street
Landscape	Large open lot filled with mature deciduous trees
Notable Architectural Features	Steeply-pitched triple gables, symmetrical massing, two bay windows, arched windows, dichromatic brickwork, quoins, vousoirs, projecting brick details in a saw tooth or diamond pattern, stone sills, and front entrance with transom and sidelights
Additional Information	Designated under Part IV of the Ontario Heritage Act, By-law #33-2006

EAST SIDE

DRAFT

52 MAIN STREET SOUTH

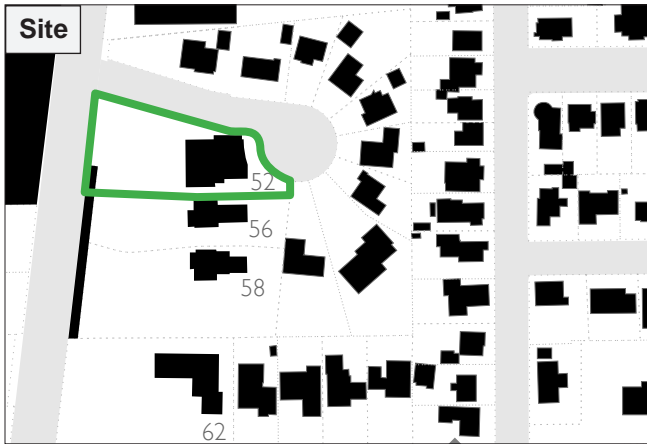

Source: PAMA

STATEMENT OF CONTRIBUTION

52 Main Street South is among the older houses in the District, dating from the mid-19th century. It was owned by a well known business man, Christopher Stork, and is associated with the Bull family.

Despite later alterations, it exhibits features of the Italianate style such as its hipped roof, paired decorative brackets, central bay dormer, and massing. The front porch appears to be a later addition.

Estimated Period of Construction	1850-1870
Style	Italianate
Height (storeys)	2 1/2
Main Materials	Stucco/cladding
Sub-district	A - Etobicoke Creek
Setting	Set back from Main Street South behind parking lot
Landscape	Hedges and gardens at the foot of the house
Notable Architectural Features	Hipped roof, prominent centre dormer, brackets, centre entrance with large transom
Additional Information	

56 MAIN STREET SOUTH

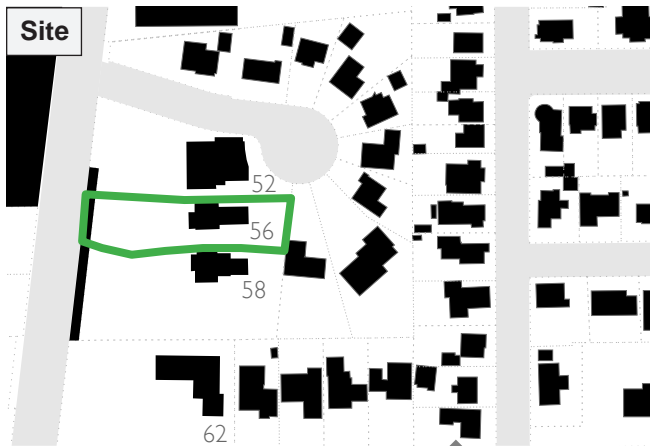

Source: PAMA

STATEMENT OF CONTRIBUTION

Among a series of 19th century grand residences approaching the northern limits of the District, 56 Main Street is an Italianate style home set in a picturesque landscape. The house features decorative cornice with brackets, prominent central dormer, bay window, and window moulds with keystones. The property reflects the original route of the Etobicoke Creek and contains remnants of the former retaining walls of the creek. The property is also associated with notable early Brampton families including the Storks and the Hewetsons.

Estimated Period of Construction	Circa 1880
Style	Italianate and Georgian influence
Height (storeys)	2 1/2
Main Materials	Brick
Sub-district	A - Etobicoke Creek
Setting	Setback from street
Landscape	Lawn with tree canopy, distinct rise in topography, remnants of Etobicoke Creek retaining wall
Notable Architectural Features	Hipped roof, prominent centre dormer, decorative brick hoods, decorative cornice with brackets, bay windows, sash windows, corbeled chimneys, entrance with transom and sidelights, and partially enclosed front porch with iron cresting
Additional Information	

58 MAIN STREET SOUTH

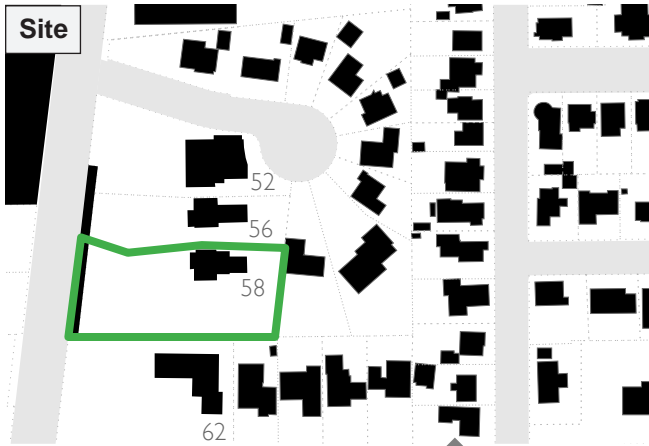

Source: PAMA, annotated by ERA.

STATEMENT OF CONTRIBUTION

58 Main Street contains a large residence set in a picturesque landscape. The two storey house exhibits Italianate architectural influence and features a decorative cornice with brackets, buff brick quoining, bay window and a large front porch. The spacious grounds compliment the design of the house which sits atop a rise in the topography that resulted from the Etobicoke Creek that once ran at the foot of the lot. The property is associated with the Stork and Robinson families, members of who were prominent business persons in the 19th and 20th century.

Estimated Period of Construction	1881
Style	Italianate
Height (storeys)	2
Main Materials	Brick
Sub-district	A - Etobicoke Creek
Setting	Deep setback
Landscape	Lawn with tree canopy distinct rise in topography, remnants of Etobicoke Creek retaining wall
Notable Architectural Features	Red brick,hipped roof with projecting gabled bay, brick quoins, decorative buff brick feature at gable end, decorative cornice with brackets, bay windows, porch, window hoods, shutters.
Additional Information	

62 MAIN STREET SOUTH

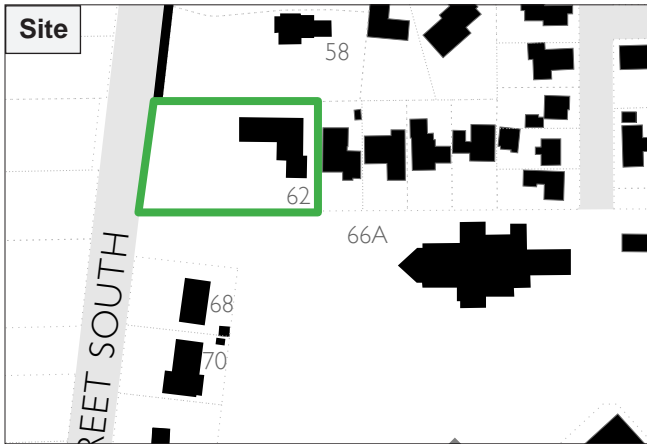

STATEMENT OF CONTRIBUTION (LANDSCAPE INTEREST ONLY)

62 Main Street's landscape is notable for its deep setback and its visibility at the north side of grounds of St. Mary's Church.

Estimated Period of Construction	Not Applicable
Style	Not Applicable
Height (storeys)	Not Applicable
Main Materials	Not Applicable
Sub-district	A - Etobicoke Creek
Setting	
Landscape	Open lawn with some tree cover
Notable Architectural Features	
Additional Information	

66A MAIN STREET SOUTH (ST. MARY'S)

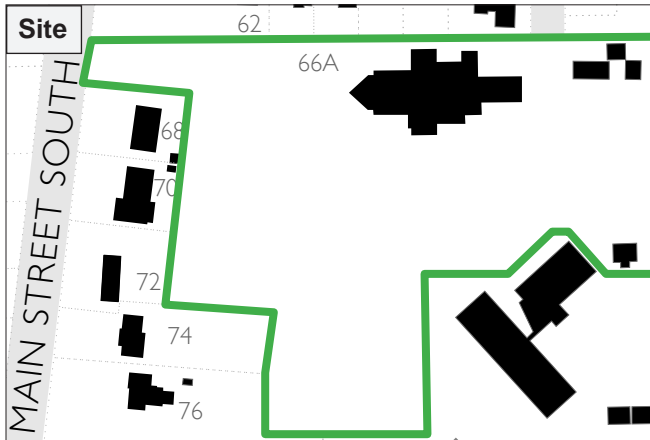

Source: PAMA

STATEMENT OF CONTRIBUTION

66A Main Street represents modernist architecture in the District and a period of construction spanning from 1940 to 1980. As a place of worship, it contributes to the variety of building forms within an area that is largely comprised of houses.

Estimated Period of Construction	1960
Style	Modernist
Height (storeys)	2+
Main Materials	Brick and metal window wall panels
Sub-district	A - Etobicoke Creek
Setting	Setback from the street beyond a parking lot, surrounded by an asphalt driveway
Landscape	Lawns with walking paths, and mature trees
Notable Architectural Features	Triangular roof form and massing, geometric pattern comprised of contrasting brick, glass and panels
Additional Information	

68 MAIN STREET SOUTH

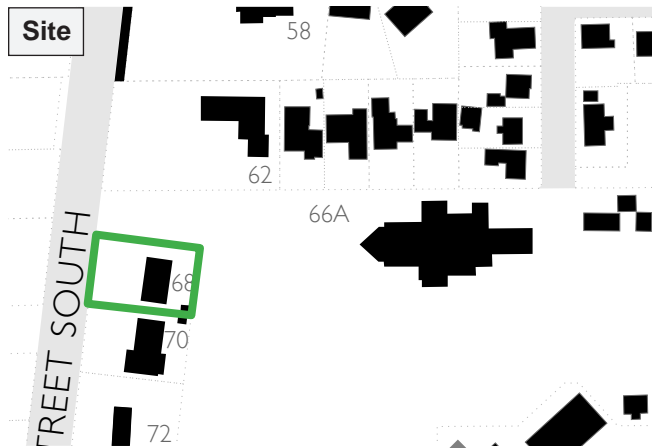

STATEMENT OF CONTRIBUTION

68 Main Street is a representative example of the ranch-style bungalow popular between 1940-1980. Typical of the style, the house is defined by its low pitched roof, and its long, narrow, horizontal layout, and is low to the ground. The building also includes elements of Craftsman styles as popularized in suburban housing during the mid-20th century.

Estimated Period of Construction	1956-1970
Style	Ranch bungalow
Height (storeys)	1
Main Materials	Stone cladding front elevation
Sub-district	A - Etobicoke Creek
Setting	Setback from street
Landscape	Screened by vegetation, manicured shrubs, and deep lawn
Notable Architectural Features	Low sloping hipped roof, horizontal composition, oversized eaves, large picture windows
Additional Information	

70 MAIN STREET SOUTH

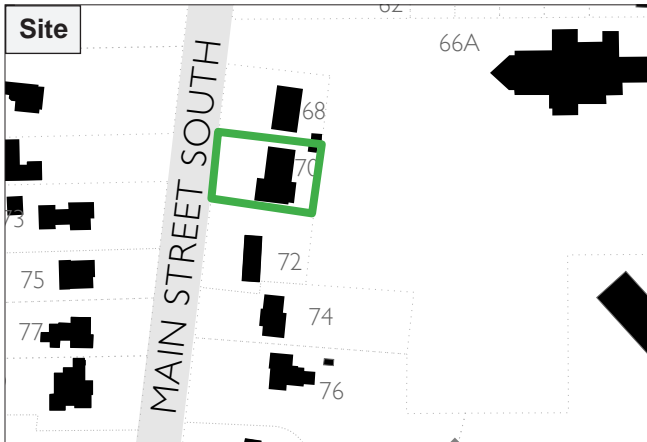

STATEMENT OF CONTRIBUTION (LANDSCAPE INTEREST ONLY)

70 Main Street's landscape is of interest for its tree cover.

Estimated Period of Construction	Not Applicable
Style	Not Applicable
Height (storeys)	Not Applicable
Main Materials	Not Applicable
Sub-district	A - Etobicoke Creek
Setting	Limited setback with tree cover
Landscape	Open lawn with some tree cover
Notable Architectural Features	Not Applicable
Additional Information	

72 MAIN STREET SOUTH



STATEMENT OF CONTRIBUTION

72 Main Street represents the early popularization of modernist design. It exhibits a design language focused on geometric massing and avoidance of historic references. Its form and timber cladding is unique in the District. It speaks to a broad range of architectural expression found within the District.

Estimated Period of Construction	1940-1970
Style	Eclectic split level bungalow with Modernist influences
Height (storeys)	1 storey split level
Main Materials	Timber cladding
Sub-district	A - Etobicoke Creek
Setting	Setback form the street
Landscape	Lawn and treed
Notable Architectural Features	Low sloping roof, Stained timber cladding, using vertical and horizontal planking pattern, asymmetrical sloping roof, window form matches slope of roof, large eave overhang over north and south elevations
Additional Information	

74 MAIN STREET SOUTH

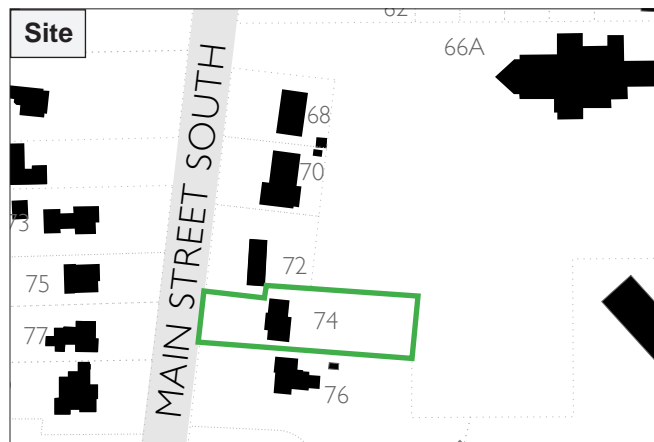

STATEMENT OF CONTRIBUTION (LANDSCAPE INTEREST ONLY)

74 Main Street's landscape is of interest for its deep setback and mature tree cover.

Estimated Period of Construction	Not Applicable
Style	Not Applicable
Height (storeys)	Not Applicable
Main Materials	Not Applicable
Sub-district	A - Etobicoke Creek
Setting	Limited setback with tree cover
Landscape	Open lawn with some tree cover
Notable Architectural Features	Not Applicable
Additional Information	

76 MAIN STREET SOUTH

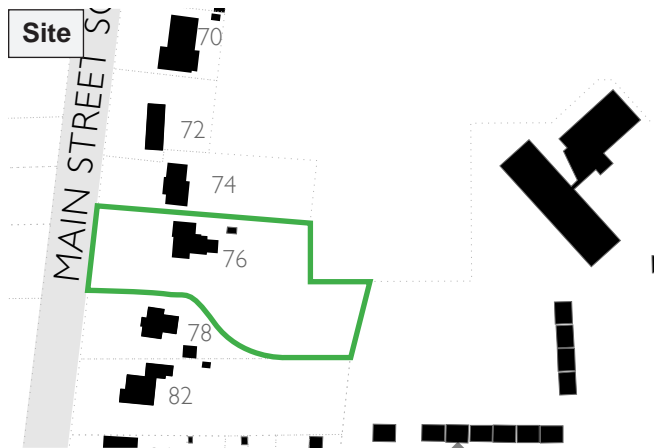

STATEMENT OF CONTRIBUTION

76 Main Street provides an example of the historic massing and form of early houses in the District. Its front elevation features a projecting gabled bay, one-story bay window, covered porch, combined to form a simple yet well balanced front elevation.

Built during the later half of the 19th century, the residence is associated with several distinguished families in Brampton including the Clarks, Austins, Jacksons and former Brampton mayor, F.W. Wegenast.

Estimated Period of Construction	Circa 1875
Style	Victorian with Italianate influences
Height (storeys)	2
Main Materials	Aluminum cladding over stucco
Sub-district	A - Etobicoke Creek
Setting	Deep setback from the street
Landscape	Open lawn
Notable Architectural Features	Hipped roof with projecting gable bay, bay window, large porch, and second storey paired windows
Additional Information	

78 MAIN STREET SOUTH

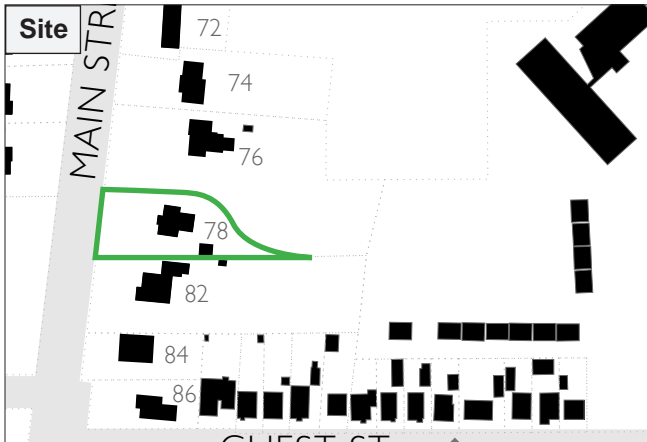

STATEMENT OF CONTRIBUTION

This house is an example of residential architecture from the early 20th century. It demonstrates a shift away from detailed ornamentation and complex massing characteristic of late-19th century styles, and anticipates design language characteristic of the Edwardian period and later modernist architecture.

Estimated Period of Construction	1920-1940
Style	
Height (storeys)	2
Main Materials	Stucco
Sub-district	A - Etobicoke Creek
Setting	Setback from street
Landscape	Manicured garden and front lawn with parking
Notable Architectural Features	Hipped roof, centre entrance, bay window, centre gabled bay, porch, entrance with sidelights, and eight-over-one windows
Additional Information	

82 MAIN STREET SOUTH

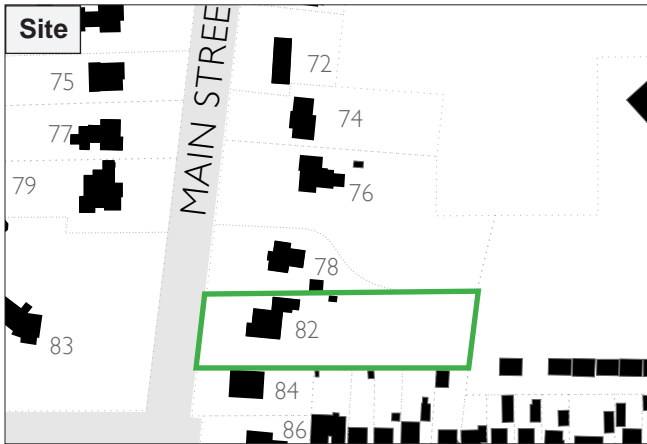

STATEMENT OF CONTRIBUTION

Built between 1920-1940, it exhibits the English Cottage Revival style as seen in the asymmetrical façade, steeply pitched cross gable roof, projecting entrance with heavy wooden arched door arched and surrounded by stone. The house also originally features multi-paned wood windows and cedar shingle cladding.

Estimated Period of Construction	1920-1940
Style	English Cottage Revival
Height (storeys)	2
Main Materials	Stucco
Sub-district	A - Etobicoke Creek
Setting	Limited setback with tree cover
Landscape	Open lawn with some tree cover
Notable Architectural Features	Asymmetrical façade, steeply pitched cross gable roof, gable dormer, rounded entrance surrounded by stone, and wooden front door
Additional Information	

84 MAIN STREET SOUTH



STATEMENT OF CONTRIBUTION

Dating from the mid 19th century, 84 Main Street South is among the older houses in the District. 84 Main Street South originally exhibited Gothic Revival design elements, and alterations over time introduced a Georgian influence. The residence retains several original or early details including front entrance with transom and side-lights, twelve-over-twelve wood sash windows, wood shutters.

A row of three dormers at the front elevation that were added creates a distinctive massing. The front entrance and canopy add to its historic character.

Estimated Period of Construction	Circa 1860
Style	Georgian influence
Height (storeys)	1 1/2
Main Materials	Brick
Sub-district	A - Etobicoke Creek
Setting	Setback from street
Landscape	Open lawn with planting beds near house
Notable Architectural Features	Brick gable roof, symmetrical front elevation, three dormers, pair of chimneys at north and south ends of the roof, twelve-over-twelve sash windows, flat window arches, centre entrance with side lights and transom, canopy over entrance, and shutters
Additional Information	

86 MAIN STREET SOUTH



STATEMENT OF CONTRIBUTION

86 Main Street South contains a two-storey Victorian style brick residence with a cross-gable roof and minimal ornamentation. It contributes to the mix of architectural styles along Main St South. This house is representative of residential architecture from the early 20th century. Its simple, unadorned elevations represent a shift away from the ornamentation and complex massing of earlier Victorian-period architecture.

Estimated Period of Construction	Circa 1900
Style	Victorian
Height (storeys)	2 1/2
Main Materials	Brick
Sub-district	A - Etobicoke Creek
Setting	Setback from street
Landscape	Lawn with some tree canopy
Notable Architectural Features	Red brick, cross gable roof, projecting gable end, and symmetrical front elevation with little ornamentation
Additional Information	

96 MAIN STREET SOUTH



STATEMENT OF CONTRIBUTION (CONTRIBUTING BUILDING ONLY)

The house includes older brick core which reflects an earlier phase of construction within the District. Latter alterations, including the enclosed front porch and side addition are have limited architectural historic value.

Estimated Period of Construction	1900-1940
Style	Gothic Revival, modified
Height (storeys)	2
Main Materials	Brick (on historic main building)
Sub-district	B - Guest Plan
Setting	Limited setback
Landscape	Not applicable
Notable Architectural Features	Brick upper storey, gable end, second storey windows with shutters (shutters may not be original).
Additional Information	

98 MAIN STREET SOUTH



STATEMENT OF CONTRIBUTION
(LANDSCAPE INTEREST ONLY)

The site landscape is of interest for its tree at the front of the site near the sidewalk.

Estimated Period of Construction	Not applicable
Style	Not applicable
Height (storeys)	Not applicable
Main Materials	Not applicable
Sub-district	B - Guest Plan
Setting	Limited setback with a tree
Landscape	Open lawn with a tree
Notable Architectural Features	Not applicable
Additional Information	

102 MAIN STREET SOUTH



STATEMENT OF CONTRIBUTION

102 Main Street South is a good example of an Ontario Cottage, a regional variant of the Gothic Cottage. This dwelling is believed to be one of the oldest houses in the Main Street South neighbourhood. It is 1½ storeys high with a hipped roof and centre cross gable sheltering a small lancet louvered vent. Its three bay façade contains a centred door with transom. The house has been re-clad in vinyl siding, and a portico has been added to the front entrance.

Estimated Period of Construction	1870-1888
Style	Gothic revival
Height (storeys)	1 1/2
Main Materials	Vinyl cladding
Sub-district	B - Guest Plan
Setting	Close to street/minimal setback
Landscape	Asphalt parking pad
Notable Architectural Features	Hipped roof, centre cross gable, lancet louvered vent, symmetrical façade, centred door with transom
Additional Information	

108 MAIN STREET SOUTH



STATEMENT OF CONTRIBUTION

This house exemplifies the use of decorative brick and woodwork of late 19th century residential architecture. Its front entrance, with sidelights and transom, further exemplify the sophistication and refinement of design during this period.

Estimated Period of Construction	1887
Style	Victorian
Height (storeys)	2
Main Materials	Brick
Sub-district	B - Guest Plan
Setting	Close to street/minimal setback
Landscape	Asphalt parking pad, and mature trees
Notable Architectural Features	Irregular roofline, red brick, buff brick window hoods, bay window with decorative molding above, decorative enclosed front entrance with side lights and transom
Additional Information	

114 MAIN STREET SOUTH

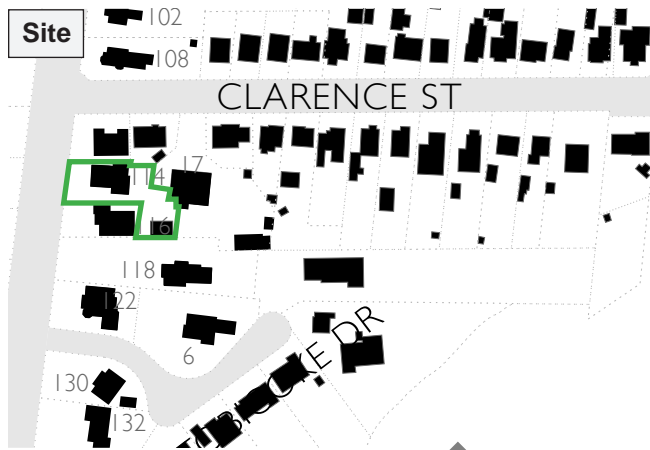

STATEMENT OF CONTRIBUTION

This modest one story house is an example of post-war domestic architecture within the District.

The house was built as a centrepiece model home of the Credit Valley Stone Company, and is believed to be the first bungalow of its kind built in Brampton. Some of the stone used came from the Pottsville sandstone quarry that also supplied stone for Frank Lloyd Wright's iconic Pennsylvania landmark, "Fallingwater."

Estimated Period of Construction	1950
Style	Modernist
Height (storeys)	1
Main Materials	Angel stone cladding
Sub-district	C - Town Incorporation
Setting	Near the street, some ground and tree cover
Landscape	Treed front lawn
Notable Architectural Features	Low hipped roof, picture window, stone, covered front veranda, and terraced planter.
Additional Information	

118 MAIN STREET SOUTH

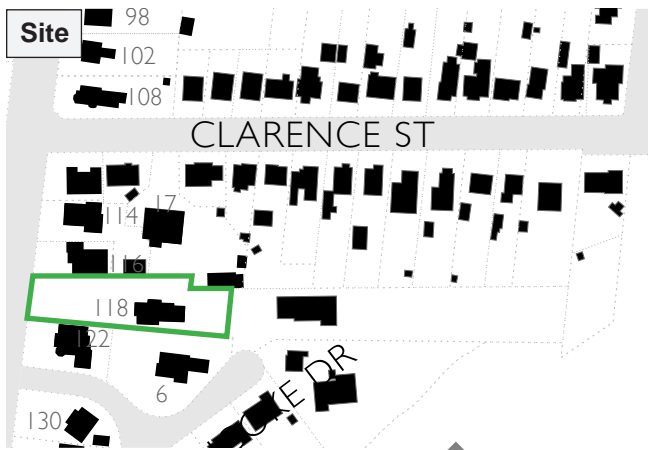

STATEMENT OF CONTRIBUTION

This grand two and a half storey house maintains architectural features and massing associated with late 19th century domestic architecture. It exhibits the variation and asymmetry of the Queen Anne style. Its setback on a treed lot provides a site that compliments its historic architectural character.

The property is associated with the Bull family, who played a large part in the establishment of Brampton and was prominent throughout its history.

Estimated Period of Construction	1890s
Style	Queen Anne
Height (storeys)	2
Main Materials	Brick
Sub-district	C - Town Incorporation
Setting	Setback from street
Landscape	Mix of lawn, driveway, and tree cover
Notable Architectural Features	Red brick, asymmetrical façades, steeply pitched irregular roof, large gable brackets, large wrap around porch, lancet window in gabled bay, second storey balcony, sash windows, entrance with transom and sidelights, decorative brickwork, wood soffit and fascia
Additional Information	

6 ETOBICOKE DRIVE

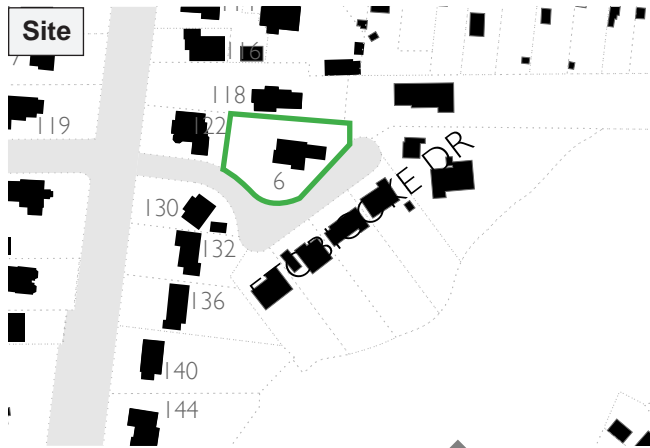

STATEMENT OF CONTRIBUTION

With an original address of 122 Main Street South 6 Etobicoke Creek, like its sister home, 118 Main Street South, is a grand residence that features asymmetrical façades, steeply-pitched and irregular roofline, and a front-facing gable bay. The texture in the brickwork also contributes to the character of the house.

The property is associated with the esteemed Bull family, and is known as the Harper Bull residence. Harper Bull served three terms as Mayor as well as being justice of the peace.

Estimated Period of Construction	1880-1890
Style	Queen Anne
Height (storeys)	2 1/2
Main Materials	Brick
Sub-district	C - Town Incorporation
Setting	Setback from street
Landscape	Circular drive, lawn and treed
Notable Architectural Features	Red brick, asymmetrical façade, steeply pitched irregular roof, dormers, large gable brackets, decorative brick bands, exposed rafter tails, large two porch with balcony above, corbelled chimneys
Additional Information	

132 MAIN STREET SOUTH

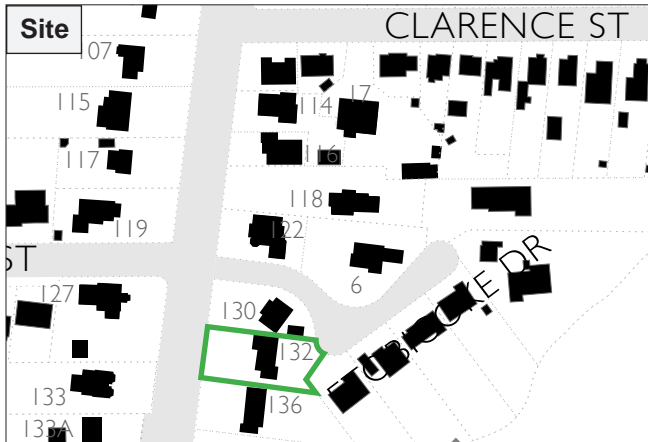

STATEMENT OF CONTRIBUTION (LANDSCAPE INTEREST ONLY)

The landscape at 132 Main Street is of interest due to its tree cover.

Estimated Period of Construction	Not Applicable
Style	Not Applicable
Height (storeys)	Not Applicable
Main Materials	Not Applicable
Sub-district	C - Town Incorporation
Setting	Limited setback, lawn with tree cover
Landscape	Lawn and Treed
Notable Architectural Features	Not Applicable
Additional Information	

136 MAIN STREET SOUTH

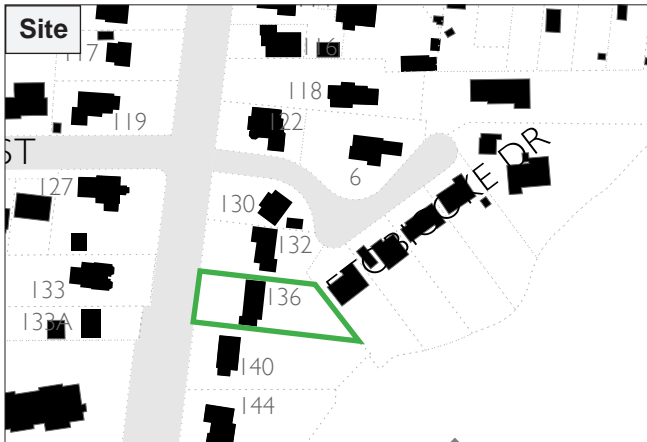

STATEMENT OF CONTRIBUTION (LANDSCAPE INTEREST ONLY)

134 Main Street in of interest due to the mature tree next to the sidewalk.

Estimated Period of Construction	Not Applicable
Style	Not Applicable
Height (storeys)	Not Applicable
Main Materials	Not Applicable
Sub-district	C - Town Incorporation
Setting	Limited setback, lawn mature tree.
Landscape	Open lawn with some tree cover
Notable Architectural Features	Not Applicable
Additional Information	

140 MAIN STREET SOUTH

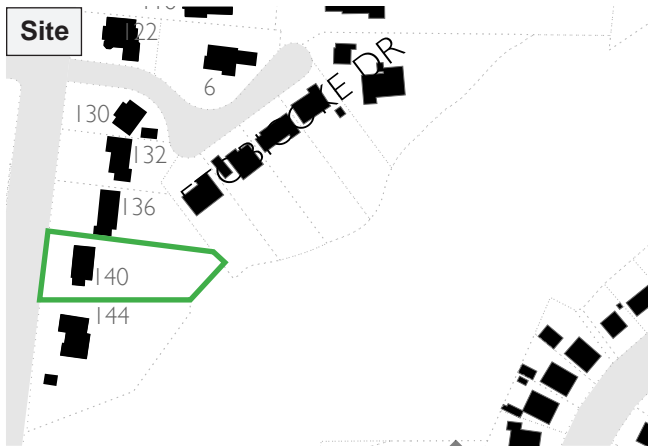

STATEMENT OF CONTRIBUTION

This one and a half storey house is an example of the smaller-scale buildings within the District. The modest design speaks to a taste for simplicity evident early 20th century house design. The large dormer appears to be a later addition.

Estimated Period of Construction	1900-1940
Style	Cape Cod
Height (storeys)	1 1/2
Main Materials	Stucco cladding
Sub-district	C - Town Incorporation
Setting	Setback from street
Landscape	Circular driveway, lawn and tree cover with plantings around foundation edge
Notable Architectural Features	Gable roof with dormer, arched main entrance, one and a half storey Cape Cod style form
Additional Information	

144 MAIN STREET SOUTH

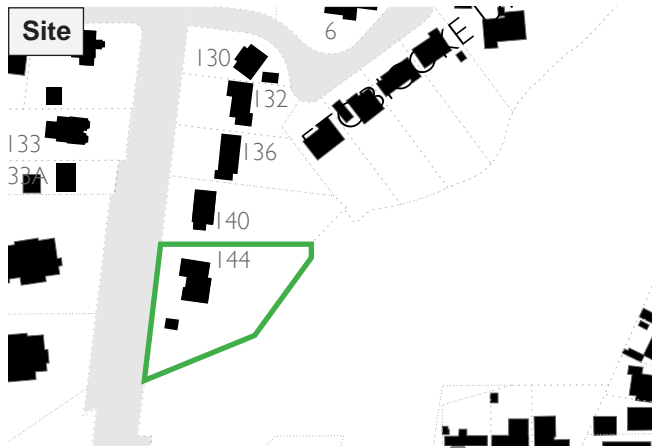

STATEMENT OF CONTRIBUTION

The house marks the south end of the District on the east side of Main Street South. It contributes to the District as an example of 19th century farmhouse architecture. The house has been modified. An addition was built onto the south façade, as well as quoining and window hoods were added.

Estimated Period of Construction	1900-1940
Style	Gothic Revival (with decorative elements influenced by the French Second Empire style)
Height (storeys)	2
Main Materials	Brick
Sub-district	C - Town Incorporation
Setting	Setback from street
Landscape	Parking pad with plantings near front porch
Notable Architectural Features	Gable end form typical of 19th century farmhouses, (quoins and window hoods appear to have been modified or are later alterations)
Additional Information	



APPENDIX 2:
ARCHITECTURAL STYLE GUIDE
MAIN STREET SOUTH HERITAGE
CONSERVATION DISTRICT

Appendix 2 of the Main Street South Heritage
Conservation District Plan

JANUARY 2016

ERA

CONTENTS

GOTHIC REVIVAL	3
GOTHIC FARMHOUSE	4
GEORGIAN INFLUENCE	5
ITALIANATE	6
VICTORIAN	7
QUEEN ANNE	8
REGENCY	9
ARTS AND CRAFTS	10
EDWARDIAN	11
CRAFTSMAN BUNGALOW	12
FOUR SQUARE	13
CAPE COD	14
RANCH	15
MODERNIST	16
CONTEMPORARY	17

DRAFT

GOTHIC REVIVAL

PERIOD OF POPULARITY: EARLY AND MID-1800S

Gothic Revival style was a translation of English Gothic and medieval architecture details and building practices to the Ontario context. The overall effect is usually ornate and eclectic, typically emphasizing the verticality of the building. The style reflected an interest in the picturesque and romantic movement of the early 19th century. The style is associated with an interest in rural landscapes promoted in the 1840s and '50s by writer Andrew Jackson Downing. Common features include decorative brick and vergeboarding, finials, scalloping, and lancet (or gothic arched) windows. The style is characterized by steeply sloped roofs, which creates an emphasis on verticality.

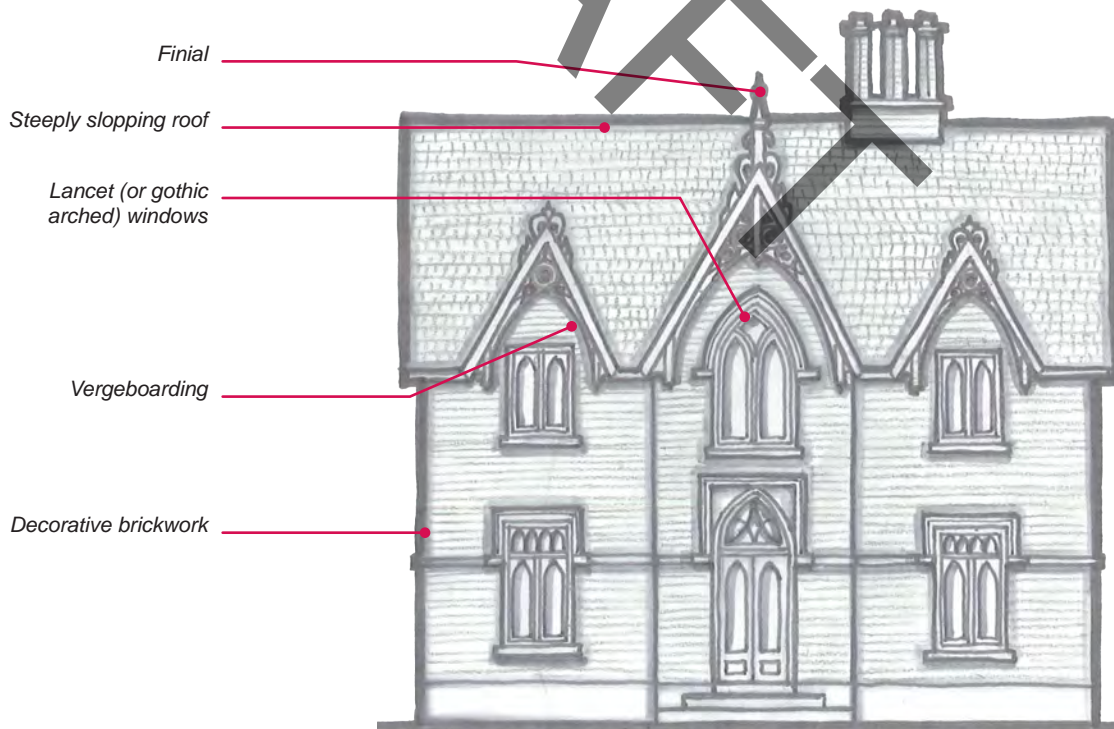

GOTHIC FARMHOUSE (ALSO KNOWN AS THE ONTARIO COTTAGE)

PERIOD OF POPULARITY: MID 1800S

Usually symmetrical with tall peaks, this architectural style was pervasive during the 1800s. In Ontario, they are characterized by a one-and-a-half storey height, which allowed for two levels at a cheaper tax rate, with a steeply pitched roof and frequently front gables with a decorative bargeboard and finials. Common features also included sash windows and shutters, and a simple entrance with a transom window.

The Gothic farmhouse was often a vernacular or simplified variant of Gothic Revival style that emerged in the early 1800s.

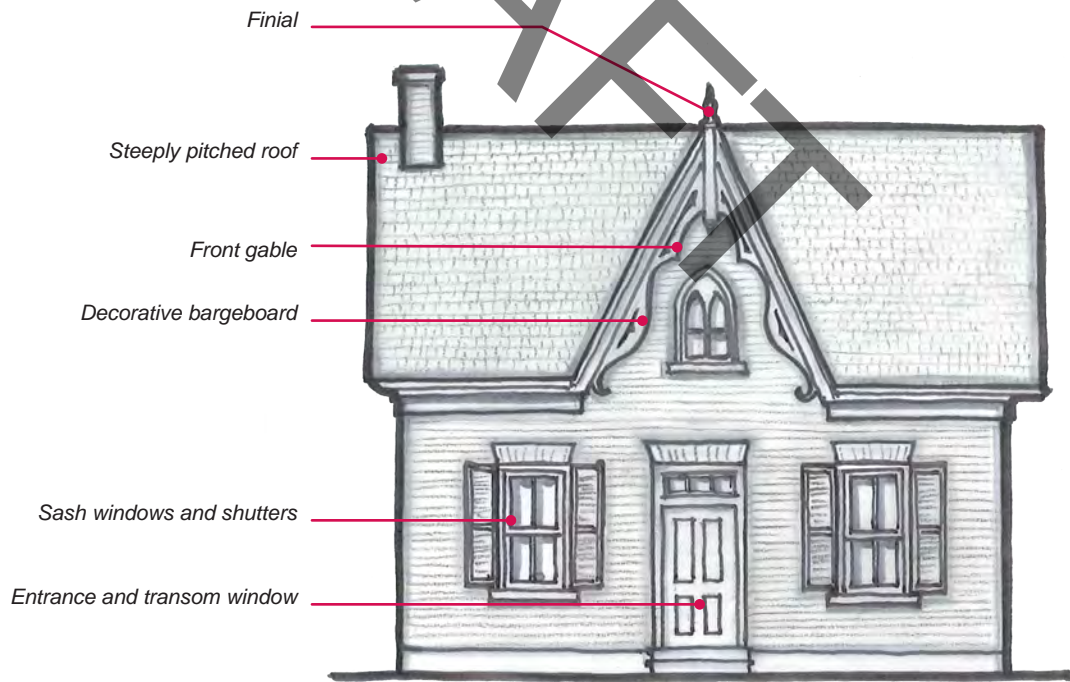

GEORGIAN INFLUENCE

PERIOD OF POPULARITY: EARLY 1800S

This style represented architectural fashion during the reign of King George I of England (1750-1820). Georgian is identified by the balanced or symmetrical facades, centre framed entrance (often with a transom and sidelights), regularly spaced window bays, muted ornament, and minimal detailing. The use of a hipped roof with flanking chimney stacks is also a common element. Conceptually, the style reflected the virtues of symmetry, solidity, and simple dignity.

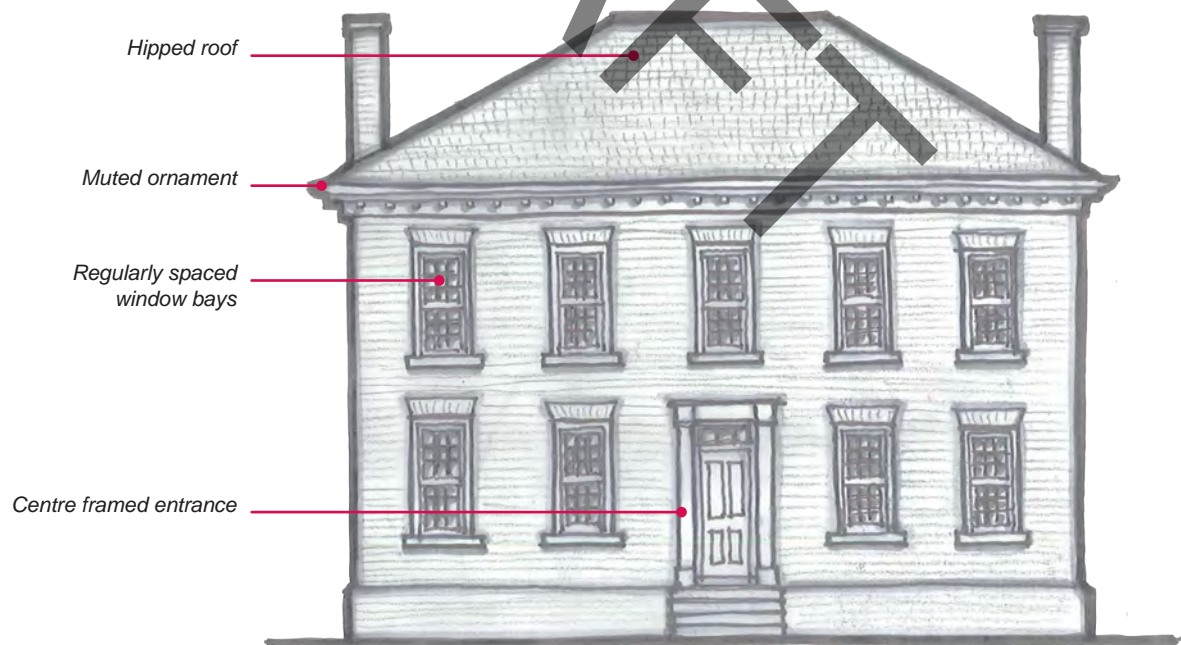

ITALIANATE

PERIOD OF POPULARITY: MID TO LATE 1800S

Ornate with a silhouette reminiscent of Italian country villas, this style was popular between 1850-1900. Its trademarks include irregular roof lines (including monitors or belvederes), expressive brick detail and textured materials, cornices, capitals, triglyphs, and metopes and brackets. Windows are often round headed and framed by decorative brick hoods, shutters and expressive sills. The entrance is often marked by an elaborately designed porch or verandah. A variation of the style, Italian Villa, commonly included tower features, asymmetrical or an irregular massing.

The style evoked a sense of leisurely sophistication and old world gentility.

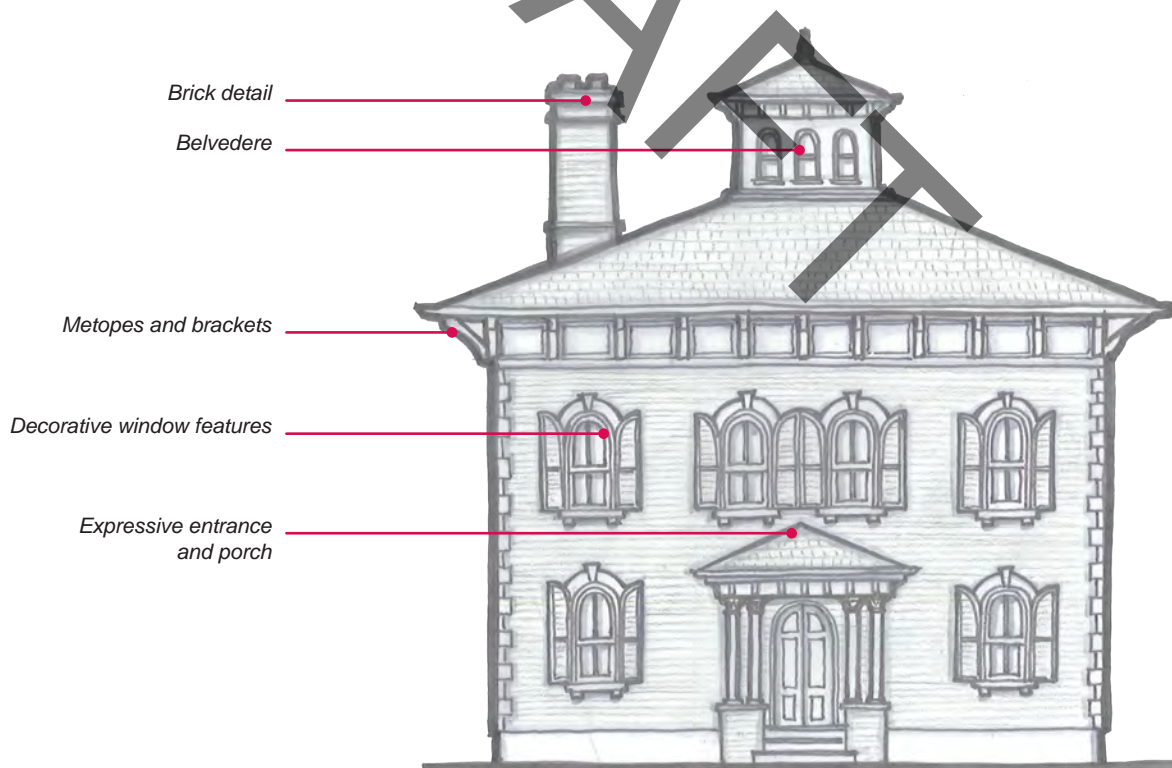

VICTORIAN

PERIOD OF POPULARITY: MID-1800S

This broad category is associated with the reign of Queen Victoria. The category encompasses a broad range of styles that emphasize orientation, irregular massing, a range of materials, and references to historic and exotic styles. Architectural features include bays, sash windows, round headed window openings, stained glass, ornamental string courses, brick quoins and chimney stacks. Also common are elegant, decorative gable ends and entrances. Decorative elements combine to provide a unity of design.

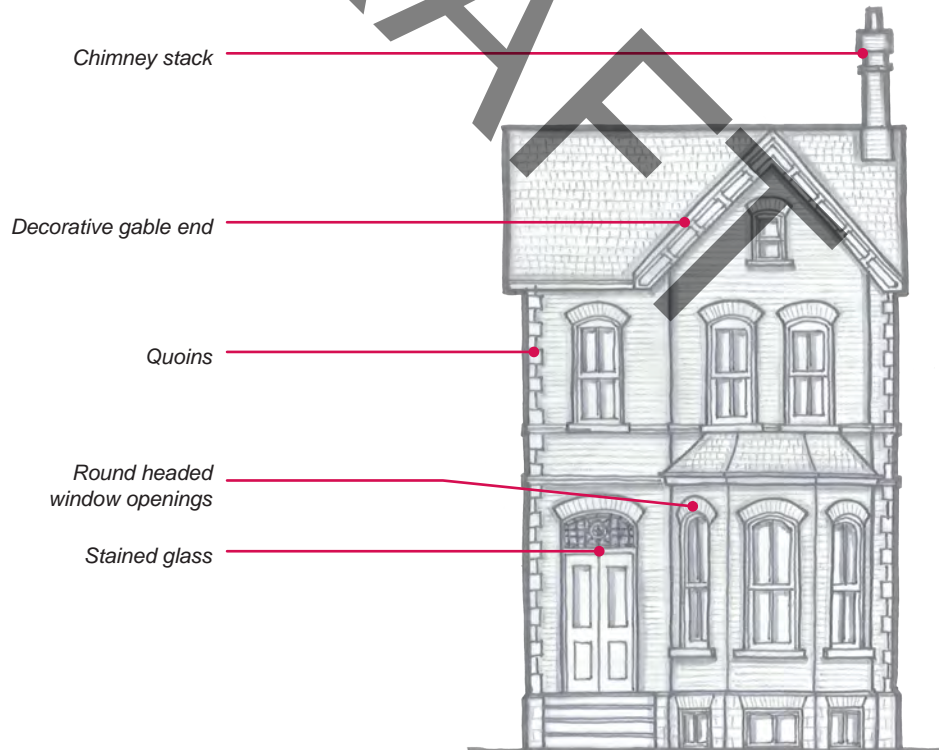

QUEEN ANNE

PERIOD OF POPULARITY: 1870-1910

This style is associated with North America's 'gilded age' when the upper middle class sought to express growing sense of wealth and refinement, with enough rooms to house extended family members and servants. These large and opulent homes were inspired by medieval building principles that sought a return to craftsmanship and were designed to impress.

Hallmarks of the style included eclectic massing with towers and bays, verandas, elaborate woodwork and architectural elements, a mix of materials, and ornate masonry.

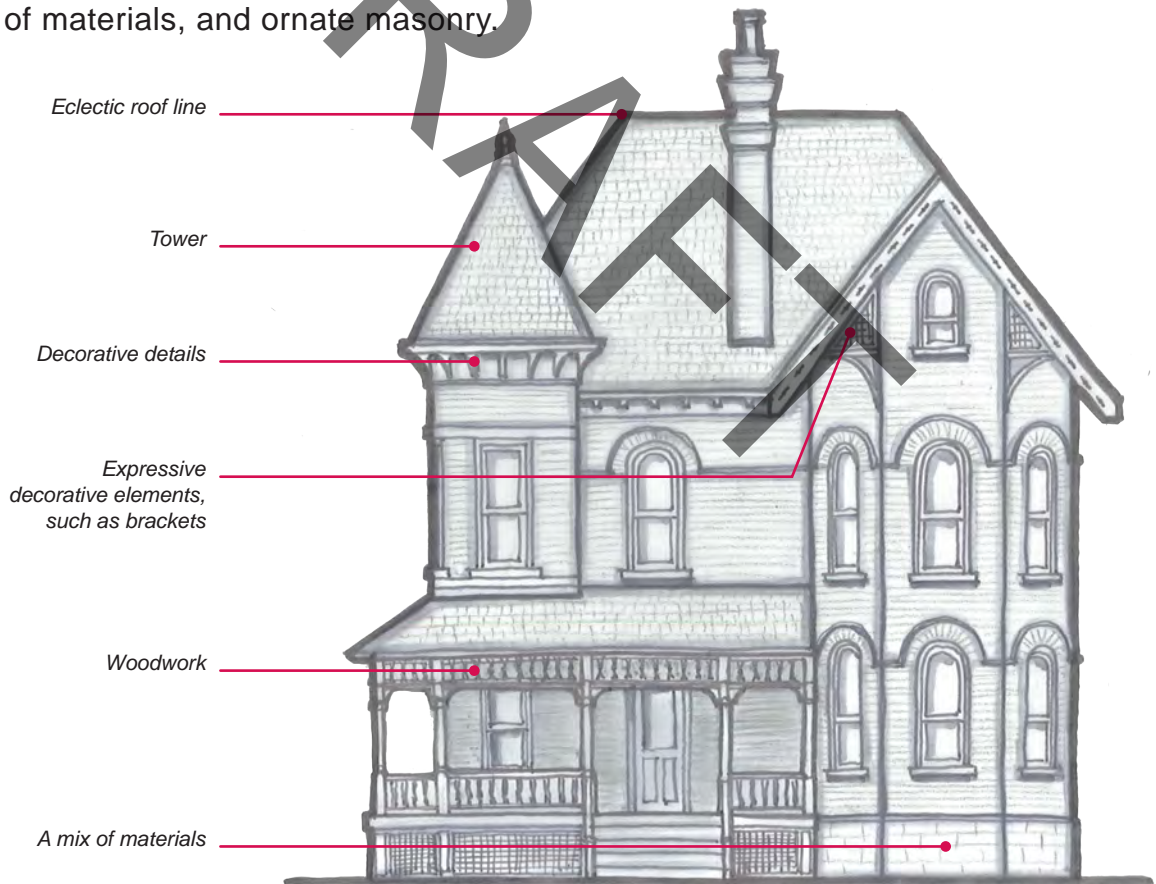

REGENCY

PERIOD OF POPULARITY: 1820-1860

The Regency style is named after the regency of King George IV, a ruler known for his love of leisure. Physically, the style echoed British colonial housing originally designed for tropical British territories in India and the Far East.

In Ontario, Regency style buildings are often one-storey, symmetrical, rectangular plan buildings with a large windows extending almost to the floor. They are often covered by a hipped roof and feature large covered verandahs, distinctive detailing, fanciful trellises and tall decorative chimney stacks.

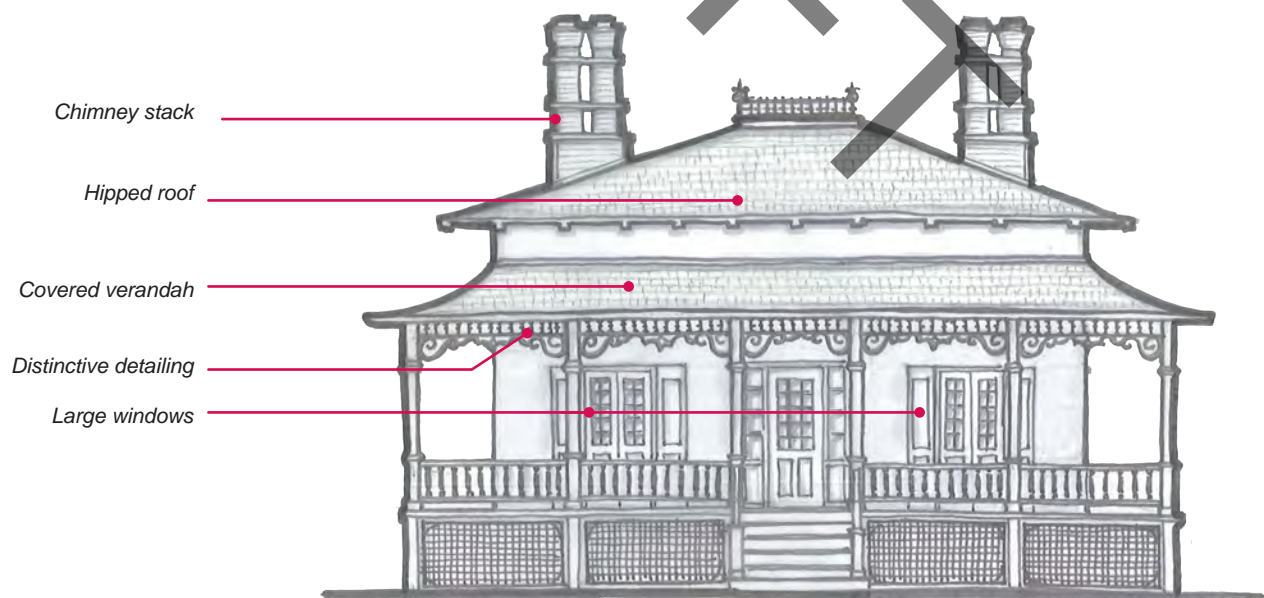

ARTS AND CRAFTS

PERIOD OF POPULARITY: 1890-1940

This architectural style was part of a larger philosophical and artistic movement in reaction to the Industrial Age. It envisioned the house as a living element within the natural environment with a focus on craftsmanship, rather than a sign of the owner's position in society or social pretensions. For example, the grandiose entrance doors of other styles were sometimes replaced by offset or side entrances that allowed for usable space on the front façade for light or gardens. The overall orientation of the house was based on the relationship of the house to the garden and to take advantage of the movement of sun to light and warm rooms. Typical features are irregular architectural composition, use of rough or texture materials and natural colours that reflect the aesthetic orientation of Arts and Crafts movement. The style commonly features small window openings, windowpanes, bay window, and dormers, referencing pre-modern buildings.

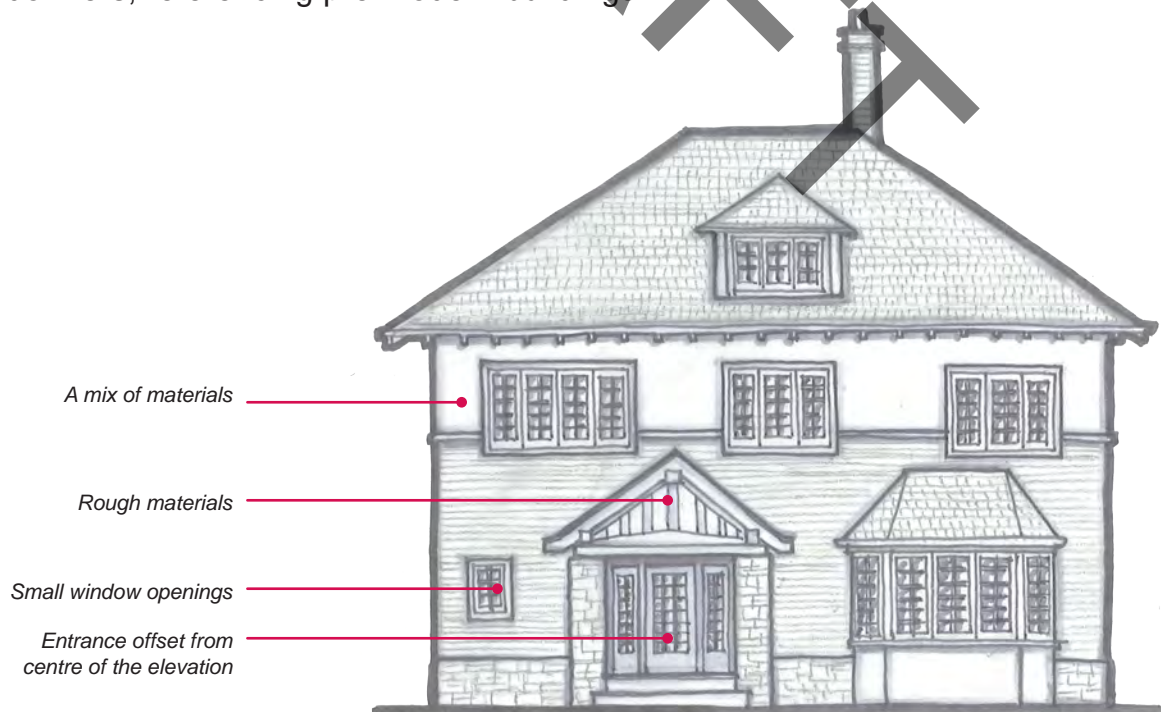

EDWARDIAN

PERIOD OF POPULARITY: 1890S-1930S

Edwardian classicism was one of the most popular building styles in Ontario for several decades after the turn of the century. The Edwardian Classical style in Ontario is a simpler vernacular form of a revival style that looked back to Renaissance architectural models. The popularity of this house type was reinforced by pattern books and plans that could be ordered from catalogues.

Edwardian Classical houses are often characterized by a simple two to two-and-a-half storey square house with a front gable roof. The houses are simple rectangular volumes with symmetrical window and door arrangements; the windows are tall vertical sash windows. There is often a spacious front porch or full length verandah and an off centre doorway. The house often have an exterior brick treatment of brick (with wood shingle sometimes appearing within the front gable) and stripped down classical details.

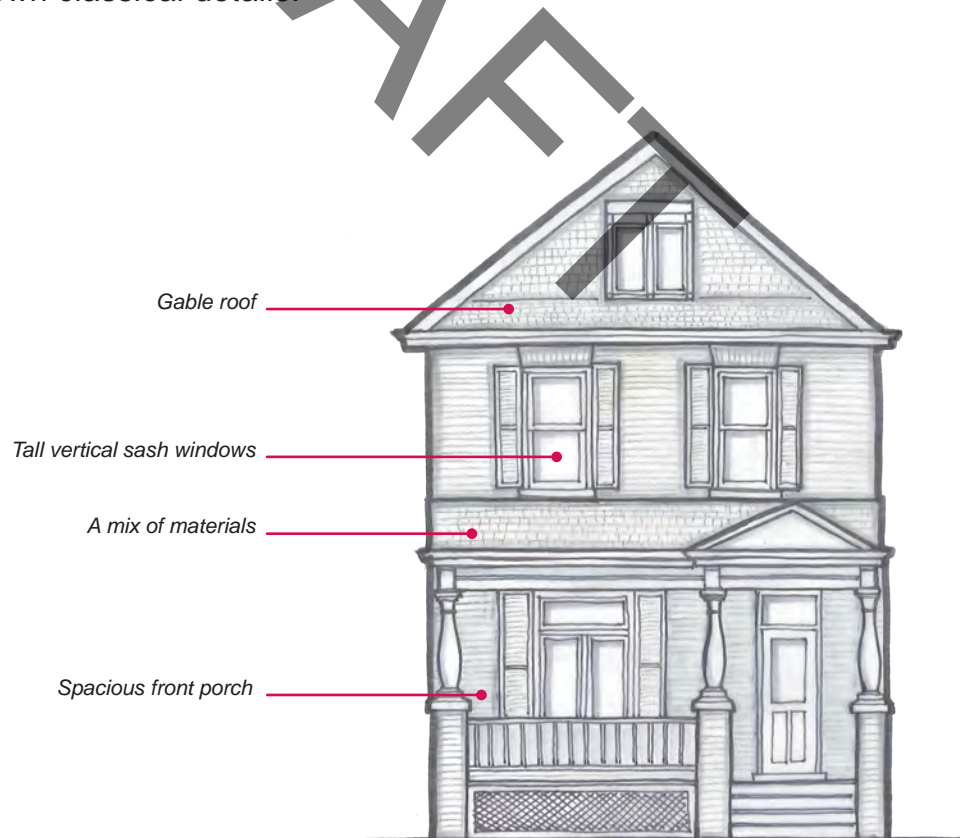

CRAFTSMAN BUNGALOW

PERIOD OF POPULARITY: 1900-1945

The California-based Craftsman Magazine promoted this building style. The style is typically used for one or one-and-a-half storey homes that feature broad, low-pitched roofs constructed with exposed structural framing. A second storey dormer is often inserted above the entrance. Large porches, overhangs, and verandahs link the building to gardens around the building. The style makes use of exposed timber ends, siding, or stonework to add texture and a degree of ornamentation.

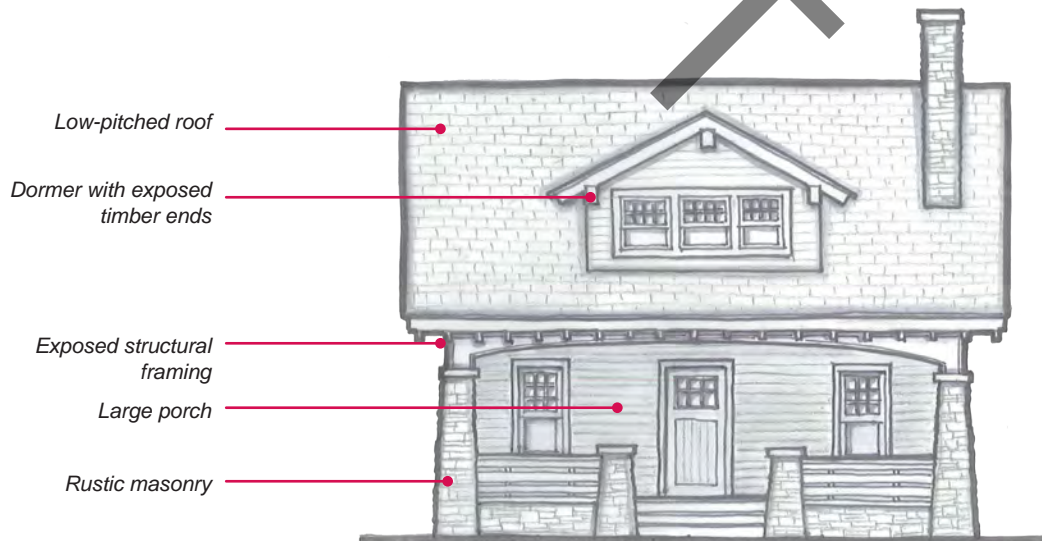

FOUR SQUARE

PERIOD OF POPULARITY: EARLY 1900S

Four Square is a vernacular form of building style named for the typical square footprint layout of the house with equally divided interior spaces. It is often associated with the Edwardian style. Many, but not all, Four Squares were built as 'kit' or mail-order buildings that were shipped to growing towns across North America. The style is usually two or two-and-a-half storeys with a symmetrical front elevation, low pitched hipped roof, full length front porch with square or tapered columns. Windows are found in pairs or are grouped sets of three or four. Dormers and sash windows are also common. The exterior is often clad in brick although clapboard or wooden shingles were also used.

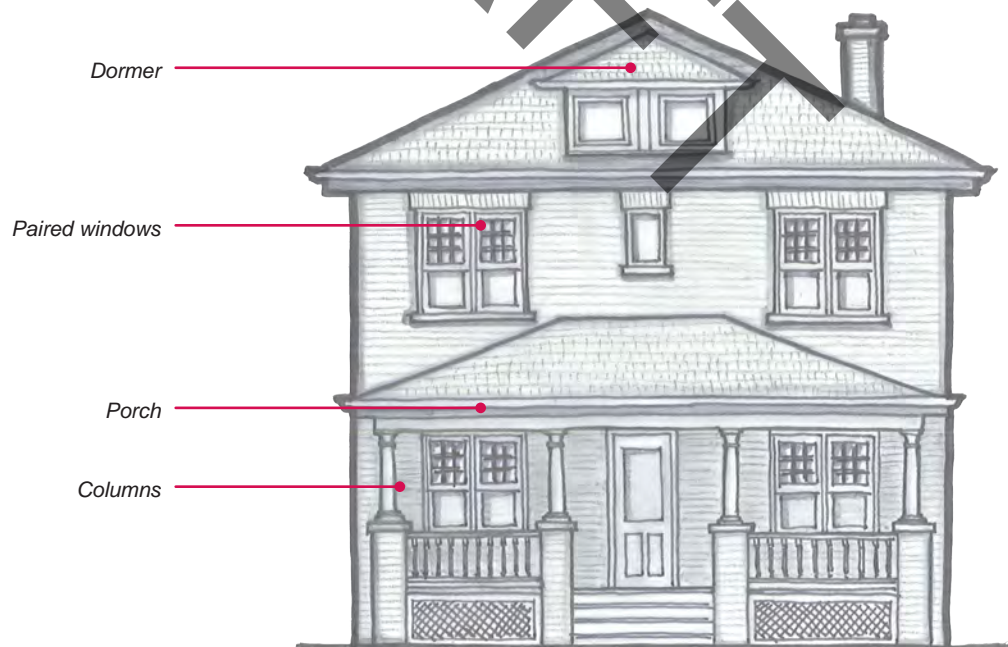

CAPE COD

PERIOD OF POPULARITY: MID-1900S

In Ontario this building style is a mid-20th century revival of the designs of New England pilgrims, who built their homes to withstand the harsh climate and conserve heat. The revival style reflected an interest in simplicity and stability after instability of the Great Depression and the Second World War. These one or one-and-a-half storey structures are characterized by a low, broad frame building with a steep, pitched roof with end gables, a large central chimney and single window dormers. The style features very little ornamentation besides window shutters.

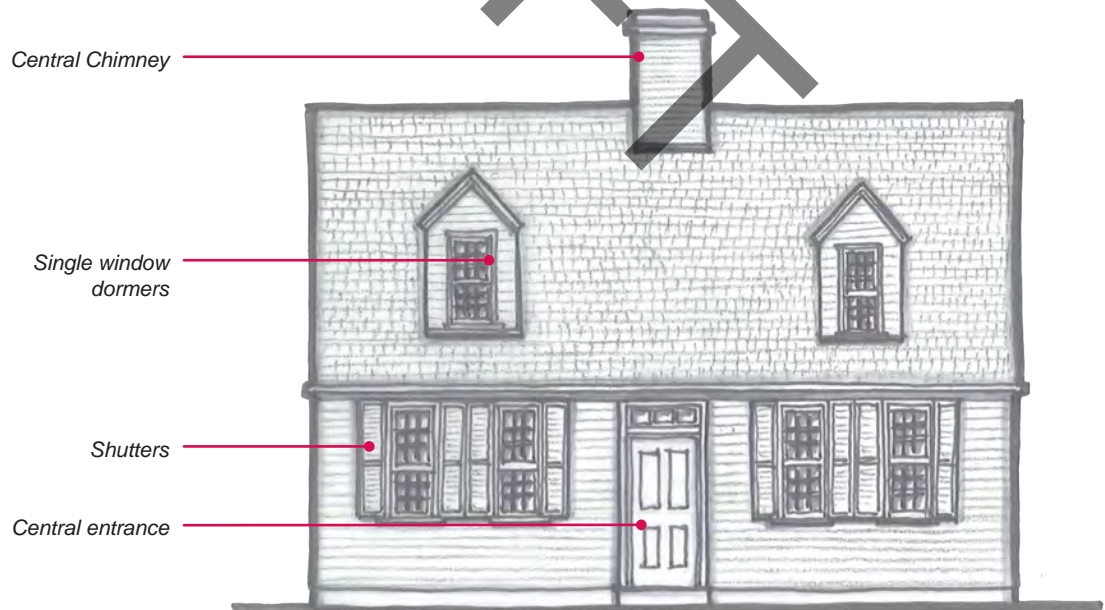

RANCH

PERIOD OF POPULARITY: 1950 - 1980S

The predominant form of construction for the three decades after the Second World War, the ranch building style is a long, low one-storey building with an informal interior plan. Frank Lloyd Wright's Usonian houses are often cited as a contributing factor to the development of this architectural style.

Attributes of the ranch style include: a low-profile, hipped roof; a garage or carport; asphalt shingles; wide eaves with an overhang; usually brick veneer on frame construction; and, large fixed picture windows in the principle rooms. The style allowed the house to be integrated with spacious sites and naturalistic landscaping.

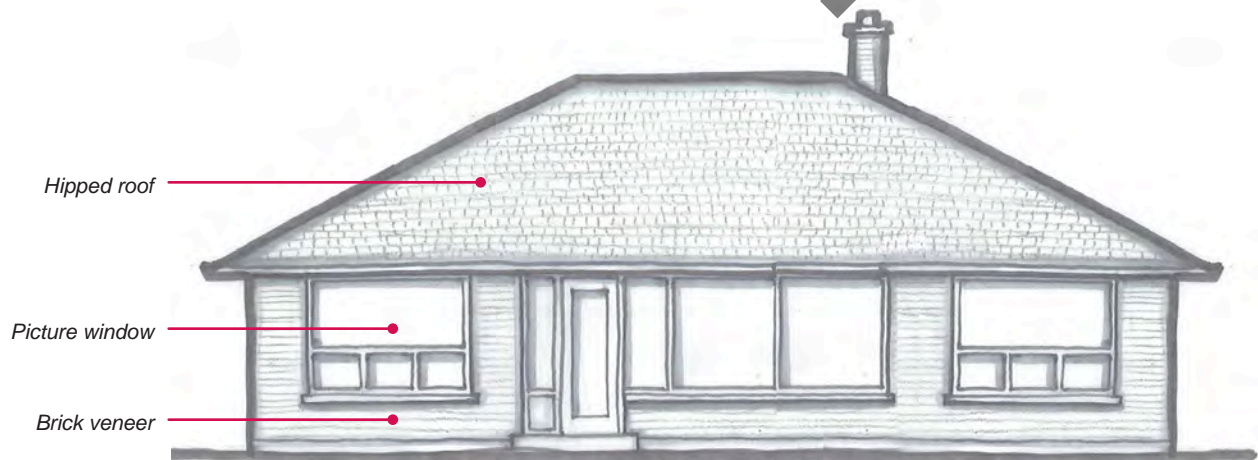

MODERNIST

PERIOD OF POPULARITY: 1950 - PRESENT

This building style represents the shift in lifestyle that occurred after the Second World War where extended families no longer lived together, servants became uncommon, and new, mass-produced appliances simplified the tasks of daily domestic life.

Attributes of the modernist building style include large picture windows, a carport, and an off-centre, sloping roof, typically projecting beyond elevations. Aesthetically, the focus is on sleek lines, geometric forms and patterns, with little ornamentation.

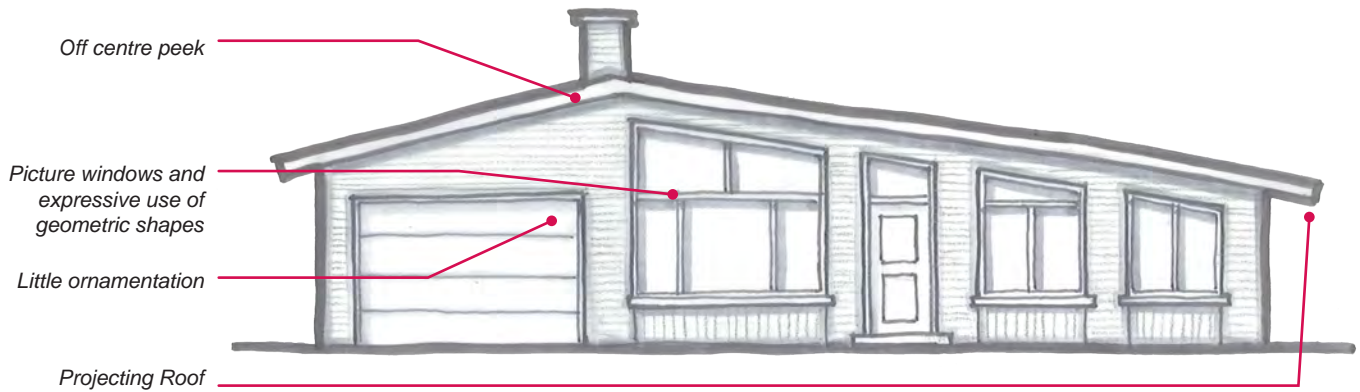

CONTEMPORARY

PERIOD OF POPULARITY: 1980S - PRESENT

Contemporary structures encompass a range of styles and influences. While some contemporary architecture draws primarily from historic references, other examples are clearly contemporary, utilizing current ideas of architectural design, aesthetics, and building technology.

Note: For information on new construction, refer to HCD District Plan Guidelines.

