

Brampton



City of Brampton
Outdoor Master Wayfinding Program
Design Intent Drawings for the Sign Type Array

Design Updates
May 21, 2008

Prepared by

corbindesign

109 East Front Suite 304
Traverse City, MI 49684
231 947.1236

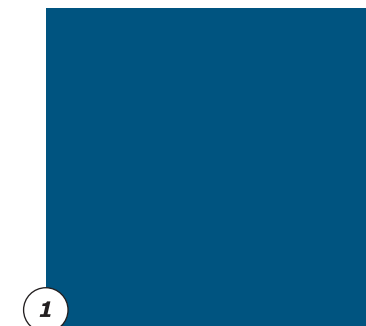

1 Blue
 Paint: Matthews Paint metallic MP22028 satin finish
 Reflective Vinyl: 3M Scotchlite Engineer Grade Blue
 Opaque Vinyl: Avery Dark Royal Blue Metallic A7753-M
 Translucent Vinyl: Avery Twilight Blue A9591-T
 Ink: Pantone 2965

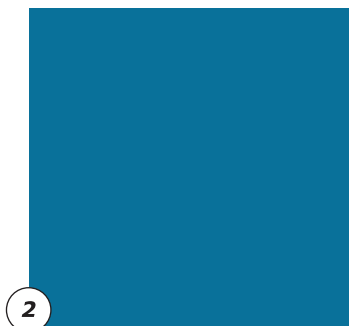

2 Medium Blue
 Paint: Matthews Paint metallic MP21991 satin finish
 Reflective Vinyl: Avery Olympic Blue A7821-R
 Opaque Vinyl: Avery Medium Blue A8555-O
 Ink: Pantone 302 75%



3 Light Blue
 Translucent Vinyl: 3M Frosted Blue Mist Crystal
 Ink: Pantone 302 60%

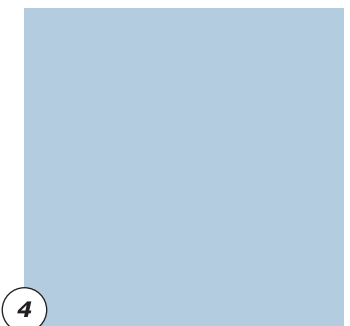

4 Pale Blue
 Paint: Matthews Paint solid MP07490 satin finish
 Opaque Vinyl: Avery Pale Blue A9556-O
 Ink: Pantone 302 20%



5 Maroon
 Paint: Matthews Paint metallic MP22297 satin finish
 Reflective Vinyl: Avery Burgundy A7819-R
 Opaque Vinyl: 3M Scotchcal Burgundy
 Ink: Pantone 209



6 Medium Maroon
 Paint: Matthews Paint metallic MP22299 satin finish
 Ink: Pantone 209 60%

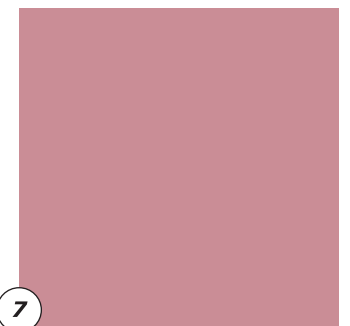

7 Light Maroon
 Translucent Vinyl: 3M Frosted Rose Crystal
 Ink: Pantone 209 40%

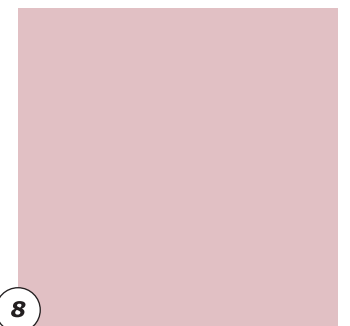

8 Pale Maroon
 Paint: Matthews Paint solid MP00984 satin finish
 Ink: Pantone 209 20%



9 Black
 Paint: Matthews Paint metallic MP19962 satin finish
 Reflective Vinyl: 3M Scotchlite Black
 Opaque Vinyl: 3M Scotchcal Black

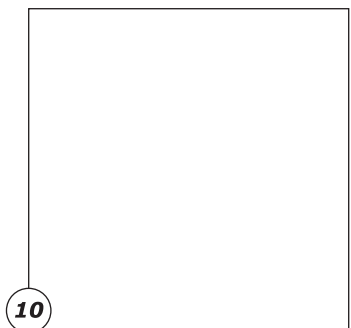

10 White
 Acrylic: Milk-white acrylic
 Paint: Matthews Paint solid White satin finish
 Reflective Vinyl: 3M Scotchlite Engineer Grade White
 High-Intensity Reflective Vinyl: 3M Scotchlite High-Intensity White
 Opaque Vinyl: 3M Scotchcal Matte White



11 Yellow
 Paint: Matthews Paint solid MP07681 satin finish
 Reflective Vinyl: 3M Scotchlite Engineer Grade Yellow
 Opaque Vinyl: 3M Scotchcal Bright Yellow
 Translucent Vinyl: 3M Scotchcal Marigold
 Ink: Pantone 123

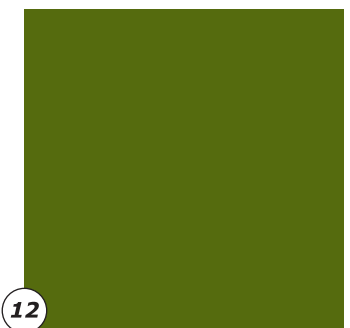

12 Green
 Paint: Matthews Paint solid MP20008 satin finish
 Opaque Vinyl: Avery Sherwood Green A6666-O
 Translucent Vinyl: Avery Army Green A9676-T
 Ink: Pantone 7483C



13 Gold
 Paint: Matthews Paint metallic MP20354 satin finish



14 Bronze
 Paint: Matthews Paint metallic MP20156 satin finish



15 Silver
 Paint: Matthews Paint metallic MP18100 satin finish



16 Red
 Reflective Vinyl: 3M Scotchlite Engineer Grade Red

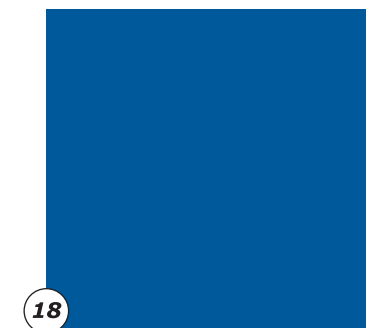

18 MTO Blue
 High-Intensity Reflective Vinyl: 3M Scotchlite High-Intensity Blue

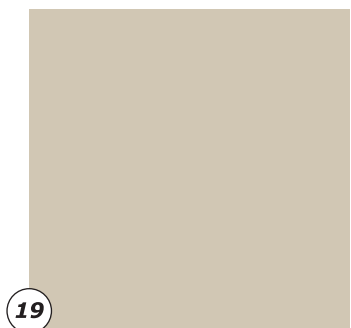

19 Precast Concrete to Match Buff Limestone

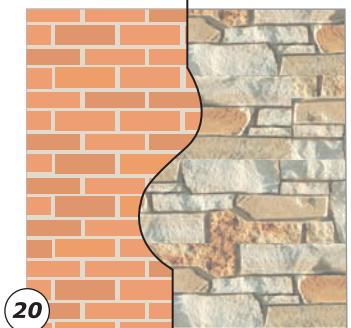

20 Terra Cotta Brick or Rough-cut Fieldstone
 Site-specific masonry base to suit surrounding architecture

Symbols



Left Arrow



Right Arrow



Straight Arrow



Angle Left Arrow



Angle Right Arrow



Parking Symbol



No Parking Symbol



Flower Logo

Scroll Header/Detail Variations



Horizontal Header



Horizontal Header w/ Information



Horizontal Header Low



Vertical Detail Left



Vertical Detail Right



Vertical Detail Right Asymmetric

Art



Single Scroll



Flowery Scroll



Cropped Flower
(reverse side Gx-4)



Sans-serif Typefaces

Aa Bb Cc Dd Ee Ff Gg Hh Ii Jj Kk Ll Mm Nn
Oo Pp Qq Rr Ss Tt Uu Vv Ww Xx Yy Zz 0123456789

ClearviewHwy 1-W
For light letters on a dark background
To purchase font: www.clearviewhwy.com

Aa Bb Cc Dd Ee Ff Gg Hh Ii Jj Kk Ll Mm Nn
Oo Pp Qq Rr Ss Tt Uu Vv Ww Xx Yy Zz 0123456789

ClearviewHwy 2-W
For light letters on a dark background
To purchase font: www.clearviewhwy.com

Aa Bb Cc Dd Ee Ff Gg Hh Ii Jj Kk Ll Mm Nn
Oo Pp Qq Rr Ss Tt Uu Vv Ww Xx Yy Zz
0123456789

ClearviewHwy 4-W
For light letters on a dark background
To purchase font: www.clearviewhwy.com

A B C D E F G H I J K L M N O P Q R S T U V W X Y Z

Arial Narrow Regular

Serif Typeface

Aa Bb Cc Dd Ee Ff Gg Hh Ii Jj Kk Ll Mm Nn
Oo Pp Qq Rr Ss Tt Uu Vv Ww Xx Yy Zz
0123456789

ITC Garamond Light Condensed
For light or dark letters
To purchase font: www.adobe.com/type/

*Aa Bb Cc Dd Ee Ff Gg Hh Ii Jj Kk Ll Mm Nn
Oo Pp Qq Rr Ss Tt Uu Vv Ww Xx Yy Zz
0123456789*

ITC Garamond Book Condensed Italic
For light or dark letters
To purchase font: www.adobe.com/type/

Aa Bb Cc Dd Ee Ff Gg Hh Ii Jj Kk Ll Mm Nn
Oo Pp Qq Rr Ss Tt Uu Vv Ww Xx Yy Zz 0123456789

ClearviewHwy 1-B
For dark letters on a light background
To purchase font: www.clearviewhwy.com

Aa Bb Cc Dd Ee Ff Gg Hh Ii Jj Kk Ll Mm Nn
Oo Pp Qq Rr Ss Tt Uu Vv Ww Xx Yy Zz 0123456789

ClearviewHwy 2-B
For dark letters on a light background
To purchase font: www.clearviewhwy.com

Aa Bb Cc Dd Ee Ff Gg Hh Ii Jj Kk Ll Mm Nn
Oo Pp Qq Rr Ss Tt Uu Vv Ww Xx Yy Zz
0123456789

ClearviewHwy 4-B
For dark letters on a light background
To purchase font: www.clearviewhwy.com

Master Wayfinding Program		Notes	Date	Description	Sign Type Array
City of Brampton Brampton, Ontario	 109 East Front Suite 304 Traverse City, MI 49684 231 947.1236	Use specified fonts; no substitutions are allowed. It is recommended that the Fabricator purchase these fonts. This drawing is design-intent only. Fabricator is responsible for fabrication and overall level of quality. Any changes in design, materials, fabrication method or other details must be approved by the Designer and the City of Brampton, Ontario.	08.28.06 02.07.07 06.20.07 04.14.08 05.21.08	Preliminary Sign Type Array Revisions Final Document Design Standards Update Design Standards Update	Graphic Standards Typography

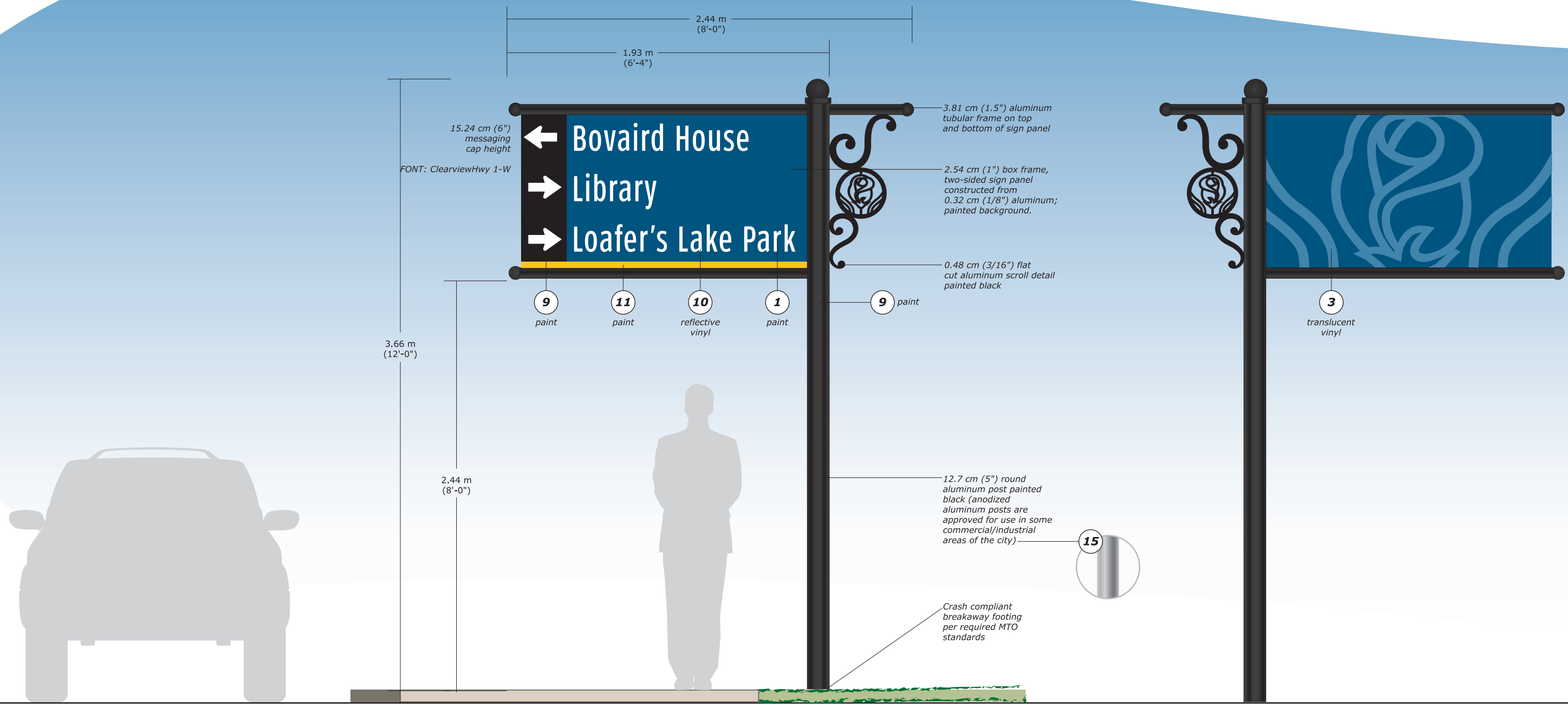

Front View
(Two-Sided Sign)

Back View
(Two-Sided Sign)

Master Wayfinding Program	Scale	Colour Palette	Notes	Date	Description	Sign Type Array
<p>City of Brampton Brampton, Ontario</p>	<p>1.27 cm = 0.3 m (1/2" = 1'0") (on an 11 x 17 sheet)</p>		<p>This drawing is design-intent only. Fabricator is responsible for fabrication and overall level of quality. Any changes in design, materials, fabrication method or other details must be approved by the Designer and the City of Brampton, Ontario.</p>	<p>08.28.06 02.07.07 06.20.07 04.14.08 05.21.08</p>	<p>Preliminary Sign Type Array Revisions Final Document Design Standards Update Design Standards Update</p>	<p>Vehicular Guide large Gx-1 </p>

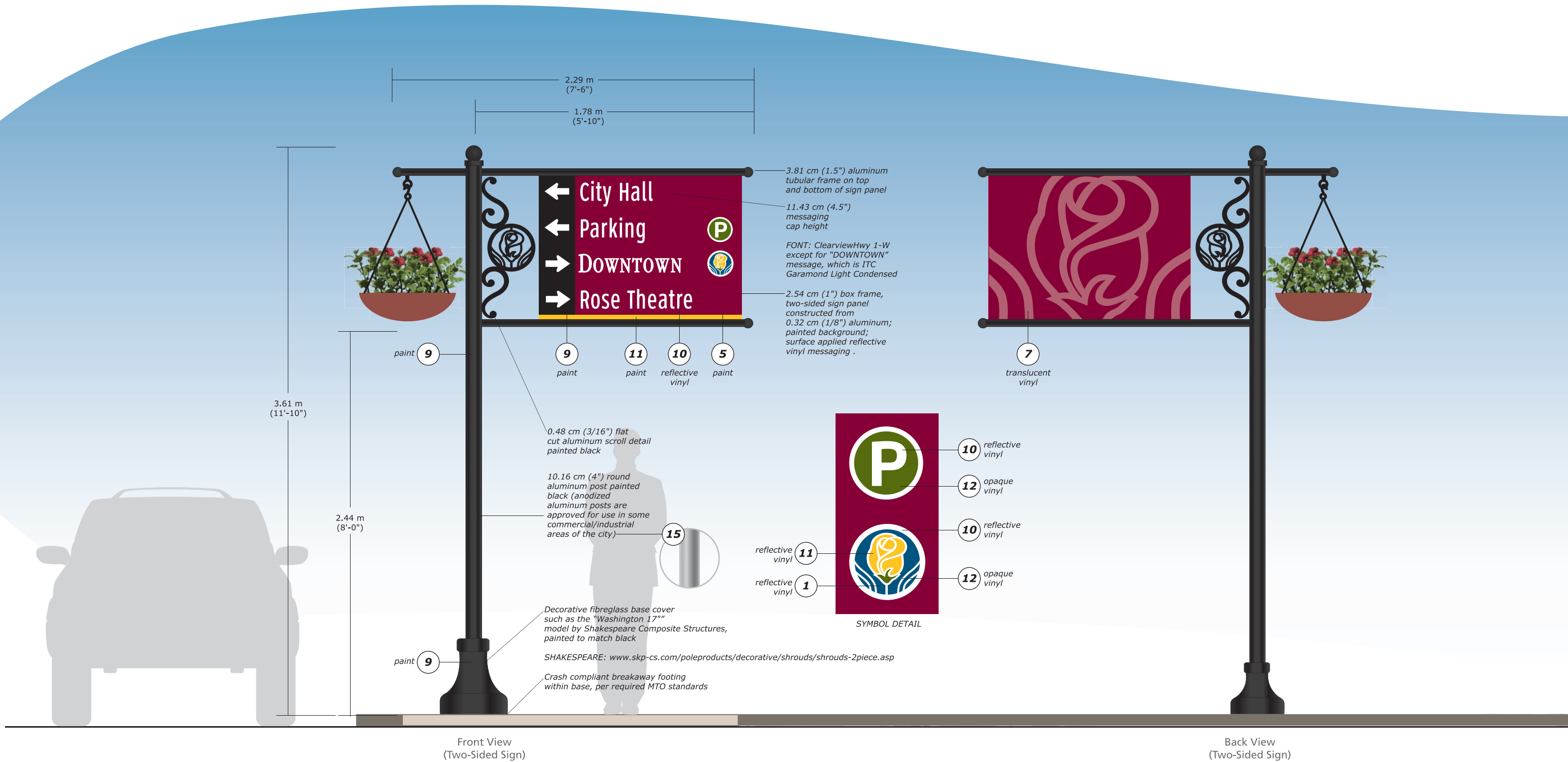

Master Wayfinding Program	Scale	Colour Palette	Notes	Date	Description	Sign Type Array
<p>City of Brampton Brampton, Ontario</p>	<p>1.27 cm = 0.3 m (1/2" = 1'0") (on an 11 x 17 sheet)</p>		<p>This drawing is design-intent only. Fabricator is responsible for fabrication and overall level of quality. Any changes in design, materials, fabrication method or other details must be approved by the Designer and the City of Brampton, Ontario.</p>	<p>08.28.06 02.07.07 06.20.07 04.14.08 05.21.08</p>	<p>Preliminary Sign Type Array Revisions Final Document Design Standards Update Design Standards Update</p>	<p>Vehicular Guide small – Downtown only</p> <p>Gx-2 </p>

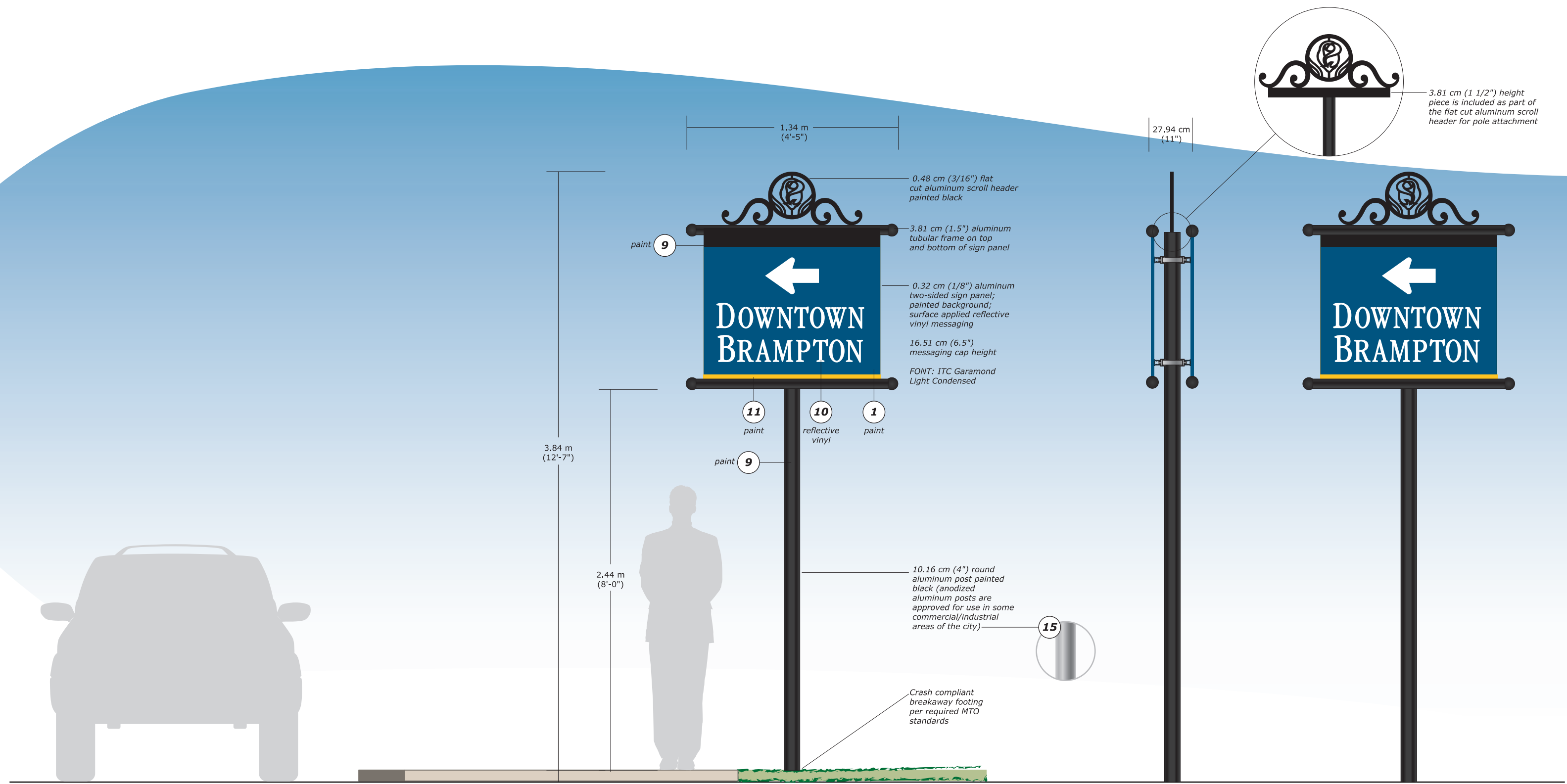

Front View (Two-Sided Sign)

Side View (Two-Sided Sign)

Back View (Two-Sided Sign)

Master Wayfinding Program	Scale	Colour Palette	Notes	Date	Description	Sign Type Array
<p>City of Brampton</p> <p>Brampton, Ontario</p>	<p>1.27 cm = 0.3 m (1/2" = 1'0")</p> <p>(on an 11 x 17 sheet)</p>		<p>This drawing is design-intent only. Fabricator is responsible for fabrication and overall level of quality. Any changes in design, materials, fabrication method or other details must be approved by the Designer and the City of Brampton, Ontario.</p>	<p>08.28.06</p> <p>02.07.07</p> <p>06.20.07</p> <p>04.14.08</p> <p>05.21.08</p>	<p>Preliminary Sign Type Array</p> <p>Revisions</p> <p>Final Document</p> <p>Design Standards Update</p> <p>Design Standards Update</p>	<p>Trailblazer Guide</p> <p>Gx-3</p>

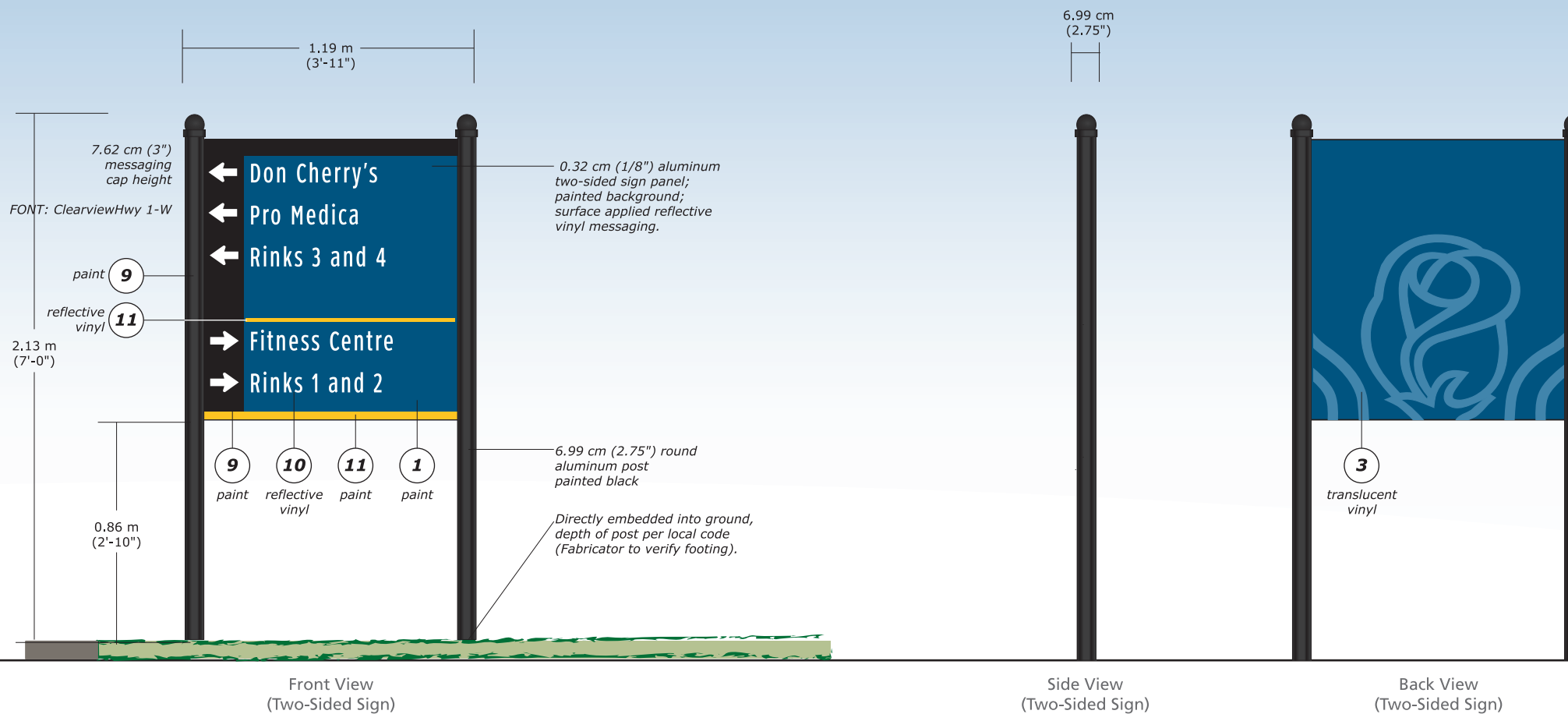
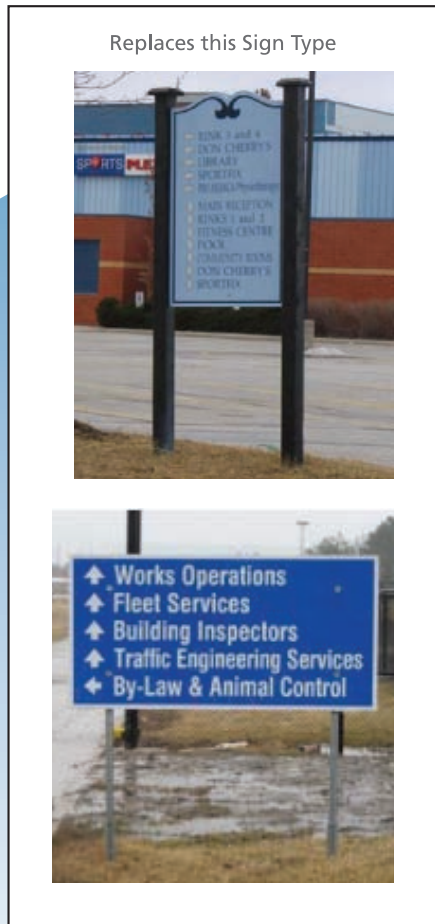

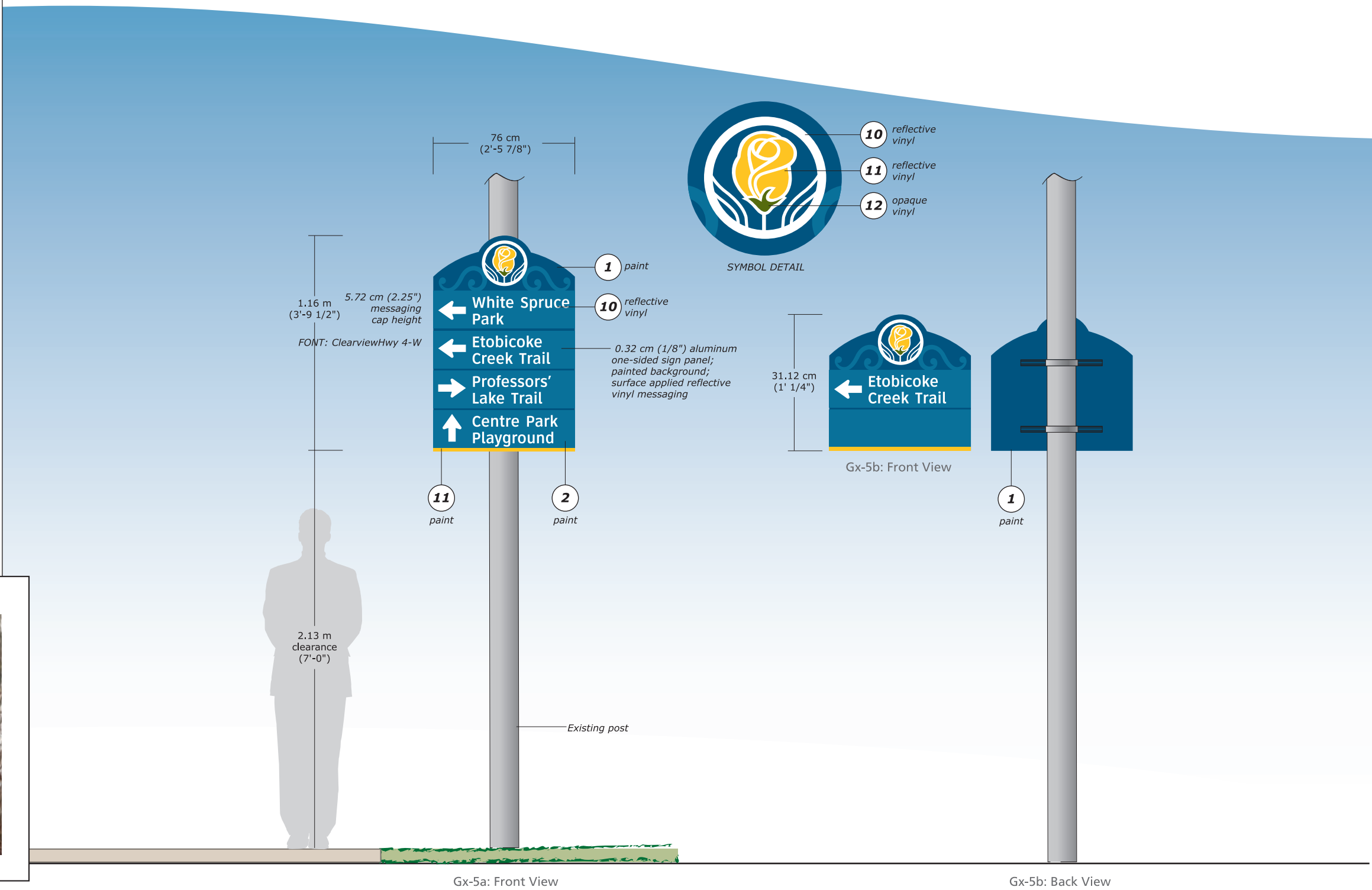
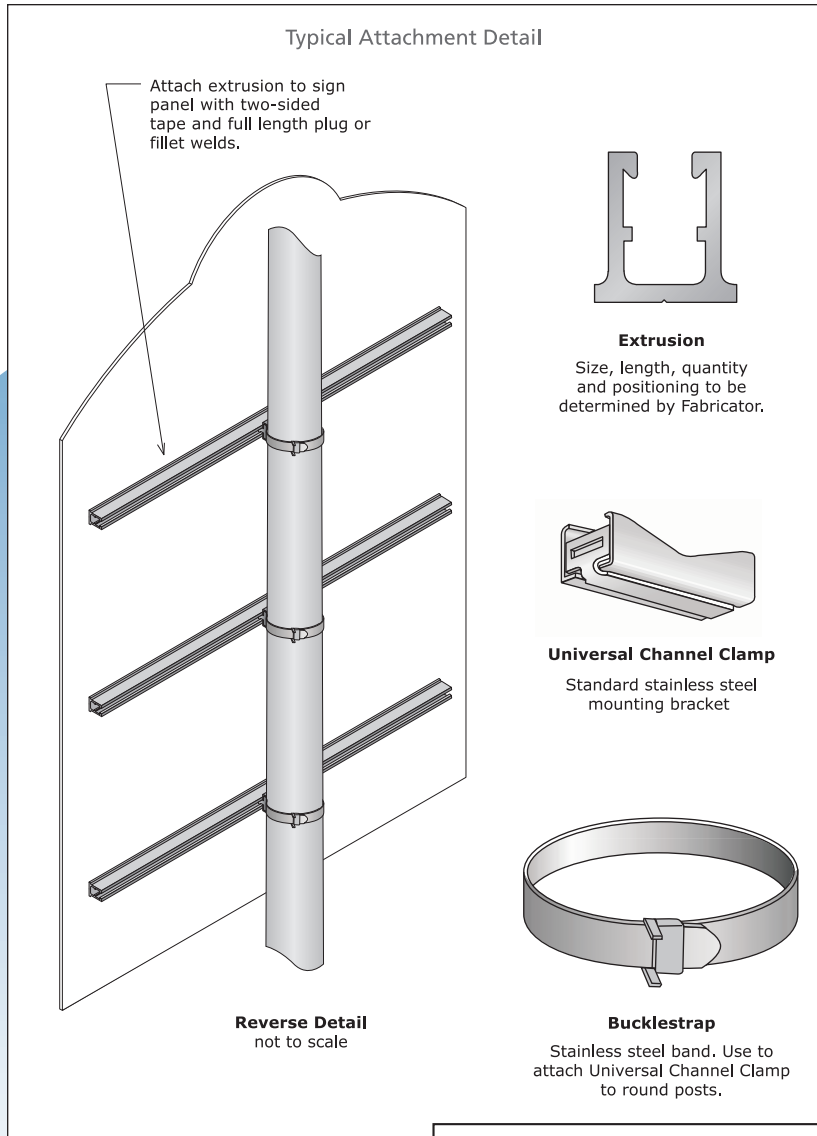

Master Wayfinding Program	Scale	Colour Palette	Notes	Date	Description	Sign Type Array
City of Brampton Brampton, Ontario	1.27 cm = 0.3 m (1/2" = 1'0") (on an 11 x 17 sheet)		This drawing is design-intent only. Fabricator is responsible for fabrication and overall level of quality. Any changes in design, materials, fabrication method or other details must be approved by the Designer and the City of Brampton, Ontario.	08.28.06 02.07.07 06.20.07 04.14.08 05.21.08	Preliminary Sign Type Array Revisions Final Document Design Standards Update Design Standards Update	Trail Guide Gx-5a large (3-4 messages) Gx-5b small (1-2 messages)

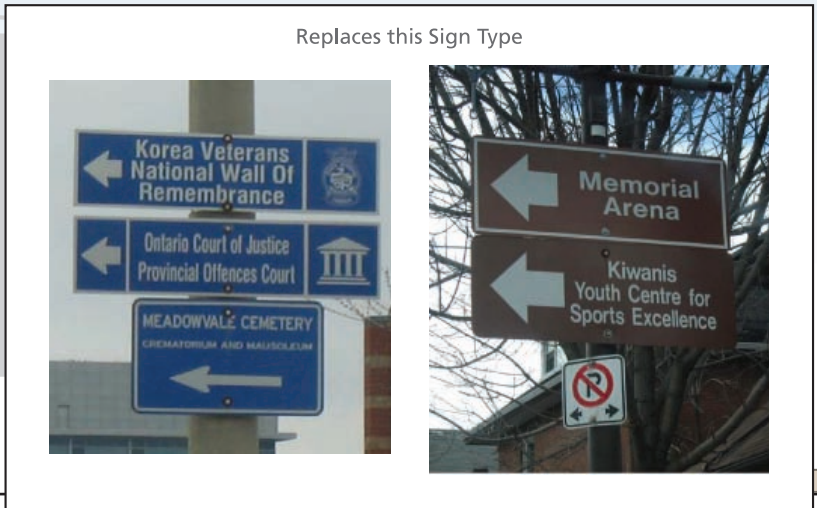
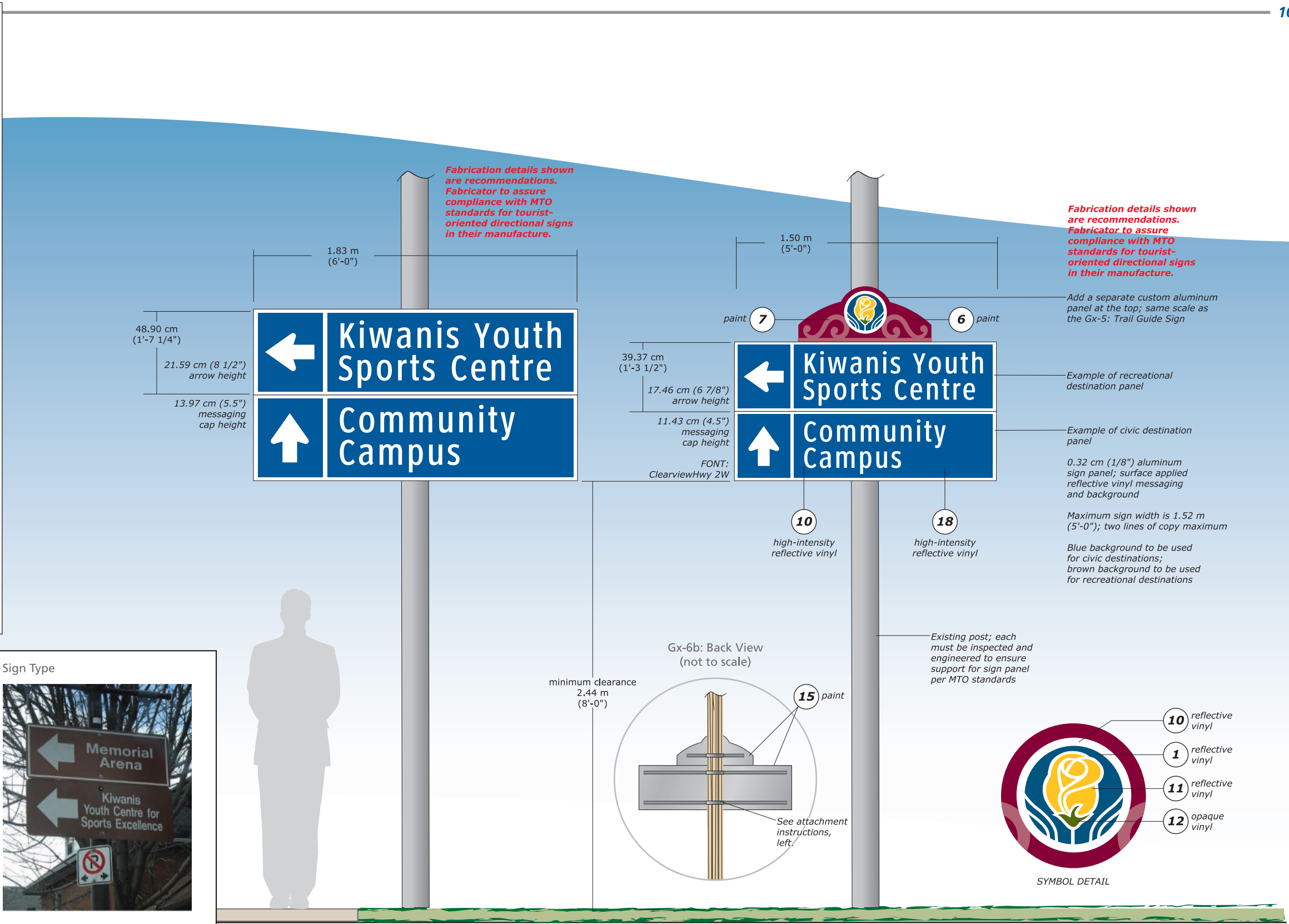
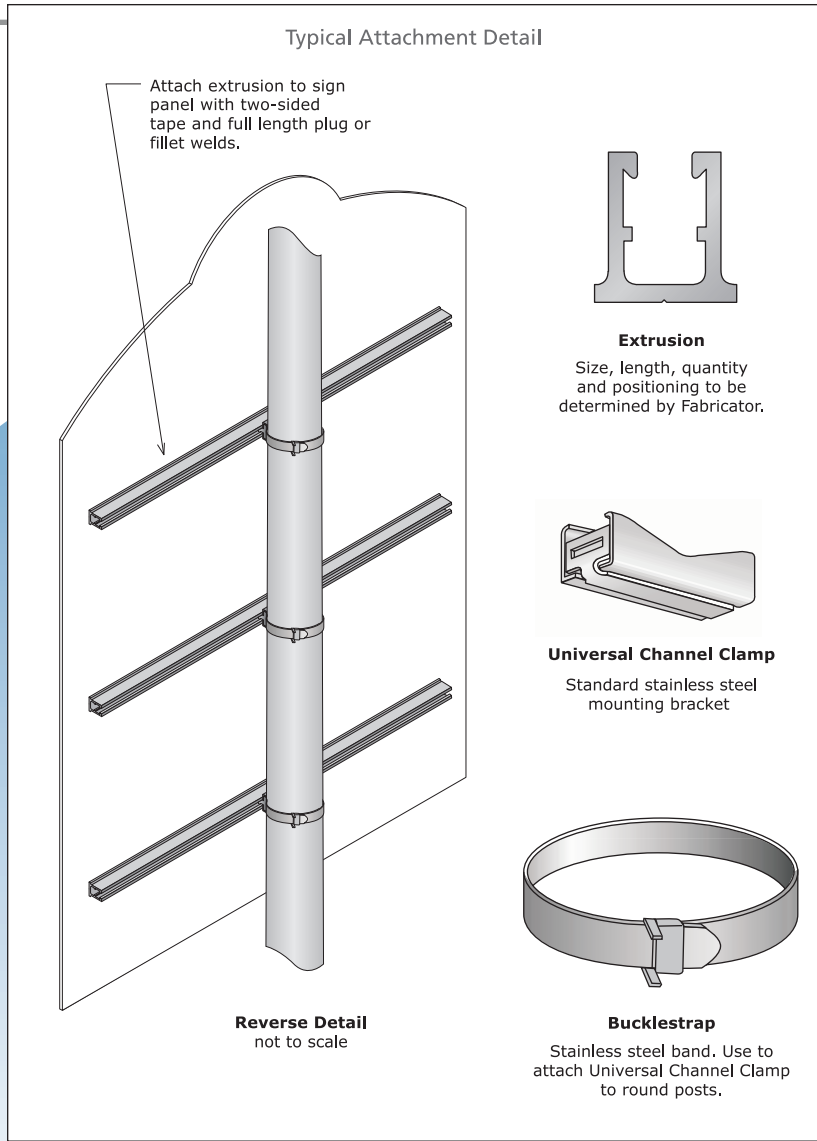

Master Wayfinding Program	Scale	Colour Palette	Notes	Date	Description	Sign Type Array
City of Brampton Brampton, Ontario	1.27 cm = 0.3 m (1/2" = 1'0") (on an 11 x 17 sheet)		This drawing is design-intent only. Fabricator is responsible for fabrication and overall level of quality. Any changes in design, materials, fabrication method or other details must be approved by the Designer and the City of Brampton, Ontario.	08.28.06 02.07.07 06.20.07 04.14.08 05.21.08	Preliminary Sign Type Array Revisions Final Document Design Standards Update Design Standards Update	MTO Guide Gx-6a large Gx-6b small – Downtown only

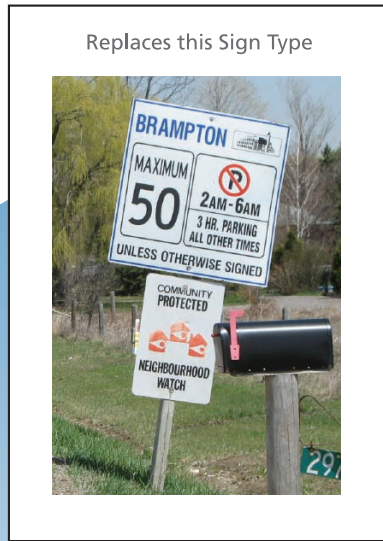

Replaces this Sign Type



SYMBOL DETAIL

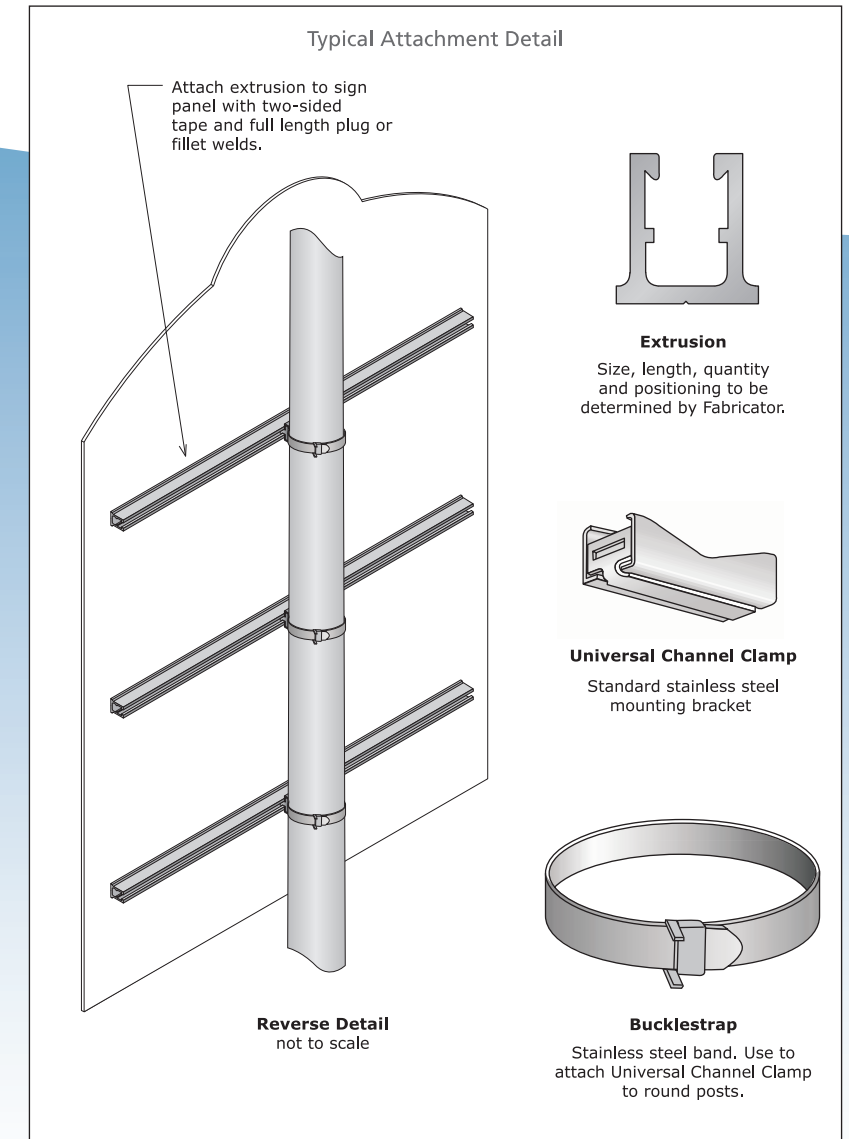
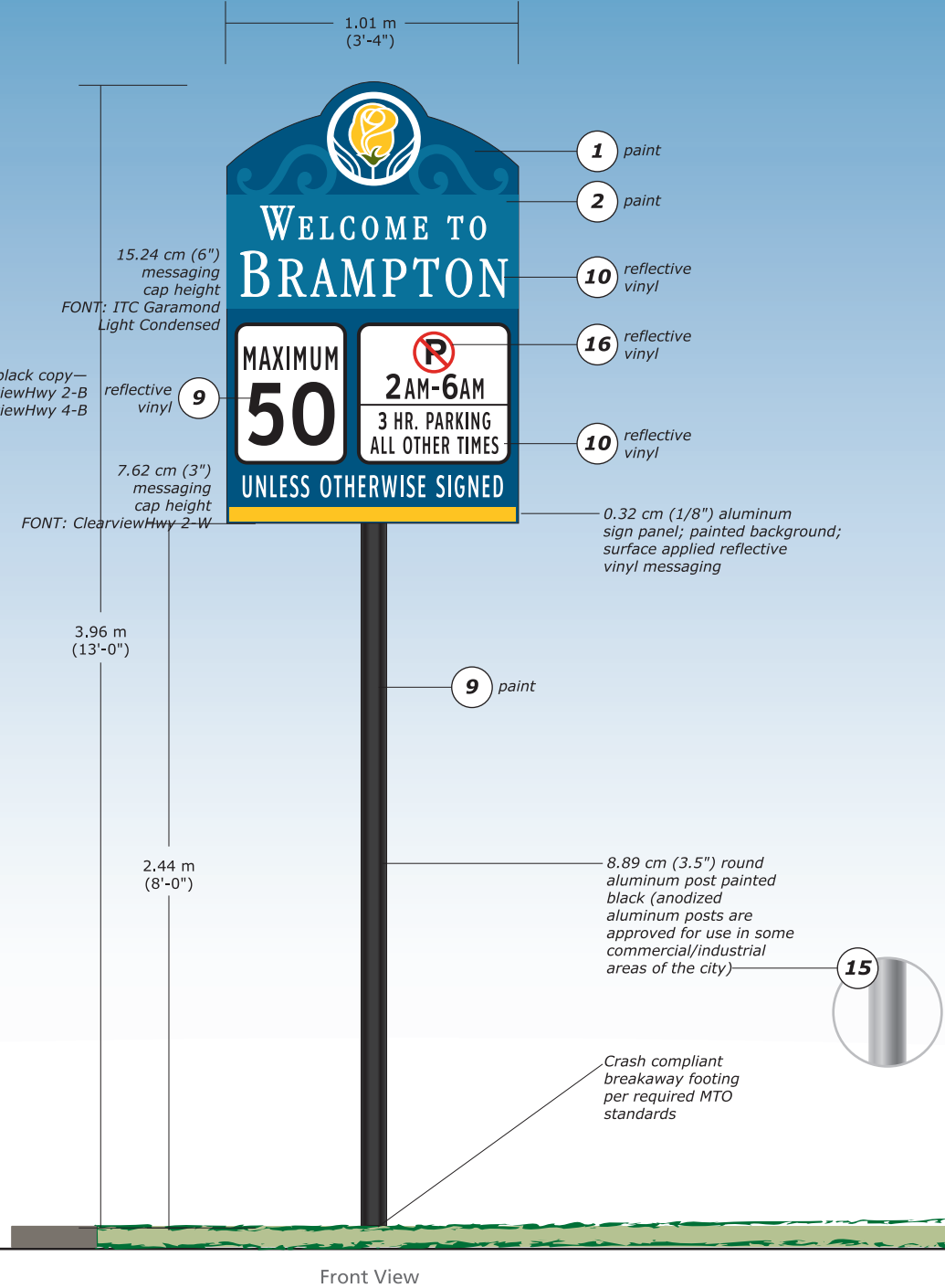

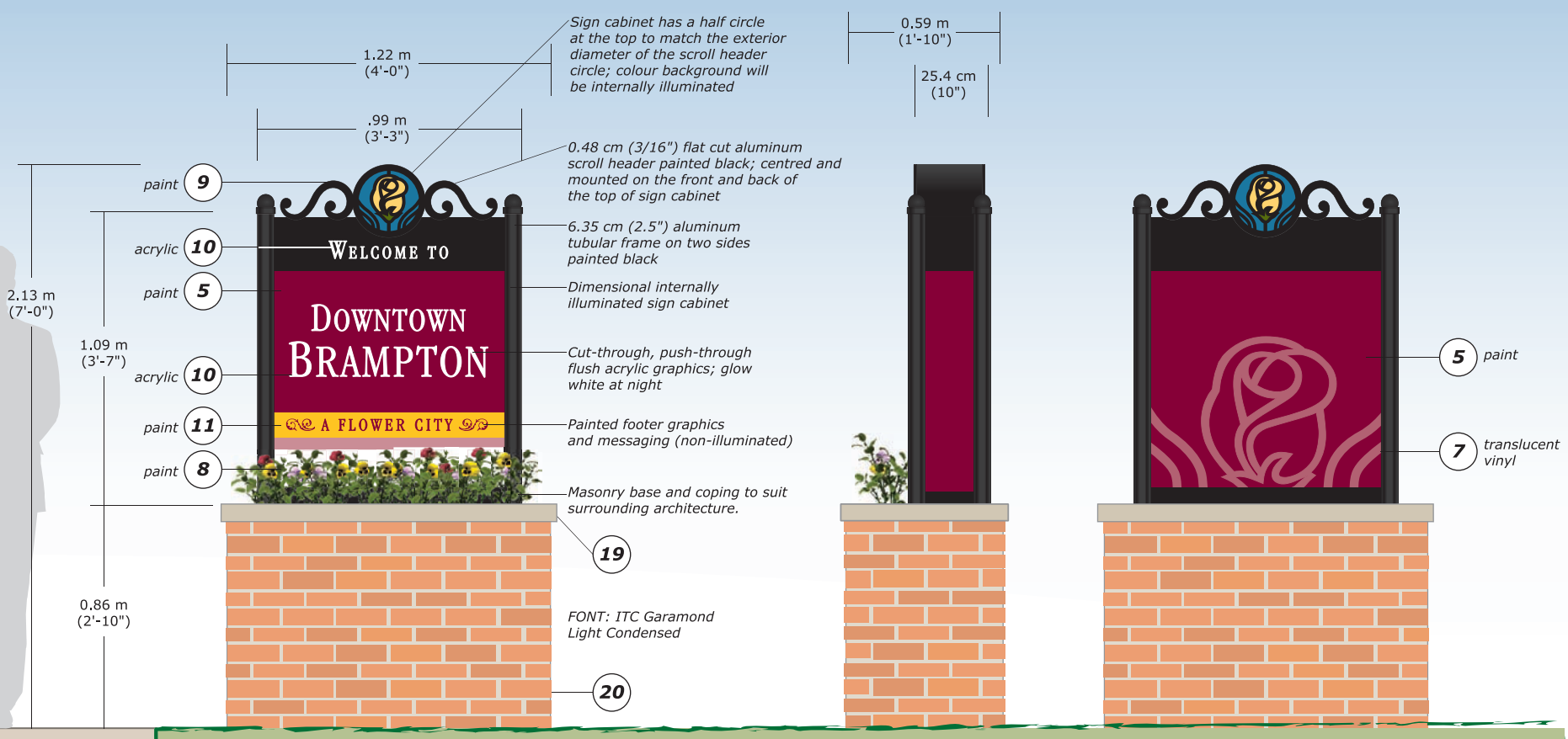
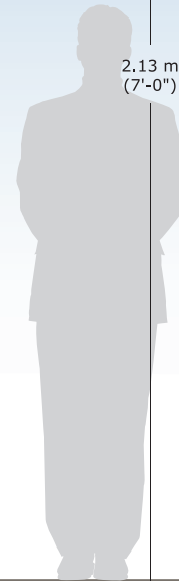
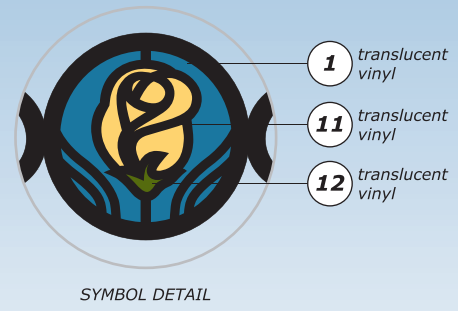
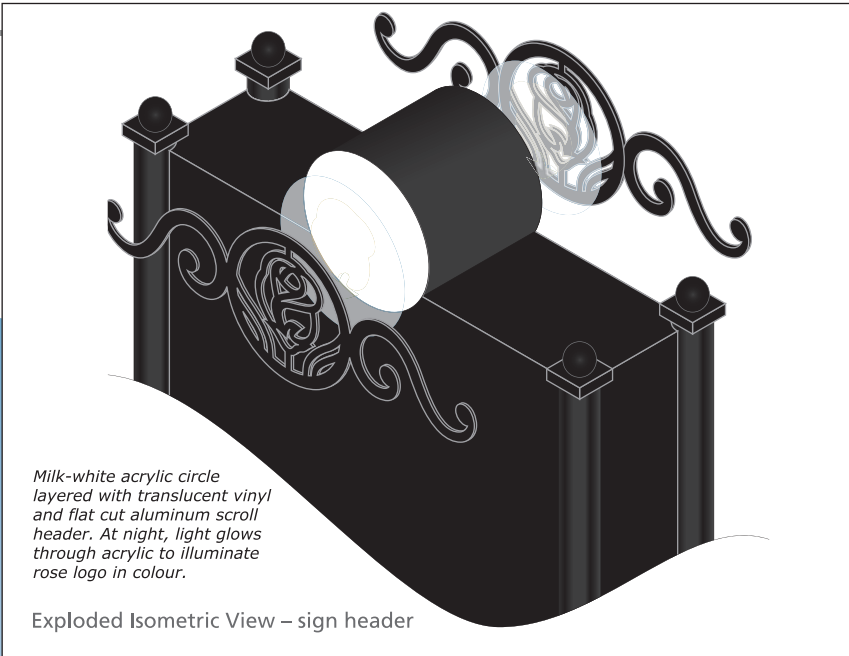

Front View

Side View

Back View

Master Wayfinding Program	Scale	Colour Palette	Notes	Date	Description	Sign Type Array
<p>City of Brampton Brampton, Ontario</p>	<p>1.27 cm = 0.3 m (1/2" = 1'0") (on an 11 x 17 sheet)</p>		<p>This drawing is design-intent only. Fabricator is responsible for fabrication and overall level of quality. Any changes in design, materials, fabrication method or other details must be approved by the Designer and the City of Brampton, Ontario.</p>	<p>08.28.06 02.07.07 06.20.07 04.14.08 05.21.08</p>	<p>Preliminary Sign Type Array Revisions Final Document Design Standards Update Design Standards Update</p>	<p>Downtown ID Masonry, Illuminated Ix-2</p>

Replaces this Sign Type

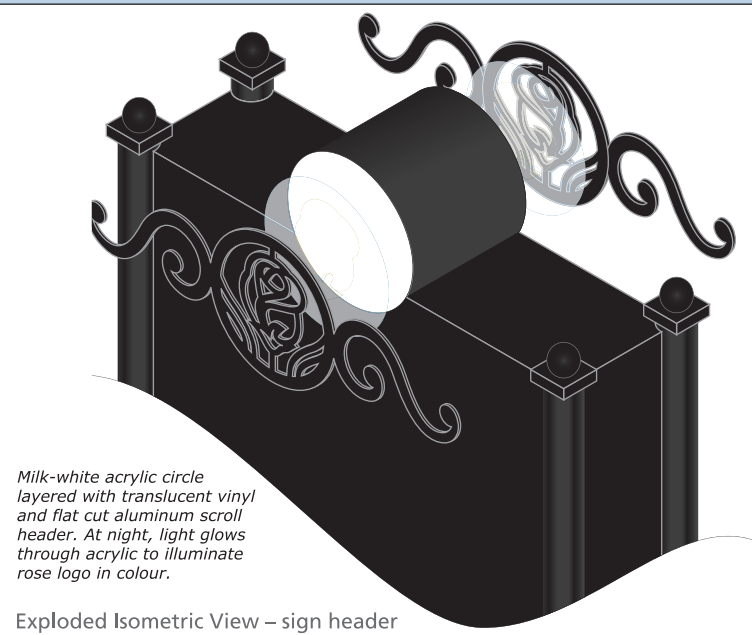

Milk-white acrylic circle layered with translucent vinyl and flat cut aluminum scroll header. At night, light glows through acrylic to illuminate rose logo in colour.

Exploded Isometric View – sign header

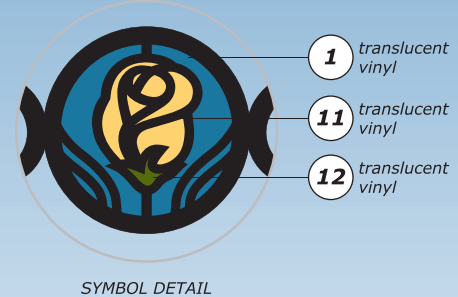
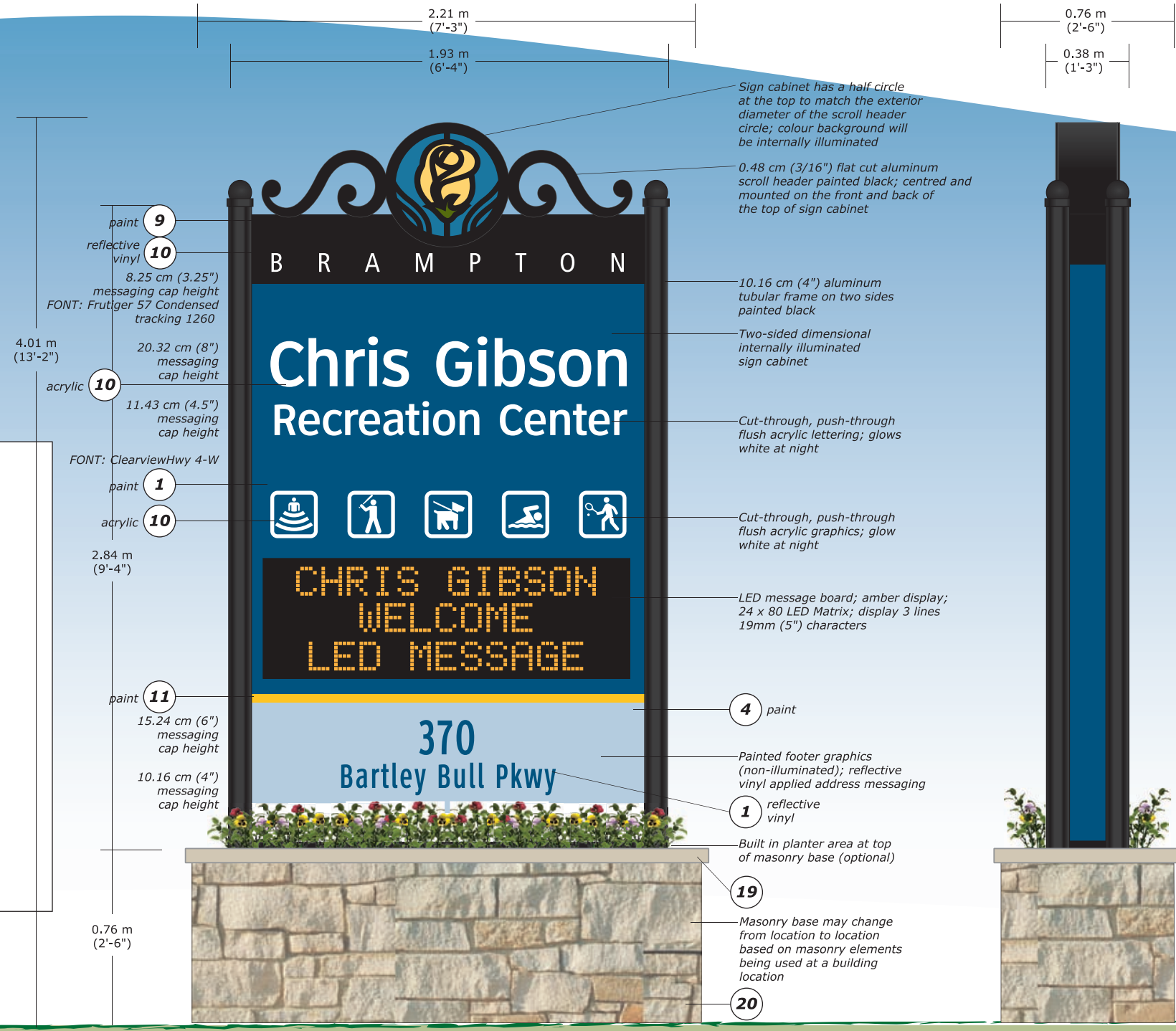

Front & Back Views (Two-Sided Sign)

Side View (Two-Sided Sign)

Master Wayfinding Program	Scale	Colour Palette	Notes	Date	Description	Sign Type Array
<p>City of Brampton</p> <p>Brampton, Ontario</p>	<p>1.27 cm = 0.3 m (1/2" = 1'0")</p> <p>(on an 11 x 17 sheet)</p>		<p>This drawing is design-intent only. Fabricator is responsible for fabrication and overall level of quality. Any changes in design, materials, fabrication method or other details must be approved by the Designer and the City of Brampton, Ontario.</p>	<p>08.28.06</p> <p>02.07.07</p> <p>06.20.07</p> <p>04.14.08</p> <p>05.21.08</p>	<p>Preliminary Sign Type Array</p> <p>Revisions</p> <p>Final Document</p> <p>Design Standards Update</p> <p>Design Standards Update</p>	<p>Facility ID</p> <p>Masonry/LED</p> <p>Ix-3 ✘</p>

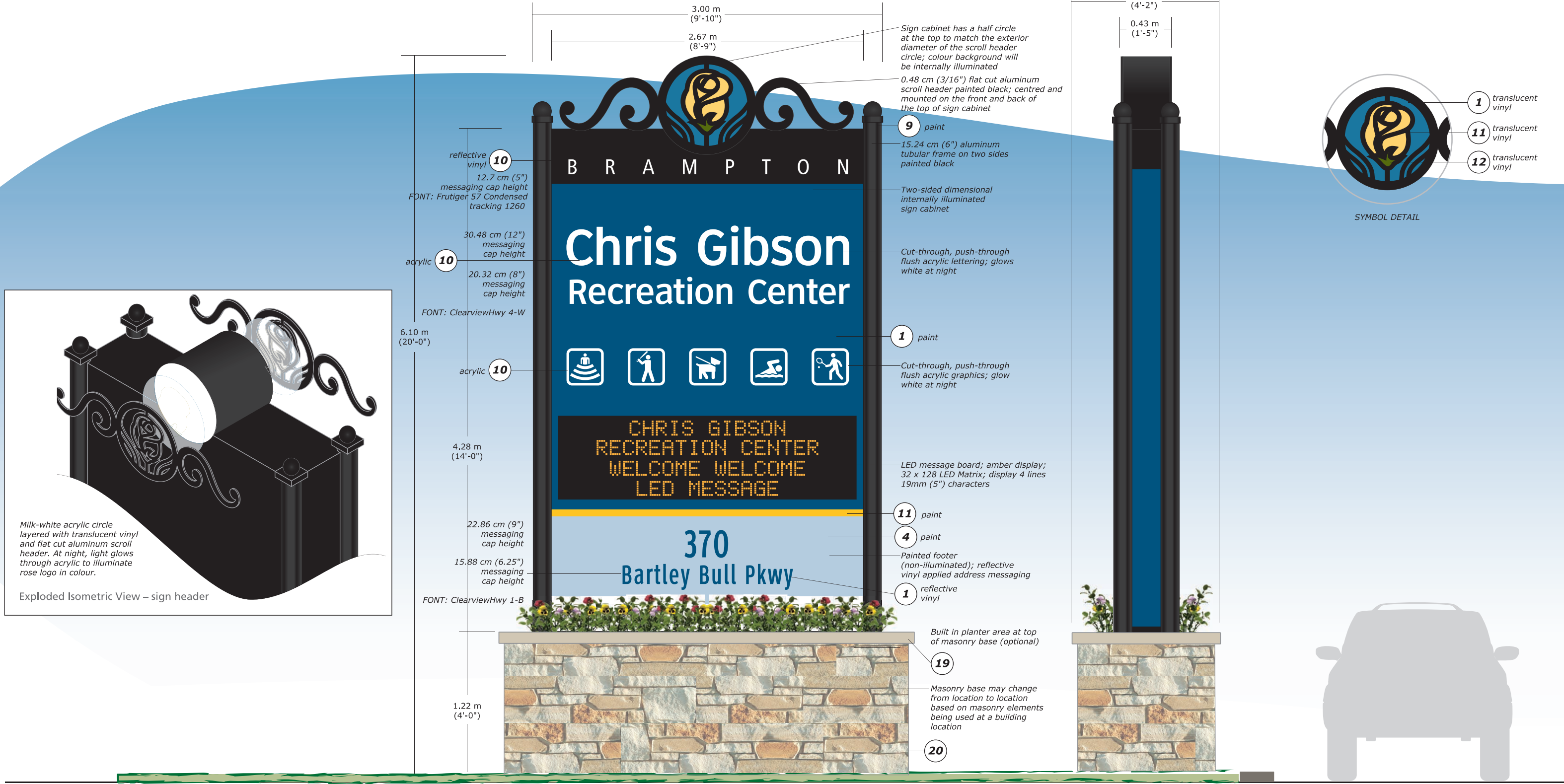

Master Wayfinding Program

City of Brampton
Brampton, Ontario

corbindesign
109 East Front Suite 304
Traverse City, MI 49684
231 947.1236

Scale
0.95 cm = 0.3 m
(3/8" = 1'0")
(on an 11 x 17 sheet)

Colour Palette

1 4 9 10 11 12 19 20

Notes

This drawing is design-intent only. Fabricator is responsible for fabrication and overall level of quality. Any changes in design, materials, fabrication method or other details must be approved by the Designer and the City of Brampton, Ontario.

Date	Description
08.28.06	Preliminary Sign Type Array
02.07.07	Revisions
06.20.07	Final Document
04.14.08	Design Standards Update
05.21.08	Design Standards Update

Sign Type Array

Facility ID, Large Masonry/LED
Ix-3a ✘

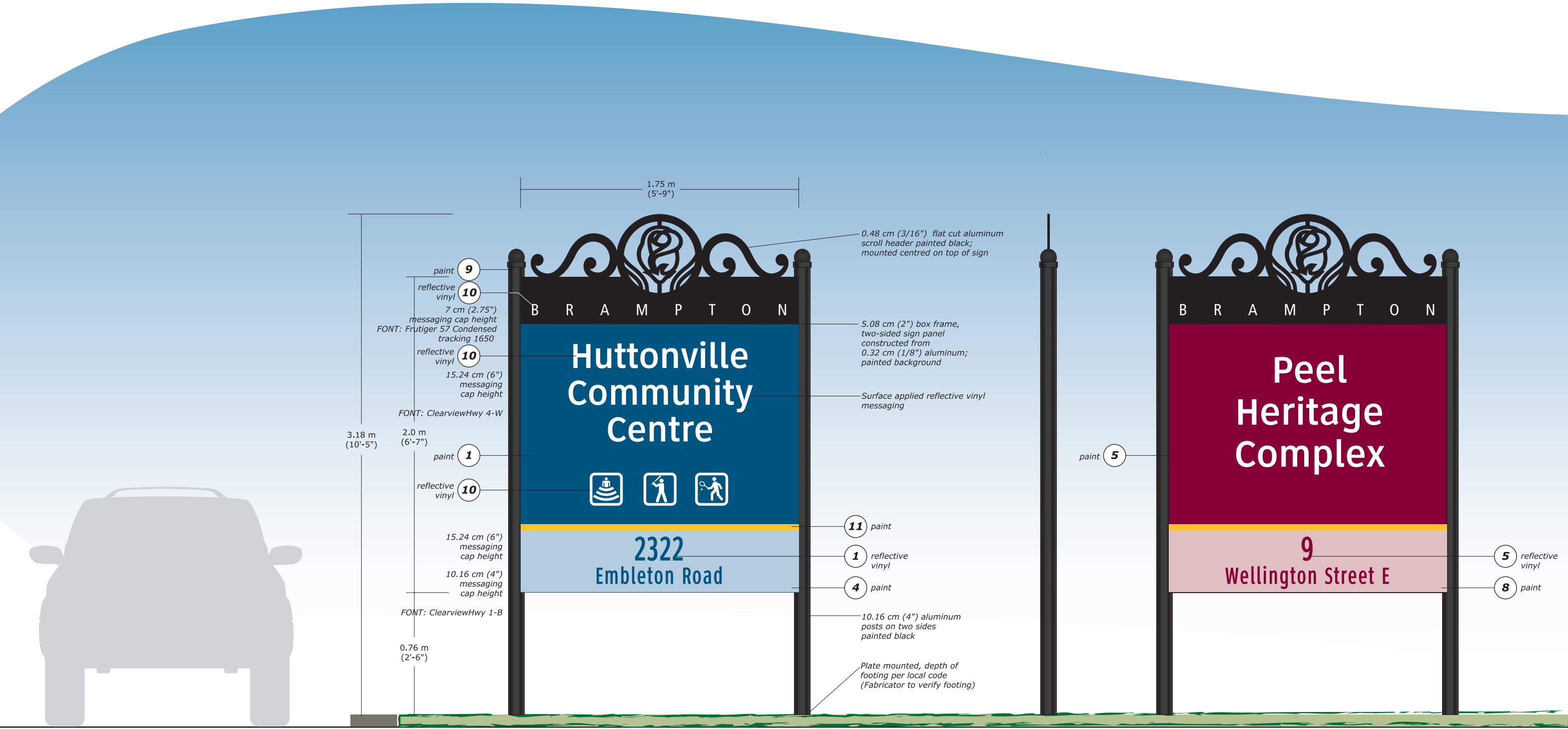

Front View (Back View is identical with reflected scroll header) (Two-Sided Sign)

Side View (Two-Sided Sign)

Front View (Back View is identical with reflected scroll header) (Two-Sided Sign)

Master Wayfinding Program	Scale	Colour Palette	Notes	Date	Description	Sign Type Array
<p>City of Brampton</p> <p>Brampton, Ontario</p>	<p>1.27 cm = 0.3 m (1/2" = 1'0") (on an 11 x 17 sheet)</p>		<p>This drawing is design-intent only. Fabricator is responsible for fabrication and overall level of quality. Any changes in design, materials, fabrication method or other details must be approved by the Designer and the City of Brampton, Ontario.</p>	<p>08.28.06 02.07.07 06.20.07 04.14.08 05.21.08</p>	<p>Preliminary Sign Type Array Revisions Final Document Design Standards Update Design Standards Update</p>	<p>Facility ID post & panel Ix-4 ✗</p>

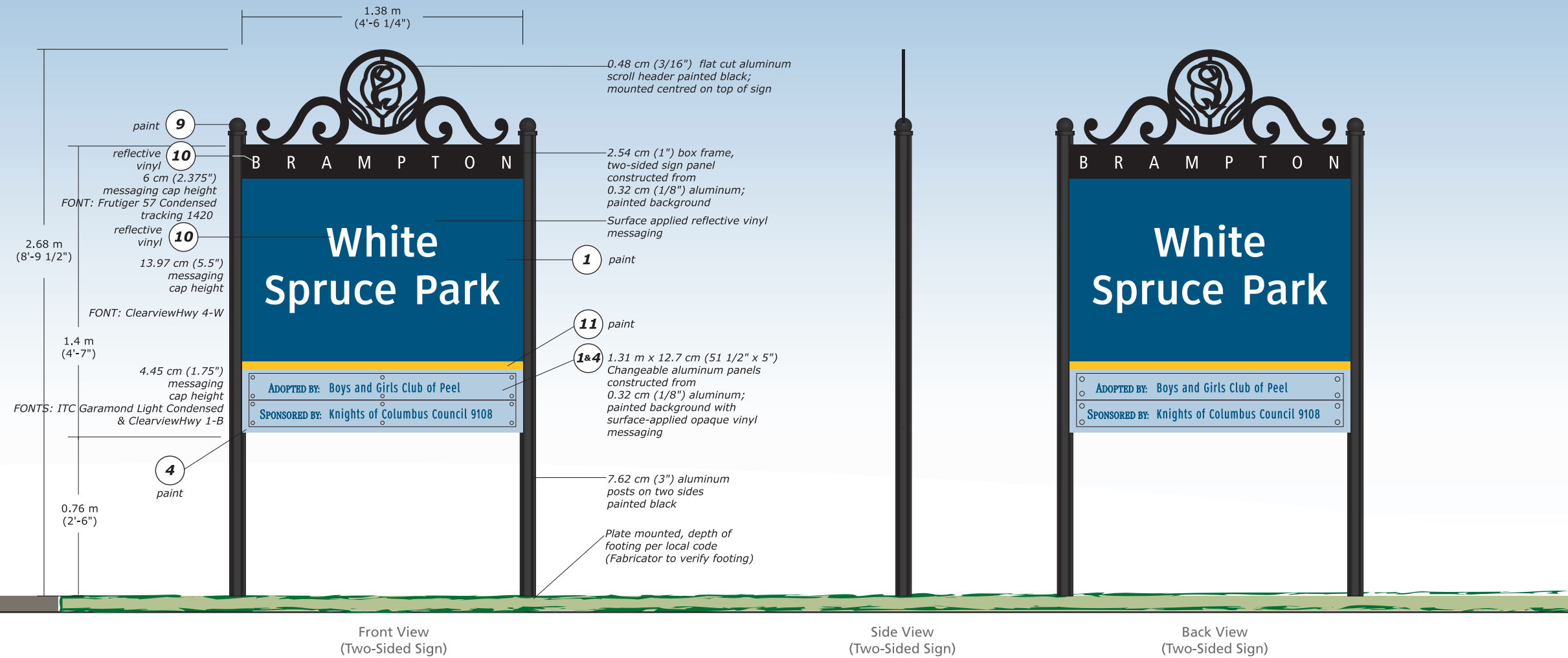

Master Wayfinding Program	Scale	Colour Palette	Notes	Date	Description	Sign Type Array
<p>City of Brampton Brampton, Ontario</p>	<p>1.27 cm = 0.3 m (1/2" = 1'0") (on an 11 x 17 sheet)</p>		<p>This drawing is design-intent only. Fabricator is responsible for fabrication and overall level of quality. Any changes in design, materials, fabrication method or other details must be approved by the Designer and the City of Brampton, Ontario.</p>	<p>08.28.06 02.07.07 06.20.07 04.14.08 05.21.08</p>	<p>Preliminary Sign Type Array Revisions Final Document Design Standards Update Design Standards Update</p>	<p>Park ID post & panel Ix-5 ◆</p>

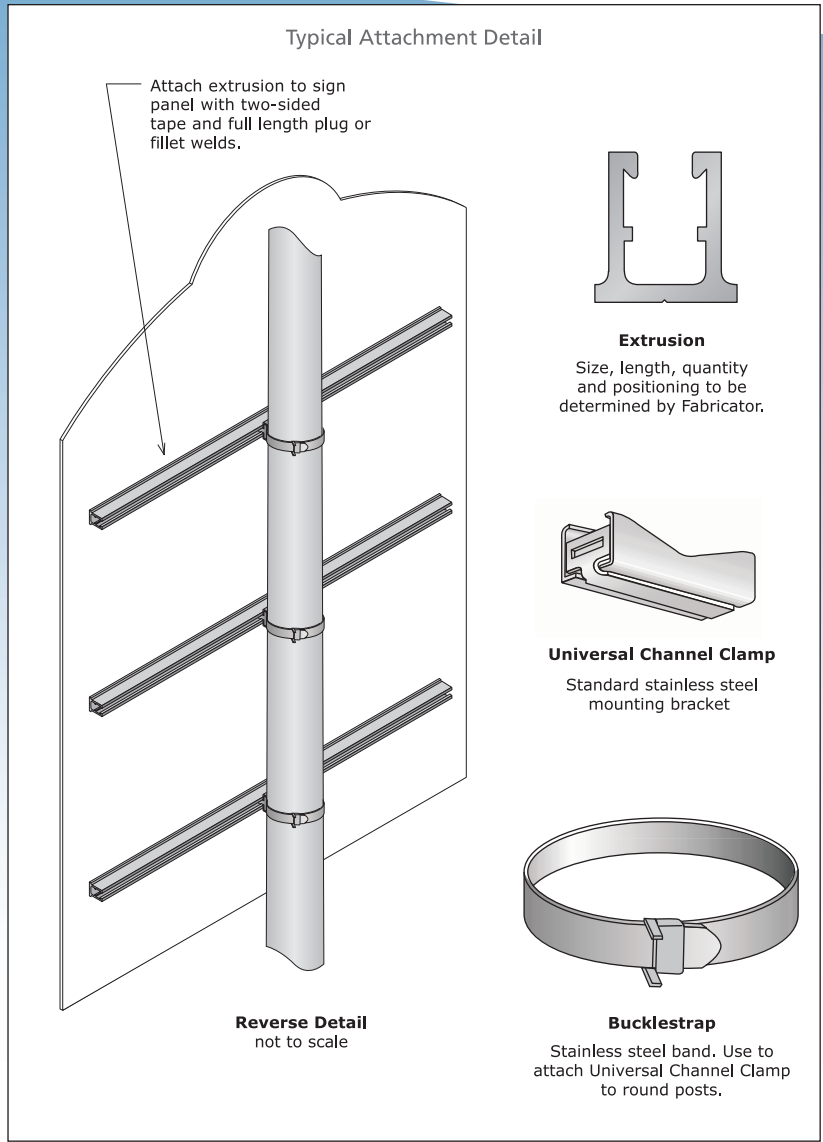
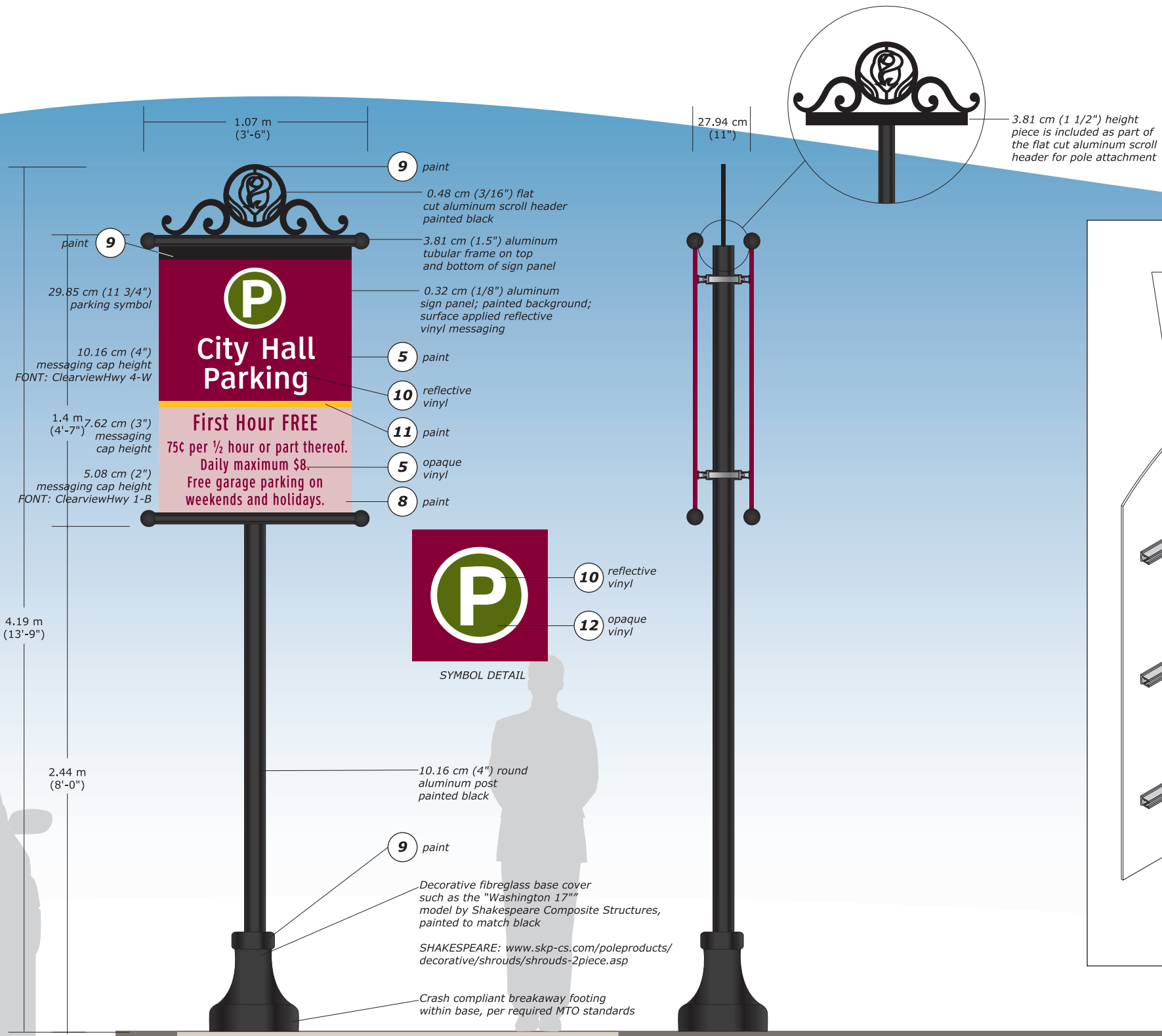
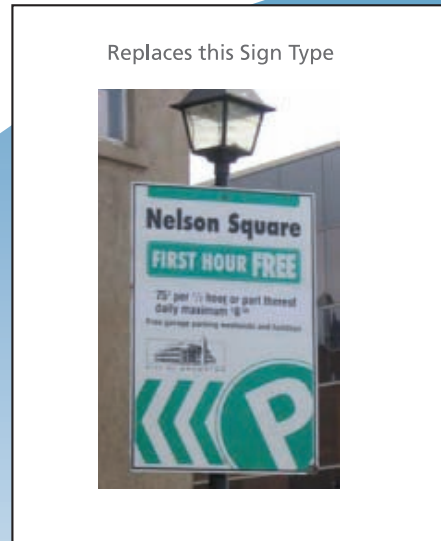

Front View (Back View is identical with reflected scroll header) (Two-Sided Sign)

Side View (Two-Sided Sign)

Master Wayfinding Program	Scale	Colour Palette	Notes	Date	Description	Sign Type Array
City of Brampton Brampton, Ontario	1.27 cm = 0.3 m (1/2" = 1'0") (on an 11 x 17 sheet)		This drawing is design-intent only. Fabricator is responsible for fabrication and overall level of quality. Any changes in design, materials, fabrication method or other details must be approved by the Designer and the City of Brampton, Ontario.	08.28.06 02.07.07 06.20.07 04.14.08 05.21.08	Preliminary Sign Type Array Revisions Final Document Design Standards Update Design Standards Update	Parking ID post & panel Ix-6

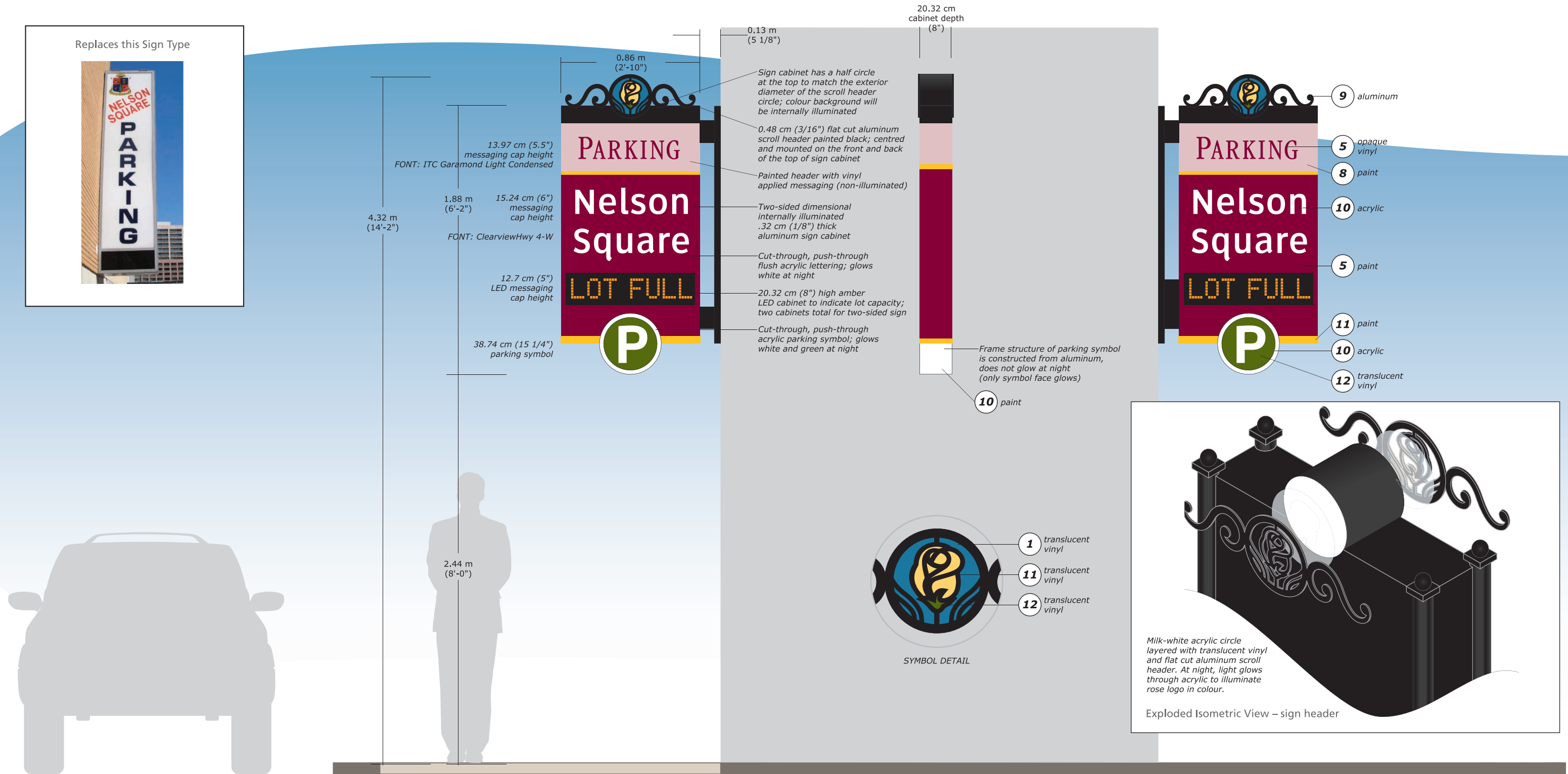
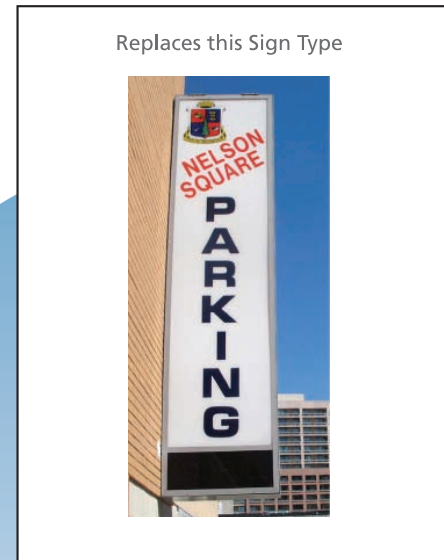

Front View (Two-Sided Sign)

Side View (Two-Sided Sign)

Back View (Two-Sided Sign)

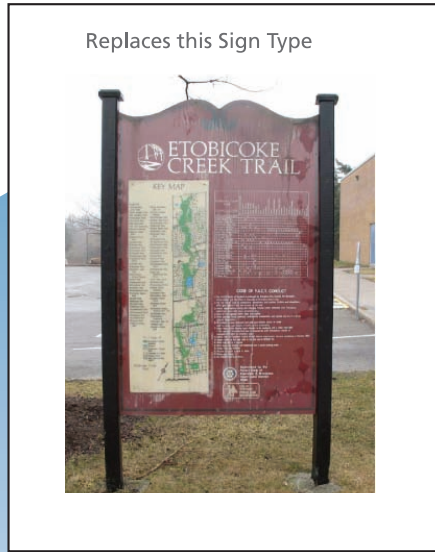

Replaces this Sign Type

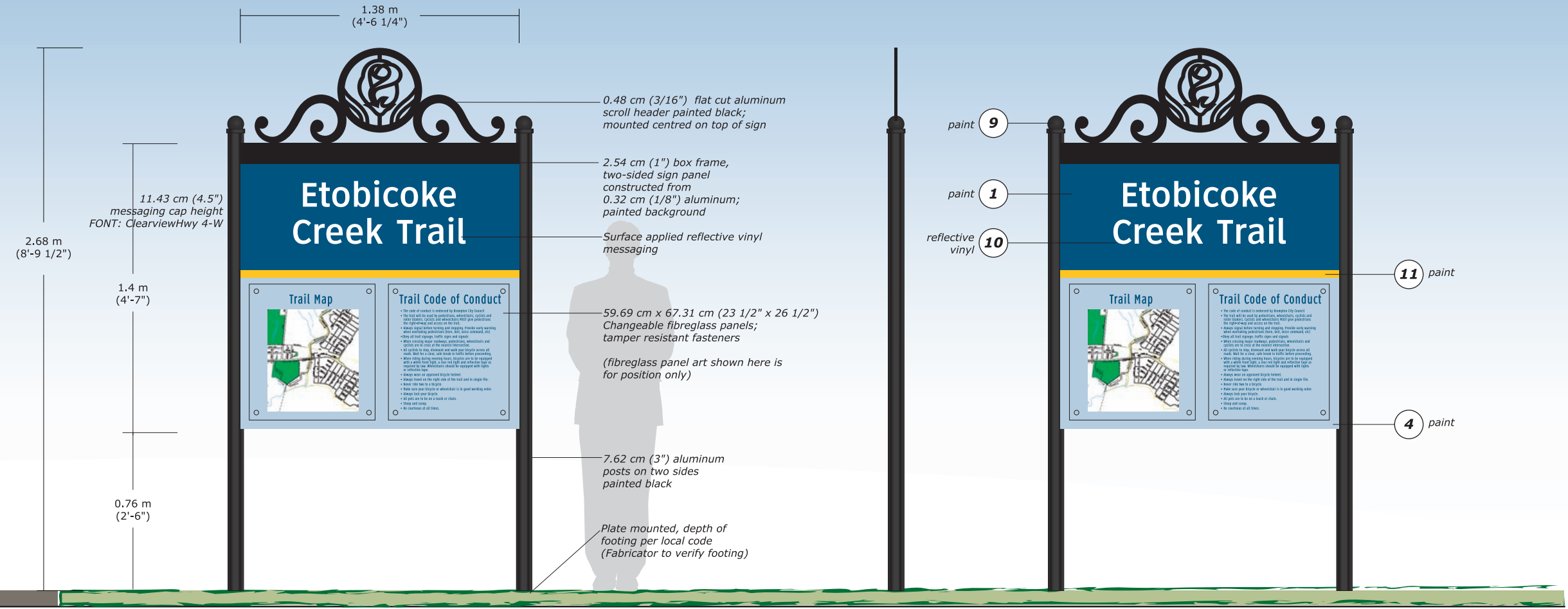

Front View (Two-Sided Sign)

Side View (Two-Sided Sign)

Back View (Two-Sided Sign)

Master Wayfinding Program	Scale	Colour Palette	Notes	Date	Description	Sign Type Array
<p>City of Brampton Brampton, Ontario</p>	<p>1.27 cm = 0.3 m (1/2" = 1'0") (on an 11 x 17 sheet)</p>		<p>This drawing is design-intent only. Fabricator is responsible for fabrication and overall level of quality. Any changes in design, materials, fabrication method or other details must be approved by the Designer and the City of Brampton, Ontario.</p>	<p>08.28.06 02.07.07 06.20.07 04.14.08 05.21.08</p>	<p>Preliminary Sign Type Array Revisions Final Document Design Standards Update Design Standards Update</p>	<p>Trail Identifier post & panel Ix-8</p>

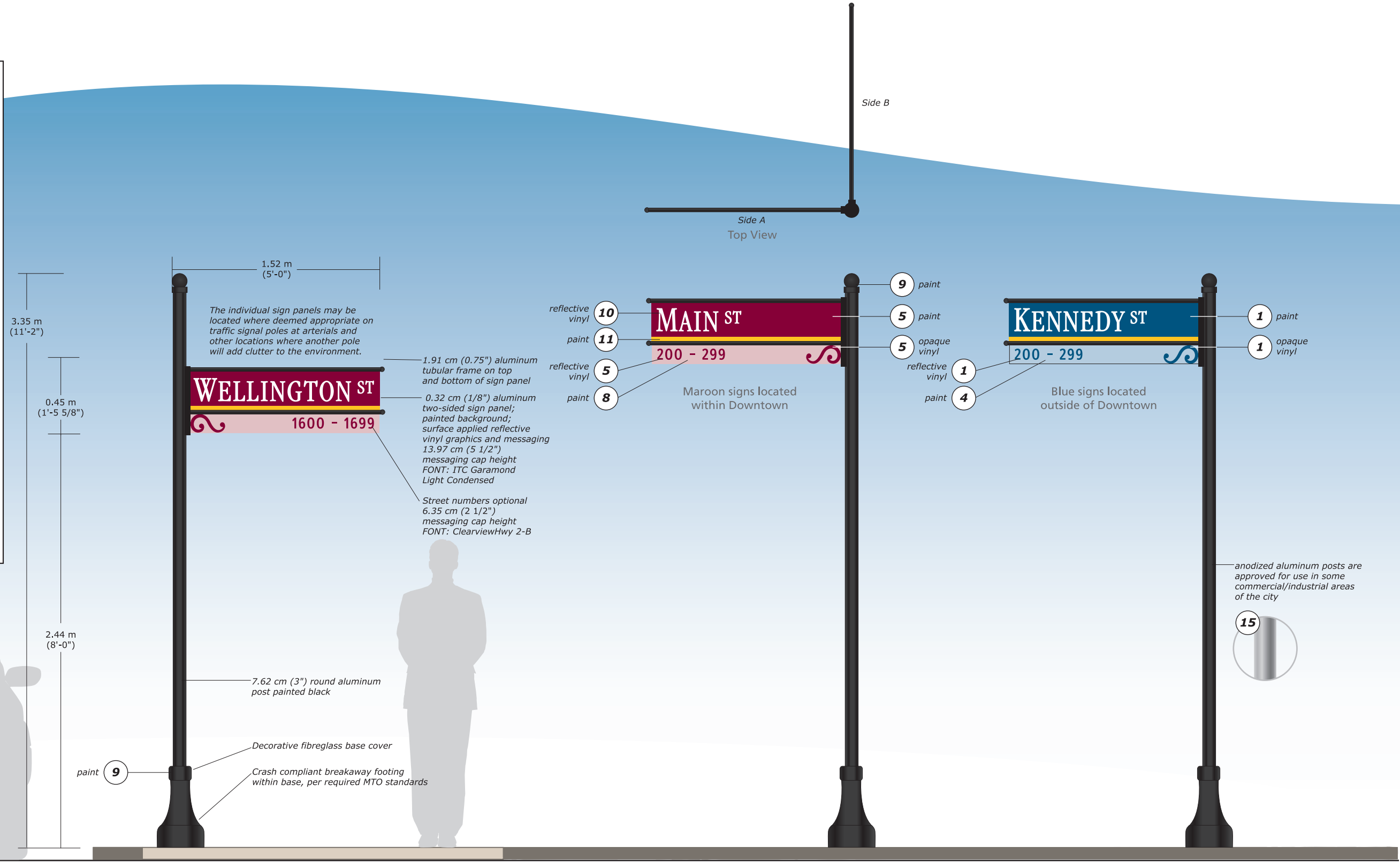

Side A View
(Two-Sided Sign)

Side B View
(Two-Sided Sign)

Master Wayfinding Program	Scale	Colour Palette	Notes	Date	Description	Sign Type Array
<p>City of Brampton Brampton, Ontario</p>	<p>1.27 cm = 0.3 m (1/2" = 1'0") (on an 11 x 17 sheet)</p>		<p>This drawing is design-intent only. Fabricator is responsible for fabrication and overall level of quality. Any changes in design, materials, fabrication method or other details must be approved by the Designer and the City of Brampton, Ontario.</p>	<p>08.28.06 02.07.07 06.20.07 04.14.08 05.21.08</p>	<p>Preliminary Sign Type Array Revisions Final Document Design Standards Update Design Standards Update</p>	<p>Street ID Ix-9</p>

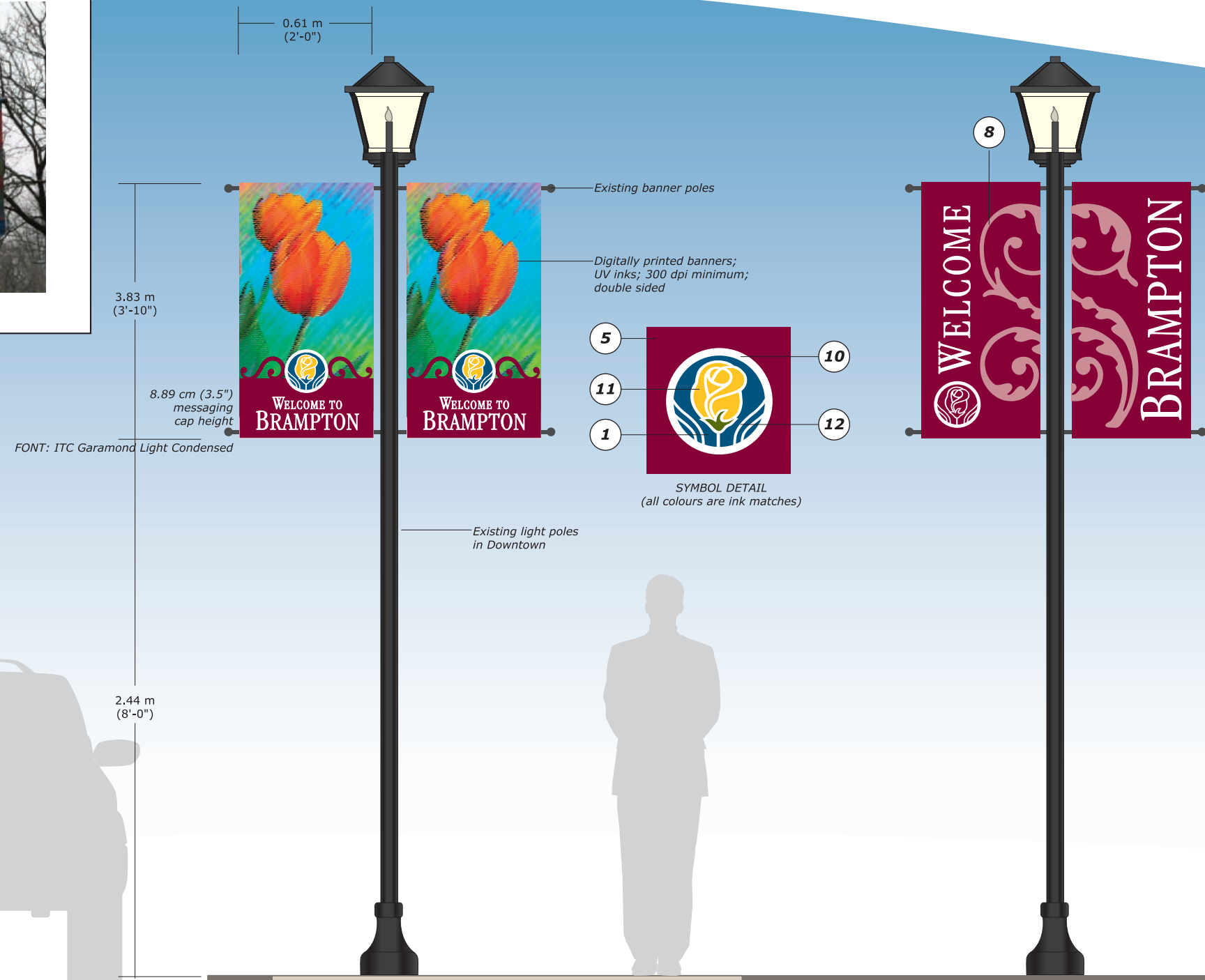

Front View – Design Option A (Two-Sided Sign)

Front View – Design Option B (Two-Sided Sign)

Master Wayfinding Program	Scale	Colour Palette	Notes	Date	Description	Sign Type Array
<p>City of Brampton</p> <p>Brampton, Ontario</p>	<p>1.27 cm = 0.3 m (1/2" = 1'0") (on an 11 x 17 sheet)</p>		<p>This drawing is design-intent only. Fabricator is responsible for fabrication and overall level of quality. Any changes in design, materials, fabrication method or other details must be approved by the Designer and the City of Brampton, Ontario.</p>	<p>08.28.06 02.07.07 06.20.07 04.14.08 05.21.08</p>	<p>Preliminary Sign Type Array Revisions Final Document Design Standards Update Design Standards Update</p>	<p>Banner downtown Ix-10</p>

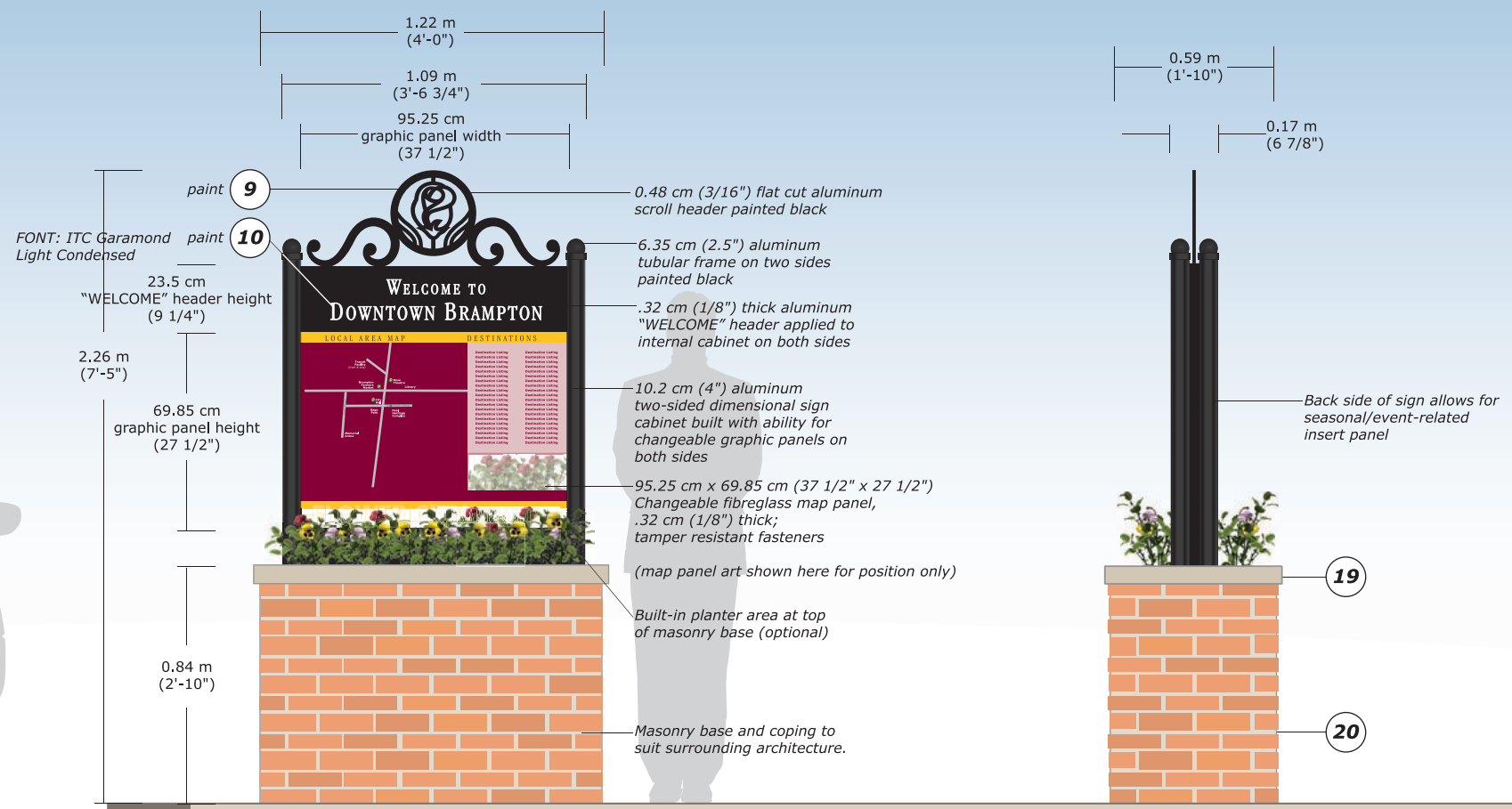

Master Wayfinding Program >
City of Brampton
 Brampton, Ontario

corbindesign
 109 East Front Suite 304
 Traverse City, MI 49684
 231 947.1236

Scale
 1.27 cm = 0.3 m
 (1/2" = 1'0")
 (on an 11 x 17 sheet)

Colour Palette

9 10 19 20

Notes
 This drawing is design-intent only. Fabricator is responsible for fabrication and overall level of quality. Any changes in design, materials, fabrication method or other details must be approved by the Designer and the City of Brampton, Ontario.

Date	Description
08.28.06	Preliminary Sign Type Array
02.07.07	Revisions
06.20.07	Final Document
04.14.08	Design Standards Update
05.21.08	Design Standards Update

Sign Type Array
Pedestrian Map Kiosk
 masonry base
 Dx-1 ★

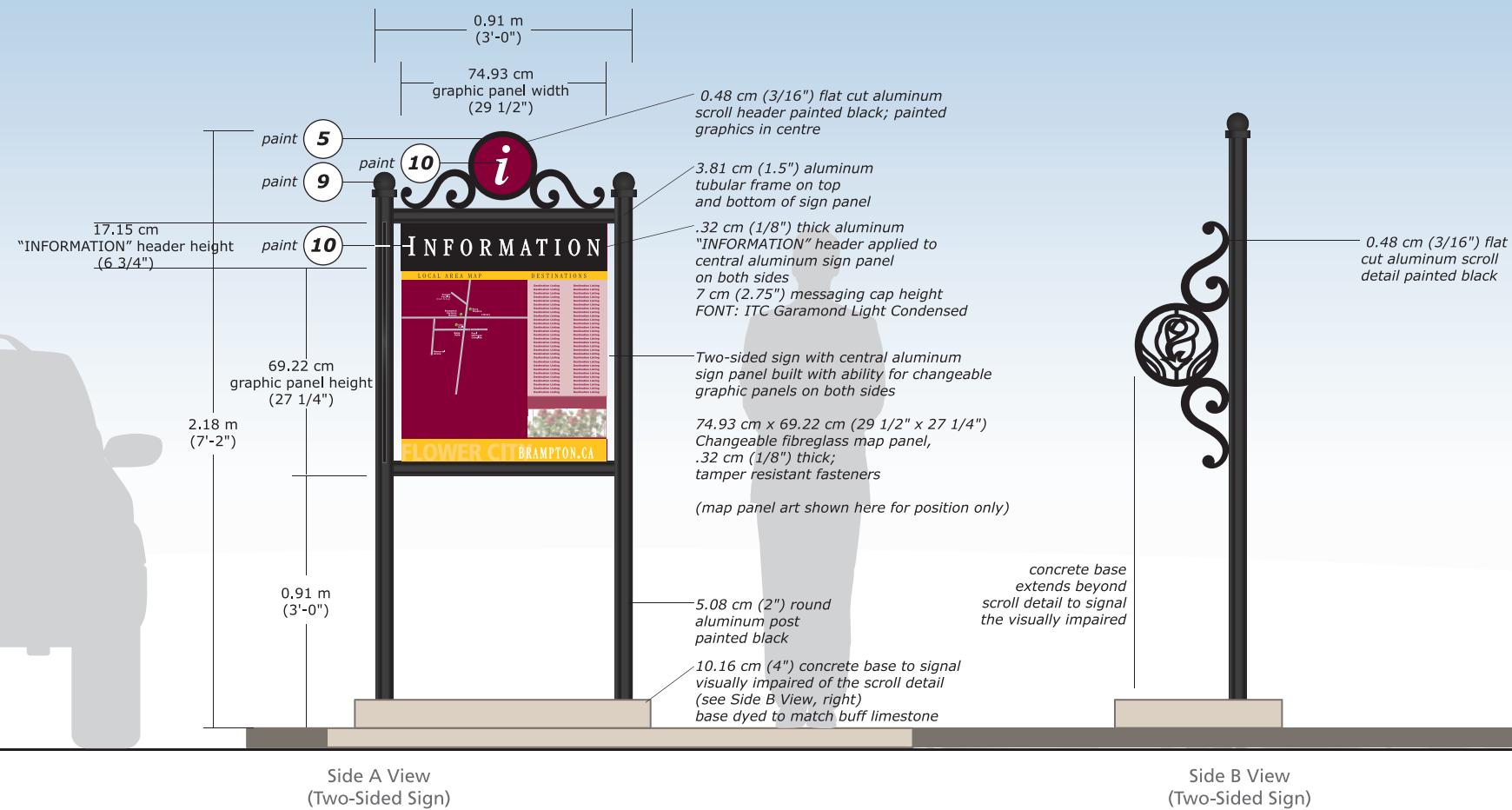
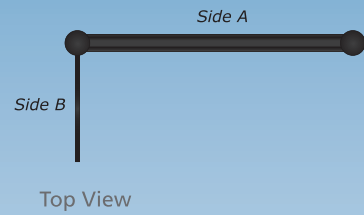

Master Wayfinding Program	Scale	Colour Palette	Notes	Date	Description	Sign Type Array
<p>City of Brampton Brampton, Ontario</p>	<p>1.27 cm = 0.3 m (1/2" = 1'0") (on an 11 x 17 sheet)</p>		<p>This drawing is design-intent only. Fabricator is responsible for fabrication and overall level of quality. Any changes in design, materials, fabrication method or other details must be approved by the Designer and the City of Brampton, Ontario.</p>	<p>08.28.06 02.07.07 06.20.07 04.14.08 05.21.08</p>	<p>Preliminary Sign Type Array Revisions Final Document Design Standards Update Design Standards Update</p>	<p>Pedestrian Map Kiosk post & panel Dx-2 ★</p>

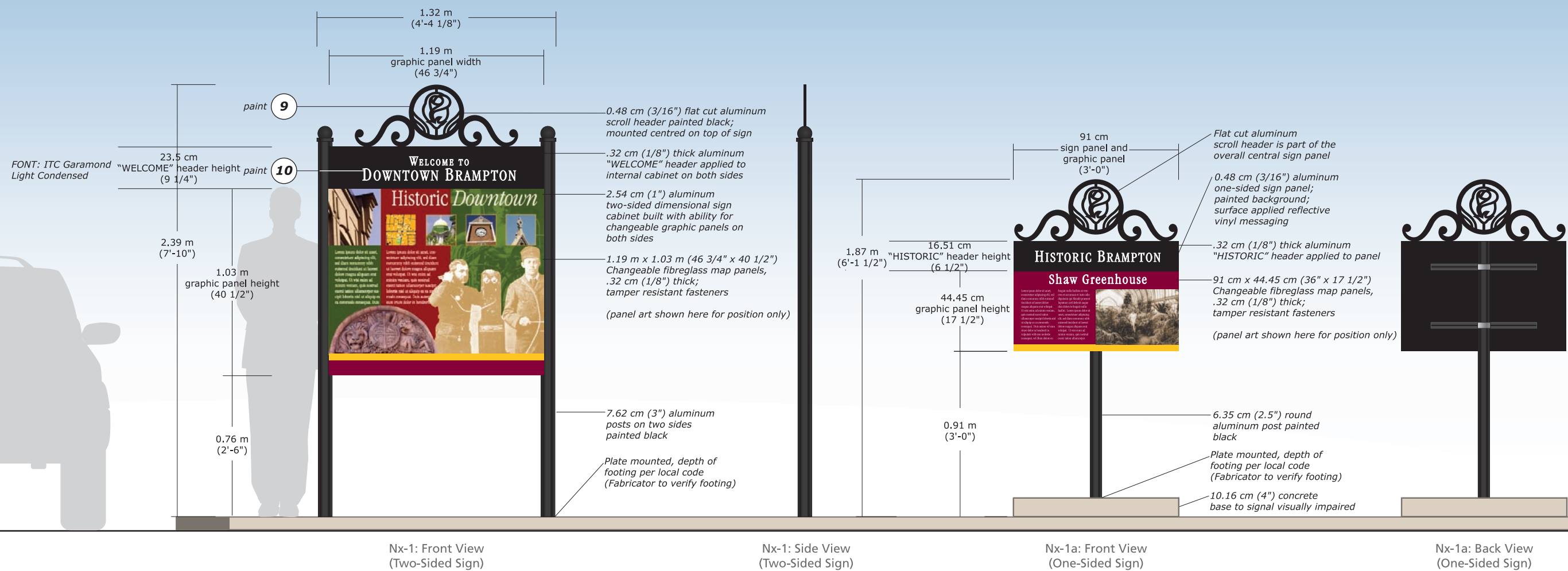

Master Wayfinding Program	Scale	Colour Palette	Notes	Date	Description	Sign Type Array
<p>City of Brampton Brampton, Ontario</p>	<p>1.27 cm = 0.3 m (1/2" = 1'0") (on an 11 x 17 sheet)</p>	<p>9 10</p>	<p>This drawing is design-intent only. Fabricator is responsible for fabrication and overall level of quality. Any changes in design, materials, fabrication method or other details must be approved by the Designer and the City of Brampton, Ontario.</p>	<p>08.28.06 02.07.07 06.20.07 04.14.08 05.21.08</p>	<p>Preliminary Sign Type Array Revisions Final Document Design Standards Update Design Standards Update</p>	<p>Interpretive Sign post & panel Nx-1 large Nx-1a small</p>

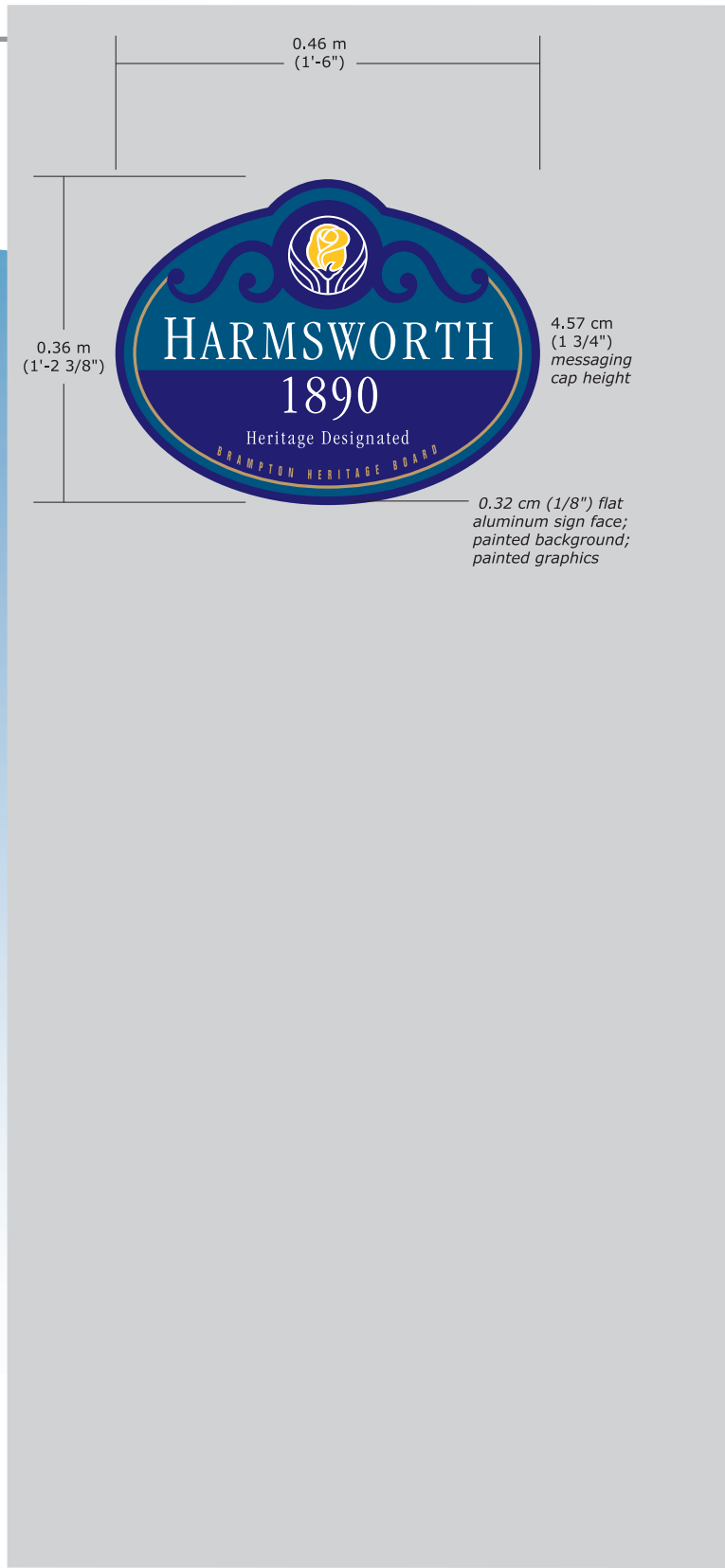

Front View

Side View

Master Wayfinding Program	Scale	Colour Palette	Notes	Date	Description	Sign Type Array
<p>City of Brampton Brampton, Ontario</p>	<p>3.81 cm = 0.3 m (1 1/2" = 1'0") (on an 11 x 17 sheet)</p>		<p>This drawing is design-intent only. Fabricator is responsible for fabrication and overall level of quality. Any changes in design, materials, fabrication method or other details must be approved by the Designer and the City of Brampton, Ontario.</p>	<p>08.28.06 02.07.07 06.20.07 04.14.08 05.21.08</p>	<p>Preliminary Sign Type Array Revisions Final Document Design Standards Update Design Standards Update</p>	<p>Historical Plaque wall mounted Nx-2</p>

corbindesign
109 East Front Suite 304
Traverse City, MI 49684
231 947.1236



Photorendering of Possible Installation

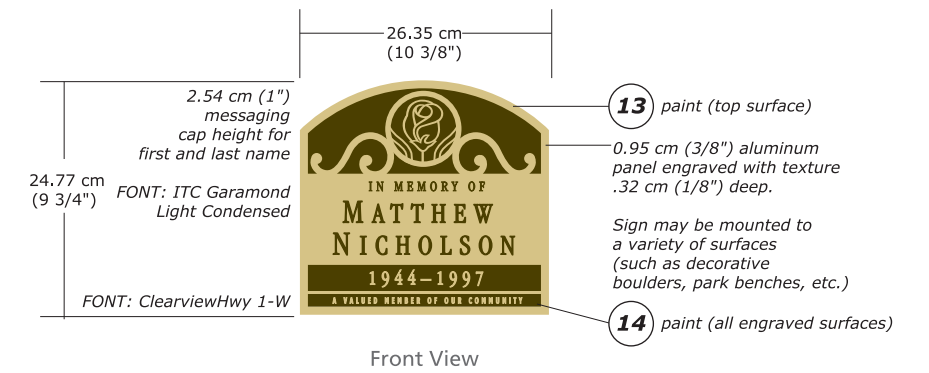

Front View

Master Wayfinding Program	Scale	Colour Palette	Notes	Date	Description	Sign Type Array
<p>City of Brampton</p> <p>Brampton, Ontario</p>	<p>3.81 cm = 0.3 m (1 1/2" = 1'0") (on an 11 x 17 sheet)</p>	<p>13 14</p>	<p>This drawing is design-intent only. Fabricator is responsible for fabrication and overall level of quality. Any changes in design, materials, fabrication method or other details must be approved by the Designer and the City of Brampton, Ontario.</p>	<p>08.28.06 02.07.07 06.20.07 04.14.08 05.21.08</p>	<p>Preliminary Sign Type Array Revisions Final Document Design Standards Update Design Standards Update</p>	<p>Dedicatory Plaque</p> <p>Nx-3</p>



Photorendering of Possible Installation

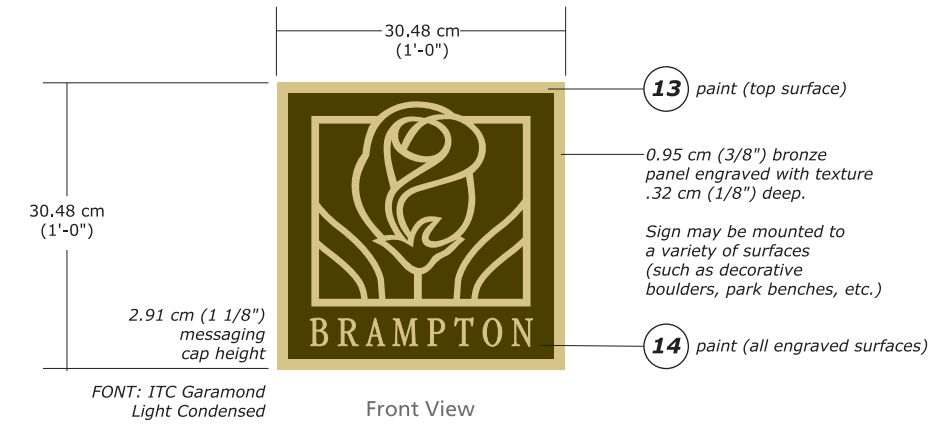

Master Wayfinding Program	Scale	Colour Palette	Notes	Date	Description	Sign Type Array
<p>City of Brampton Brampton, Ontario</p>	<p>3.81 cm = 0.3 m (1 1/2" = 1'0") (on an 11 x 17 sheet)</p>	<p>13 14</p>	<p>This drawing is design-intent only. Fabricator is responsible for fabrication and overall level of quality. Any changes in design, materials, fabrication method or other details must be approved by the Designer and the City of Brampton, Ontario.</p>	<p>08.28.06 02.07.07 06.20.07 04.14.08 05.21.08</p>	<p>Preliminary Sign Type Array Revisions Final Document Design Standards Update Design Standards Update</p>	<p>Developer Monument Sign Plaque Nx-4</p>



Gx-1: Vehicular Guide (LG)

Gx-2: Vehicular Guide (SM)

Gx-3: Trailblazer Guide Sign

Master Wayfinding Program	>	Scale	Notes	Date	Description	Sign Type Array
<p>City of Brampton Brampton, Ontario</p>	<p>corbindesign 109 East Front Suite 304 Traverse City, MI 49684 231 947.1236</p>	<p>1.27 cm = 0.3 m (1/2" = 1'0") (on an 11 x 17 sheet)</p>	<p>This drawing is design-intent only. Fabricator is responsible for fabrication and overall level of quality. Any changes in design, materials, fabrication method or other details must be approved by the Designer and the City of Brampton, Ontario.</p>	<p>08.28.06 02.07.07 06.20.07 04.14.08 05.21.08</p>	<p>Preliminary Sign Type Array Revisions Final Document Design Standards Update Design Standards Update</p>	<p>Sign Type Array</p>



Gx-4: Internal Guide Sign (within facility campus)

Gx-5a: Trail Guide Sign, Large

Gx-5b: Trail Guide Sign, Small

Gx-6a: MTO Guide Sign, Large

Gx-6a: MTO Guide Sign, Small—Downtown Only

Ix-1: City Identifier Sign

Ix-2: Downtown Identifier Sign (masonry, illuminated)

Master Wayfinding Program	Scale	Notes	Date	Description	Sign Type Array
<p>City of Brampton Brampton, Ontario</p>	<p>corbindesign 109 East Front Suite 304 Traverse City, MI 49684 231 947.1236</p>	<p>1.27 cm = 0.3 m (1/2" = 1'0") (on an 11 x 17 sheet)</p> <p>This drawing is design-intent only. Fabricator is responsible for fabrication and overall level of quality. Any changes in design, materials, fabrication method or other details must be approved by the Designer and the City of Brampton, Ontario.</p>	<p>08.28.06 02.07.07 06.20.07 04.14.08 05.21.08</p>	<p>Preliminary Sign Type Array Revisions Final Document Design Standards Update Design Standards Update</p>	<p>Sign Type Array</p>



Ix-3: Facility Identifier Sign (masonry/LED)

Ix-3a: Facility Identifier Sign, Large (masonry/LED)

Ix-4: Facility Identifier Sign (post & panel)

Ix-5: Park Identifier Sign (post & panel)

Master Wayfinding Program	Scale	Notes	Date	Description	Sign Type Array
<p>City of Brampton Brampton, Ontario</p>	<p>corbindesign 109 East Front Suite 304 Traverse City, MI 49684 231 947.1236</p>	<p>This drawing is design-intent only. Fabricator is responsible for fabrication and overall level of quality. Any changes in design, materials, fabrication method or other details must be approved by the Designer and the City of Brampton, Ontario.</p>	<p>08.28.06 02.07.07 06.20.07 04.14.08 05.21.08</p>	<p>Preliminary Sign Type Array Revisions Final Document Design Standards Update Design Standards Update</p>	<p>Sign Type Array</p>



Ix-6: Parking Identifier Sign (post & panel)



Ix-7: Parking Identifier Sign (wall mounted, illuminated)

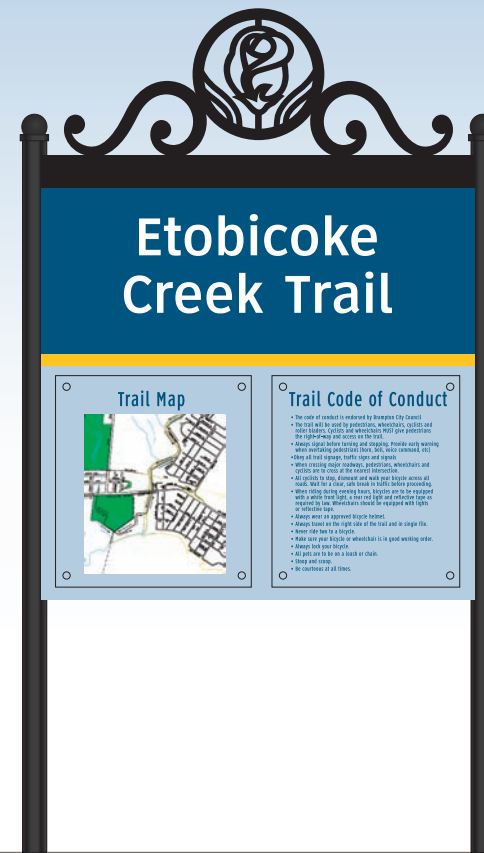

Ix-8: Trail Identifier Sign (post & panel)



Ix-9: Street Identifier

Master Wayfinding Program	Scale	Notes	Date	Description	Sign Type Array
<p>City of Brampton Brampton, Ontario</p>	<p>1.27 cm = 0.3 m (1/2" = 1'0") (on an 11 x 17 sheet)</p>	<p>This drawing is design-intent only. Fabricator is responsible for fabrication and overall level of quality. Any changes in design, materials, fabrication method or other details must be approved by the Designer and the City of Brampton, Ontario.</p>	<p>08.28.06 02.07.07 06.20.07 04.14.08 05.21.08</p>	<p>Preliminary Sign Type Array Revisions Final Document Design Standards Update Design Standards Update</p>	<p>Sign Type Array</p>



Ix-10: Banner (Downtown)

Dx-1: Pedestrian Map Kiosk (masonry base)

Dx-2: Pedestrian Map Kiosk (post & panel)

Nx-1: Interpretive Sign, Large (post & panel)

Nx-1a: Interpretive Sign, Small (post & panel)

Master Wayfinding Program	Scale	Notes	Date	Description	Sign Type Array
<p>City of Brampton Brampton, Ontario</p>	<p>1.27 cm = 0.3 m (1/2" = 1'0") (on an 11 x 17 sheet)</p>	<p>This drawing is design-intent only. Fabricator is responsible for fabrication and overall level of quality. Any changes in design, materials, fabrication method or other details must be approved by the Designer and the City of Brampton, Ontario.</p>	<p>08.28.06 02.07.07 06.20.07 04.14.08 05.21.08</p>	<p>Preliminary Sign Type Array Revisions Final Document Design Standards Update Design Standards Update</p>	<p>Sign Type Array</p>

 109 East Front Suite 304
 Traverse City, MI 49684
 231 947.1236



Nx-2: Historical Plaque
(wall mounted)

Nx-3: Dedicatory Plaque

Nx-4: Developer Monument Sign

Master Wayfinding Program	>	Scale	Notes	Date	Description	Sign Type Array
<p>City of Brampton Brampton, Ontario</p>	<p>corbindesign 109 East Front Suite 304 Traverse City, MI 49684 231 947.1236</p>	<p>3.81 cm = 0.3 m (1 1/2" = 1'0") (on an 11 x 17 sheet)</p>	<p>This drawing is design-intent only. Fabricator is responsible for fabrication and overall level of quality. Any changes in design, materials, fabrication method or other details must be approved by the Designer and the City of Brampton, Ontario.</p>	<p>08.28.06 02.07.07 06.20.07 04.14.08 05.21.08</p>	<p>Preliminary Sign Type Array Revisions Final Document Design Standards Update Design Standards Update</p>	<p>Sign Type Array</p>